

  
**TRU-FLOW**

Dependable Cooling Solutions

# COOLING AND TIMING 4 CATALOGUE

**Edition 4**

▲ INDEX



**WATER PUMPS • FAN CLUTCHES**  
**HEATER TAPS • INTEGRATED THERMOSTAT AND HOUSING**  
**RADIATOR FAN BLADES • TIMING BELT KITS**  
**TIMING BELT / WATER PUMP KITS • TIMING CHAIN KITS**

# TECH SUPPORT

Wherever you are, Motospecs technical support is only a phone call away.

## AUSTRALIA – Tech Support: 1800 245 748

Monday to Friday 8:00am to 5:00pm (EST)

Fax 02 8867 7274

[www.truflow.com.au](http://www.truflow.com.au)

[techsupport@motospecs.com](mailto:techsupport@motospecs.com)

## NEW ZEALAND – Tech Support: 0800 809 808

Monday to Friday 8:00am to 5:00pm

[www.motospecs.co.nz](http://www.motospecs.co.nz)

### WARRANTY

Motospecs recognises the importance of customer confidence and satisfaction in the quality of its products. All Tru-Flow parts are warranted against defects in workmanship or material for a period of 2 years or 40,000kms from the date of sale, whichever ever occurs first, unless otherwise stated. Tru-Flow parts found upon examination by an authorised Motospecs representative to be defective in material or workmanship will be replaced by Motospecs. The cost of returning parts under this warranty must be borne by the customer and must be pre-paid. In order to make a claim under this warranty, the faulty product, proof of purchase and the reason for or details of the failure must be provided to Motospecs.

This warranty does not cover damage by misuse or improper installation, or liability for labour charges or consequential loss or damage incurred as a result of the failure of a Tru-Flow part.

### FOR GOODS PURCHASED IN AUSTRALIA ONLY

Our goods come with guarantees that cannot be excluded under the Australian Consumer Law.

You are entitled to a replacement or refund for a major failure and for compensation for any other reasonably foreseeable loss or damage. You are also entitled to have the goods repaired or replaced if the goods fail to be of acceptable quality and the failure does not amount to a major failure.

### COPYRIGHT NOTICE

Motospecs, a division of GPC Asia Pacific Pty Ltd ABN 97 097 993 283 is the owner of copyright in this publication, including layout, drawings, photographs, text and part number systems. No part of this catalogue may be reproduced or copied in any form or by any means without the prior written permission of Motospecs.

This catalogue has been prepared for the Australian market. Due to vehicle production changes and supersession, you should ensure that the part you are selecting is suitable for your application.





# CONTENTS

## Application Guide

Alfa Romeo. . . . .	2-3
Asia . . . . .	4
Audi . . . . .	4-8
BMW. . . . .	8-15
Chery. . . . .	15
Chrysler. . . . .	16-17
Citroen . . . . .	17-19
Daewoo . . . . .	19-21
Daihatsu . . . . .	21-25
Dodge . . . . .	26
Eunos . . . . .	26
Fiat. . . . .	26
Ford . . . . .	27-44
Great Wall. . . . .	45
Holden . . . . .	45-63
Honda. . . . .	63-68
Hyundai. . . . .	68-73
Isuzu. . . . .	73
Jaguar . . . . .	73
Jeep . . . . .	73-75
Kia . . . . .	75-78
Landrover. . . . .	79-80
Lotus. . . . .	80
Lexus. . . . .	80-82
Mazda . . . . .	82-91
Mercedes Benz. . . . .	92-100
MG. . . . .	100

Mini. . . . .	101
Mitsubishi . . . . .	101-114
Nissan . . . . .	115-125
Peugeot. . . . .	125-127
Proton . . . . .	128
Renault . . . . .	128-129
Rover. . . . .	130
Saab. . . . .	131
Seat . . . . .	132
Skoda. . . . .	132
Ssangyong . . . . .	132-133
Subaru . . . . .	133-136
Suzuki. . . . .	136-140
Toyota. . . . .	140-167
Volkswagen . . . . .	167-173
Volvo. . . . .	173-176

## Identification Guide

Water Pumps. . . . .	177
Fan Clutches . . . . .	216
Radiator Fans. . . . .	223
Thermostat & Housing . . . . .	226
Timing Belt Kits . . . . .	230
Timing Chain Kits . . . . .	239
Heater Valves . . . . .	240

## Troubleshooting Guide. . . . .

Common water pump failures and their causes . . . . .	244
---	-----

Description	Part No	Year & Notes	Engine
<b>ALFA ROMEO</b>			
<b>147 Turbo Diesel</b>		1/06-7/09	4 Cyl 1.9L 937A50
<i>Water Pump</i>	<b>TF8172</b>		
<i>Thermostat &amp; Housing</i>	<b>TTH534</b>		
<b>147</b>		1/01-7/09	4 Cyl 2.0L AR32310
<i>Water Pump</i>	<b>TF8110</b>		
<i>Thermostat &amp; Housing</i>	<b>TTH500</b>		
<b>147 GTA</b>		7/03-4/07	V6 3.2L AR16
<i>Water Pump</i>	<b>TF8404</b>		
<b>156</b>		2/99-10/03	4 Cyl 2.0L AR32310
<i>Water Pump</i>	<b>TF8110</b>		
<i>Thermostat &amp; Housing</i>	<b>TTH500</b>		
<b>156 JTS</b>		8/02-2/07	4 Cyl 2.0L 937A10
<i>Water Pump</i>	<b>TF8110</b>		
<i>Thermostat &amp; Housing</i>	<b>TTH528</b>		
<b>156</b>		2/99-2/07	V6 2.5L AR32405
<i>Water Pump</i>	<b>TF8250</b>		
<b>156</b>		2/99-1/07	V6 3.2L AR16
<i>Water Pump</i>	<b>TF8250</b>		
<i>Thermostat &amp; Housing</i>	<b>TTH521</b>		
<b>159 Turbo Diesel</b>		9/07-on	4 Cyl 1.9L 939A2
<i>Water Pump</i>	<b>TF8172</b>		
<b>159 JTS</b>		6/06-on	4 Cyl 2.2L 939A5
<i>Water Pump</i>	<b>TF8259</b>		
<b>159 JTD Turbo Diesel</b>		6/06-7/09	5 Cyl 2.4L 939A3
<i>Water Pump</i>	<b>TF8172</b>		
<i>Thermostat &amp; Housing</i>	<b>TTH531</b>		
<b>159 JTS</b>		7/06-7/09	V6 3.2L AR16
<i>Water Pump</i>	<b>TF8358</b>		
<b>166</b>		8/99- 1/08	V6 3.0L AR34301, AR36101
<i>Water Pump</i>	<b>TF8250</b>		
<b>Brera</b>		6/06-on	4 Cyl 2.2L 939A5
<i>Water Pump</i>	<b>TF8259</b>		



Description	Part No	Year & Notes	Engine
<b>ALFA ROMEO</b>			
<b>Brera JTS</b>		6/06-on	V6 3.2L AR16
Water Pump	TF8358		
<b>GT</b>		1/05-on	4 Cyl 2.0L 937A10
Water Pump	TF8110		
Thermostat & Housing	TTH528		
<b>GT</b>		6/04-on	V6 3.2L AR16
Water Pump	TF8250		
<b>GTV</b>		7/98-7/05	4 Cyl 2.0L AR16201, 937A10
Water Pump	TF8110		
<b>GTV</b>		6/98-10/03	V6 3.0L AR16102
Water Pump	TF8250		
<b>GTV</b>		10/03-7/05	V6 3.2L 936A0
Water Pump	TF8250		
<b>Mito</b>		7/09-on	4 Cyl 1.4L 199A50, 199A8, 940A2
Water Pump	TF8421		
Thermostat & Housing	TTH537	To 7/10 88 & 110kW Models	
Thermostat & Housing	TTH591	From 8/10 95 & 125kW Models	
<b>Spider</b>		7/98-10/03	4 Cyl 2.0L AR32310
Water Pump	TF8110		
Thermostat & Housing	TTH500		
<b>Spider JTS</b>		10/03-7/05	4 Cyl 2.0L 937A10
Water Pump	TF8110		
Thermostat & Housing	TTH528		
<b>Spider</b>		10/06-on	4 Cyl 2.2L 939A5
Water Pump	TF8259		
<b>Spider JTS</b>		10/06-on	V6 3.2L 936A0
Water Pump	TF8358		
Thermostat & Housing	TTH521		

Description	Part No	Year & Notes	Engine
<b>ASIA</b>			
<b>Combi Diesel</b>		6/93-8/97	6 Cyl 4.1L ZB
<i>Water Pump</i>	<b>TF3014</b>		
<b>Rocsta</b>		7/93-5/00	4 Cyl 1.8L F8
<i>Water Pump</i>	<b>TF2032</b>		
<b>Rocsta Diesel</b>		7/93-5/00	4 Cyl 2.2L R2
<i>Water Pump</i>	<b>TF1018</b>		
<b>AUDI</b>			
<b>80</b>		1/89-8/95	4 Cyl 2.0L AAD, ABK
<i>Water Pump</i>	<b>TF2453</b>		
<b>80</b>		8/92-8/95	V6 2.6L, 2.8L ABC, AAK
<i>Water Pump</i>	<b>TF8135</b>		
<b>90</b>		5/89-7/92	5 Cyl 2.3L 7A, NG
<i>Water Pump</i>	<b>TF8239</b>		
<b>100</b>		1/92-11/94	V6 2.6L, 2.8L ABC, AAH
<i>Water Pump</i>	<b>TF8135</b>		
<b>A3</b>		5/97-1/06	4 Cyl 1.6L AEH, AKL
<i>Water Pump</i>	<b>TF8132</b>		
<b>A3 Attraction</b>		6/04-11/08	4 Cyl 1.6L BGU
<i>Water Pump</i>	<b>TF8132</b>		
<b>A3 incl. Turbo</b>		5/97-7/04	4 Cyl 1.8L AGN, AGU
<i>Water Pump</i>	<b>TF8131</b>		
<b>A3 8P, FSi</b>		1/07-on	4 Cyl 1.8L BYT, BZB
<i>Water Pump</i>	<b>TF8456</b>		
<i>Thermostat Repair Kit &amp; Housing</i>	<b>TTH583</b>		
<b>A3 Ambition, Attraction, FSi Petrol</b>		6/04-5/08	4 Cyl 2.0L BMB
<i>Water Pump</i>	<b>TF8132</b>		
<b>A3 TFSI Petrol Turbo</b>		2/05-12/08	4 Cyl 2.0L AXX
<i>Water Pump</i>	<b>TF8385</b>		
<b>A3 Ambition Turbo Diesel</b>		6/04-10/07	4 Cyl 2.0L BKD
<i>Water Pump</i>	<b>TF8402</b>		

Description	Part No	Year & Notes	Engine
<b>AUDI</b>			
<b>A3</b>		6/04-11/08	V6 3.2L BMJ
Water Pump	TF8310		
<b>A3 TFSi Sportsback</b>		11/08-on	4 Cyl 1.4L CAXC
Water Pump	TF8475		
Thermostat Repair Kit & Housing	TTH584		
<b>A4 incl. Turbo</b>		8/95-on	4 Cyl 1.8L AEB, ADR, AFY, AJL
Water Pump	TF8126	<i>Pump without Housing</i>	
Water Pump	TF4829	<i>Pump with Housing</i>	
<b>A4 B6, B7 Petrol Diesel</b>		10/03-on	4 Cyl 1.8L AVJ, BFB
Water Pump	TF8131		
<b>A4 Avante B6</b>		5/04 -2/05	4 Cyl 1.8L BEX
Water Pump	TF8131		
<b>A4 B8 TFSi</b>		11/08-on	4 Cyl 2.0L CDN
Water Pump	TF8456		
Thermostat Repair Kit & Housing	TTH585		
<b>A4</b>		7/01-5/09	4 Cyl 2.0L ALT
Water Pump	TF8132		
<b>A4 Petrol</b>		5/04-5/08	4 Cyl 2.0L BGB
Water Pump	TF8385		
<b>A4 B7 Turbo Diesel</b>		5/05-8/08	4 Cyl 2.0L BLB
Water Pump	TF8402		
<b>A4 incl. Quattro</b>		2/98-2/05	V6 2.4L AGA, ASN, BDV
Water Pump	TF4762		
<b>A4</b>		8/95-2/98	V6 2.6L ABC
Water Pump	TF4762		
<b>A4</b>		1/97-7/01	V6 2.8L ACK
Water Pump	TF4762		
<b>A4</b>		10/01-on	V6 3.0L ASN
Water Pump	TF8316		
<b>A4</b>		7/06-5/08	V6 3.0L BMK
Water Pump	TF8317		



Description	Part No	Year & Notes	Engine
<b>AUDI</b>			
<b>A4 B7</b>		5/05-1/10	V6 3.1L AUK
<i>Water Pump</i>	<b>TF8317</b>		
<b>A4 B8</b>		5/08-on	4 Cyl 1.8L BYT, BZB
<i>Water Pump</i>	<b>TF8456</b>		
<i>Thermostat Repair Kit &amp; Housing</i>	<b>TTH585</b>		
<b>A6 Petrol Turbo</b>		9/06-on	4 Cyl 2.0L BGB, BDW
<i>Water Pump</i>	<b>TF8385</b>		
<b>A6</b>		11/97-9/04	V6 2.4L AGA
<i>Water Pump</i>	<b>TF4762</b>		
<b>A6</b>		10/04-9/08	V6 2.4L BDW
<i>Water Pump</i>	<b>TF8317</b>		
<b>A6</b>		11/94-2/98	V6 2.6L ABC, ACZ
<i>Water Pump</i>	<b>TF4762</b>		
<b>A6</b>		11/97-1/02	V6 2.8L ACK
<i>Water Pump</i>	<b>TF4762</b>		
<b>A6 Turbo Diesel</b>		10/04-2/09	V6 3.0L BMK
<i>Water Pump</i>	<b>TF8317</b>		
<b>A6 Quattro Petrol</b>		2/02-1/06	V6 3.0L BBJ
<i>Water Pump</i>	<b>TF8316</b>		
<b>A6</b>		6/05-2/09	V6 3.2L AUK
<i>Water Pump</i>	<b>TF8317</b>		
<b>A6</b>		10/04-2/09	V8 4.2L BAT
<i>Water Pump</i>	<b>TF8320</b>		
<b>A8</b>		5/95-1/97	V6 2.8L AAH
<i>Water Pump</i>	<b>TF4762</b>		
<b>A8 FWD</b>		1/97-6/00	V8 3.7L AEW
<i>Water Pump</i>	<b>TF8251</b>		
<b>A8</b>		7/05-on	V12 6.0L BHT
<i>Water Pump</i>	<b>TF8321</b>		

Description	Part No	Year & Notes	Engine
<b>AUDI</b>			
<b>Allroad</b>		4/07-on	V6 3.0L ASB, CDY
<i>Water Pump</i>	<b>TF8310</b>		
<b>Allroad</b>		12/03-10/06	V8 4.2L BAS
<i>Water Pump</i>	<b>TF8320</b>		
<b>Q7 Turbo Diesel</b>		8/06-on	V6 3.0L BUG
<i>Water Pump</i>	<b>TF8317</b>		
<b>Q7 Petrol</b>		10/08-on	V6 3.6L BHK
<i>Water Pump</i>	<b>TF8310</b>		
<b>Q7 Petrol</b>		10/08-on	V8 4.1L BTR
<i>Water Pump</i>	<b>TF8320</b>		
<b>Q7 Turbo Diesel</b>		8/06-on	V8 4.2L BAR
<i>Water Pump</i>	<b>TF8320</b>		
<b>RS4</b>		11/00-on	V6 2.7L ASJ
<i>Water Pump</i>	<b>TF4762</b>		
<b>S2</b>		3/94-4/96	5 Cyl 2.2L 3B
<i>Water Pump</i>	<b>TF8239</b>		
<b>S3 Turbo</b>		11/99-6/04	4 Cyl 1.8L APY
<i>Water Pump</i>	<b>TF8131</b>		
<b>S4 B5 Twin Turbo</b>		12/99-8/03	V6 2.7L AGB
<i>Water Pump</i>	<b>TF4762</b>		
<b>S4 B6, B7</b>		10/03-11/06	V8 4.2L BBK
<i>Water Pump</i>	<b>TF8320</b>		
<b>S6</b>		2/01-5/05	V8 4.2L ABZ
<i>Water Pump</i>	<b>TF8251</b>		
<b>S6 incl. Quattro</b>		2/01-5/05	V8 4.2L ANK
<i>Water Pump</i>	<b>TF8412</b>		
<b>TT incl. Quattro</b>		5/99-10/06	4 Cyl 1.8L APX, AUQ, BAM
<i>Water Pump</i>	<b>TF8131</b>		
<b>TT incl. Quattro</b>		10/06-on	4 Cyl 2.0L BWA
<i>Water Pump</i>	<b>TF8385</b>		

Description	Part No	Year & Notes	Engine
<b>AUDI</b>			
<b>TT Quattro</b>		1/05-on	V6 3.2L BPF,BUB
Water Pump	TF8310		
<b>BMW</b>			
<b>116i E87</b>		1/06-3/08	4 Cyl 1.6L N45B16
Water Pump	TF8287		
Thermostat & Housing	TTH514		
<b>118i E87</b>		10/05-on	4 Cyl 2.0L N46B20
Water Pump	TF8287		
Thermostat & Housing	TTH553		
<b>118D E87, E88</b>		9/09-on	4 Cyl 2.0L N47D20
Water Pump	TF8457		
Thermostat Repair Kit & Housing	TTH586		
<b>120i E87</b>		10/05-on	4 Cyl 2.0L N46B20
Water Pump	TF8287		
Thermostat & Housing	TTH553		
<b>120D E87</b>		9/04-on	4 Cyl 2.0L M47D20
Water Pump	TF8415		
Thermostat & Housing	TTH515		
<b>316i E36</b>		3/95-5/96	4 Cyl 1.6L M43B16
Water Pump	TF3130		
Fan Clutch	TFC104	3 Hole Mounting	
Fan Clutch	TFC238	4 Hole Mounting	
Thermostat & Housing	TTH513		
<b>316i E36</b>		5/96-2/02	4 Cyl 1.9L M43B19TU
Water Pump	TF3130		
<b>316Ti E46</b>		2/02-1/05	4 Cyl 1.8L N42B18
Water Pump	TF8287		
Thermostat & Housing	TTH553		
<b>318i E21</b>		5/83-8/91	4 Cyl 1.8L M10B18
Water Pump	TF2358		
<b>318i E30</b>		5/88-8/94	4 Cyl 1.8L M40B18
Water Pump	TF2671		



Description	Part No	Year & Notes	Engine
<b>BMW</b>			
<b>318i E36</b>		<b>1/91-2/99</b>	<b>4 Cyl 1.8L M40B18</b>
Water Pump	<b>TF3130</b>		
Fan Clutch	<b>TFC104</b>	<i>3 Hole Mounting</i>	
Fan Clutch	<b>TFC238</b>	<i>4 Hole Mounting</i>	
<b>318i E46</b>		<b>8/98-10/01</b>	<b>4 Cyl 1.9L M43B19</b>
Water Pump	<b>TF3130</b>		
Fan Clutch	<b>TFC104</b>		
<b>318i E46</b>		<b>11/01-7/07</b>	<b>4 Cyl 2.0L N42B20, N46B20</b>
Water Pump	<b>TF8287</b>		
Thermostat & Housing	<b>TTH514</b>	<i>To 12/01</i>	
Thermostat & Housing	<b>TTH553</b>	<i>From 1/02</i>	
<b>318is E30</b>		<b>7/90-3/91</b>	<b>4 Cyl 1.8L M42B18</b>
Water Pump	<b>TF2671</b>		
<b>318is E36</b>		<b>5/92-1/97</b>	<b>4 Cyl 1.8L M42B18</b>
Water Pump	<b>TF8325</b>		
<b>318is, 318Ti E36</b>		<b>6/96-6/00</b>	<b>4 Cyl 1.9L M44B19</b>
Water Pump	<b>TF3130</b>		
Fan Clutch	<b>TFC104</b>		
Thermostat & Housing	<b>TTH527</b>		
<b>318Ti E46</b>		<b>10/01-7/05</b>	<b>4 Cyl 2.0L N42B20</b>
Water Pump	<b>TF8287</b>		
Thermostat & Housing	<b>TTH553</b>		
<b>320i E30</b>		<b>2/88-3/90</b>	<b>6 Cyl 2.0L M20B20</b>
Water Pump	<b>TF2646</b>		
<b>320i E36</b>		<b>4/91-12/95</b>	<b>6 Cyl 2.0L M50B20</b>
Water Pump	<b>TF2735</b>		
<b>320i E46</b>		<b>6/02-2/06</b>	<b>6 Cyl 2.2L M54B22</b>
Water Pump	<b>TF2735</b>		
Fan Clutch	<b>TFC104</b>		
Thermostat & Housing	<b>TTH551</b>		
<b>320i E90</b>		<b>1/06-10/08</b>	<b>4 Cyl 2.0L N46B20</b>
Water Pump	<b>TF8287</b>		
Thermostat & Housing	<b>TTH553</b>		

Description	Part No	Year & Notes	Engine
<b>BMW</b>			
<b>320ci E46</b>		5/04-9/06	6 Cyl 2.2L M54B22
Water Pump	TF2735		
Thermostat & Housing	TTH551		
<b>320D E90</b>		2/06-on	4 Cyl 2.0L M47N2204D4
Water Pump	TF8457		
Thermostat & Housing	TTH515		
<b>320D E90 Turbo Diesel</b>		2/06-on	4 Cyl 2.0L N47D20C
Water Pump	TF8416		
<b>323i E21</b>		6/79-5/83	6 Cyl 2.3L M20B23
Water Pump	TF2154	<i>From 1982</i>	
Fan Clutch	TFC104	<i>All</i>	
<b>323i E30</b>		11/83-12/85	6 Cyl 2.3L M20B23
Water Pump	TF2154		
<b>323i E36</b>		1/96-8/98	6 Cyl 2.5L M52B25
Water Pump	TF2735		
Fan Clutch	TFC104		
<b>323i, 323Ci E46</b>		2/99-4/00	6 Cyl 2.5L M52B25
Water Pump	TF2735		
Thermostat & Housing	TTH551		
<b>323i E90</b>		2/06-3/07	6 Cyl 2.5L N52B25
Water Pump	TF8397		
<b>325E E30</b>		1/86-12/87	6 Cyl 2.7L M20B27
Water Pump	TF2154		
Fan Clutch	TFC104		
<b>325i, 325is E30</b>		1/88-3/91	6 Cyl 2.5L M20B25
Water Pump	TF2646		
<b>325i E36</b>		5/91-6/95	6 Cyl 2.5L M50B25
Water Pump	TF2735		
Fan Clutch	TFC104		
<b>325i E46</b>		11/00-5/05	6 Cyl 2.5L M54B25
Water Pump	TF2735		
Fan Clutch	TFC104		
Thermostat & Housing	TTH551		

Description	Part No	Year & Notes	Engine
<b>BMW</b>			
<b>325i E90, E92</b>		1/06-on	6 Cyl 2.5L N52B25AF
<i>Water Pump</i>	<b>TF8397</b>		
<b>325Ci, 325Ti E46</b>		5/02-4/07	6 Cyl 2.5L M54B25
<i>Water Pump</i>	<b>TF2735</b>		
<i>Fan Clutch</i>	<b>TFC104</b>		
<i>Thermostat &amp; Housing</i>	<b>TTH551</b>		
<b>328i E36</b>		6/93-9/00	6 Cyl 2.8L M52B28
<i>Water Pump</i>	<b>TF2735</b>		
<i>Fan Clutch</i>	<b>TFC104</b>		
<b>328i E46</b>		1/97-9/00	6 Cyl 2.8L M52B28
<i>Water Pump</i>	<b>TF2735</b>		
<i>Fan Clutch</i>	<b>TFC104</b>		
<i>Thermostat &amp; Housing</i>	<b>TTH551</b>		
<b>328Ci E46</b>		1/97-9/00	6 Cyl 2.8L M52B28
<i>Water Pump</i>	<b>TF2735</b>		
<i>Fan Clutch</i>	<b>TFC104</b>		
<i>Thermostat &amp; Housing</i>	<b>TTH551</b>		
<b>330i E46</b>		1/01-5/05	6 Cyl 3.0L M54B30
<i>Water Pump</i>	<b>TF2735</b>		
<i>Fan Clutch</i>	<b>TFC104</b>		
<i>Thermostat &amp; Housing</i>	<b>TTH551</b>		
<b>330i E90</b>		1/06-on	6 Cyl 3.0L N54B30A
<i>Water Pump</i>	<b>TF8397</b>		
<b>330Ci E46</b>		9/00-2/07	6 Cyl 3.0L M54B30
<i>Water Pump</i>	<b>TF2735</b>		
<i>Fan Clutch</i>	<b>TFC104</b>		
<i>Thermostat &amp; Housing</i>	<b>TTH551</b>		
<b>335i E90, E92 Turbo Petrol</b>		1/10-on	6 Cyl 3.0L N54B30A
<i>Water Pump</i>	<b>TF8488</b>		
<b>520i E28</b>		3/83-12/85	6 Cyl 2.0L M20B20
<i>Water Pump</i>	<b>TF2154</b>		
<i>Fan Clutch</i>	<b>TFC104</b>		



Description	Part No	Year & Notes	Engine
<b>BMW</b>			
<b>520i E34</b>		11/90-3/96	6 Cyl 2.0L M50B20
Water Pump	TF2735		
Fan Clutch	TFC104		
<b>523i E39</b>		4/96-11/00	6 Cyl 2.5L M52B25
Water Pump	TF2735		
Fan Clutch	TFC104		
Thermostat & Housing	TTH551	<i>From 10/98</i>	
<b>525i E34</b>		9/88-10/90	6 Cyl 2.5L M20B25
Water Pump	TF2646		
<b>525i E34</b>		9/88-10/90	6 Cyl 2.5L M50B25
Fan Clutch	TFC104		
<b>525i E39</b>		1/01-10/03	6 Cyl 2.5L M52B25
Water Pump	TF2735		
Thermostat & Housing	TTH551		
<b>525i E60</b>		10/03-5/05	6 Cyl 2.5L M54B25
Water Pump	TF2735		
<b>525E E28</b>		1/86-8/88	6 Cyl 2.7L M20B7
Water Pump	TF2154		
Fan Clutch	TFC104		
<b>528, 528i E12, E28</b>		1975-12/85	6 Cyl 2.8L M30B28
Water Pump	TF2477		
<b>528i E39</b>		5/96-1/01	6 Cyl 2.8L M52B28
Water Pump	TF2735		
Thermostat & Housing	TTH551		
<b>530i E39, E60</b>		3/01-5/05	6 Cyl 3.0L M54B30
Water Pump	TF2735		
Thermostat & Housing	TTH551		
<b>530i E61</b>		3/05-on	6 Cyl 3.0L N52B30
Water Pump	TF2735		
<b>535i E34</b>		9/88-5/93	6 Cyl 3.4L M30B35
Water Pump	TF2477		
Fan Clutch	TFC104		

Description	Part No	Year & Notes	Engine
<b>BMW</b>			
<b>535i E39</b>		12/96-10/03	V8 3.5L M62B35
<i>Water Pump</i>	<b>TF8460</b>		
<b>535is E34</b>		6/89-12/90	6 Cyl 3.4L M30B35
<i>Water Pump</i>	<b>TF2477</b>		
<b>540i E39</b>		12/96-10/03	V8 4.4L M62B35
<i>Water Pump</i>	<b>TF8460</b>		
<b>730i E32 SOHC</b>		11/90-5/93	6 Cyl 3.0L M30B30
<i>Water Pump</i>	<b>TF2477</b>		
<b>735i E23</b>		5/83-2/84	6 Cyl 3.2L M30B35
<i>Water Pump</i>	<b>TF2477</b>		
<b>735i E65</b>		2/02-3/05	V8 3.6L N62B36
<i>Water Pump</i>	<b>TF8286</b>		
<b>735i, 735iL E23, E32</b>		3/85-11/92	6 Cyl 3.4L M30B35
<i>Water Pump</i>	<b>TF2477</b>		
<b>735i E38</b>		1/99-1/02	V8 3.5L M62B35
<i>Water Pump</i>	<b>TF8258</b>		
<b>735iL E38</b>		11/98-12/00	V8 3.5L M62B35
<i>Water Pump</i>	<b>TF8258</b>		
<b>740iL E38</b>		6/96-1/02	V8 4.4L M62B44
<i>Water Pump</i>	<b>TF8460</b>		
<b>745i, 745iL E65, E66</b>		2/02-3/05	V8 4.4L N62B44
<i>Water Pump</i>	<b>TF8286</b>		
<b>750iL E38</b>		11/94-01/01	V12 5.4L M73B54
<i>Water Pump</i>	<b>TF8252</b>		
<b>840Ci E31</b>		1/96-1/00	V8 4.4L M62B44
<i>Water Pump</i>	<b>TF8460</b>		
<b>850i, 850ci E31</b>		7/90-1/93	V12 5.0L M70B50
<i>Water Pump</i>	<b>TF8252</b>		
<b>M3 E36</b>		4/96-1/00	6 Cyl 3.2L S50B32
<i>Water Pump</i>	<b>TF8388</b>		

Description	Part No	Year & Notes	Engine
<b>BMW</b>			
<b>M3 E46</b>		01/01-9/06	6 Cyl 3.2L S54B32
<i>Water Pump</i>	<b>TF8462</b>		
<b>M5 E34</b>		7/90-5/93	6 Cyl 3.5L S38B36
<i>Water Pump</i>	<b>TF2477</b>		
<b>X3 E83 Turbo Diesel</b>		1/07-on	4 Cyl 2.0L N47D20A
<i>Water Pump</i>	<b>TF8457</b>		
<i>Thermostat Repair Kit &amp; Housing</i>	<b>TTH586</b>		
<b>X3 E83</b>		7/05-on	6 Cyl 2.5L M54B25
<i>Water Pump</i>	<b>TF2735</b>		
<i>Thermostat &amp; Housing</i>	<b>TTH551</b>		
<b>X3 E83 MPFi</b>		7/05-on	6 Cyl 3.0L M54B30
<i>Water Pump</i>	<b>TF2735</b>		
<i>Thermostat &amp; Housing</i>	<b>TTH551</b>		
<b>X5 E53 Turbo Diesel</b>		3/03-12/03	6 Cyl 2.9L M57306D1
<i>Water Pump</i>	<b>TF8381</b>		
<i>Thermostat &amp; Housing</i>	<b>TTH587</b>		
<b>X5 E53 MPFi</b>		3/01-3/07	6 Cyl 3.0L M54B30
<i>Water Pump</i>	<b>TF2735</b>		
<i>Thermostat &amp; Housing</i>	<b>TTH551</b>		
<b>X5 E53 Turbo Diesel</b>		1/04-3/07	6 Cyl 3.0L M57D30
<i>Water Pump</i>	<b>TF8380</b>		
<i>Thermostat &amp; Housing</i>	<b>TTH515</b>		
<b>X5 E70 Turbo Diesel</b>		3/07-on	6 Cyl 3.0L M57306D3
<i>Water Pump</i>	<b>TF8416</b>		
<i>Thermostat &amp; Housing</i>	<b>TTH515</b>		
<b>X5 E70 Turbo Diesel</b>		1/10-4/12	6 Cyl 3.0L M57D30
<i>Water Pump</i>	<b>TF8491</b>		
<b>X5 E53</b>		11/00-3/07	V8 4.4L M62B44
<i>Water Pump</i>	<b>TF8258</b>		
<b>X5 E53, E70</b>		1/05-3/07	V8 4.8L N62B48
<i>Water Pump</i>	<b>TF8286</b>		

Description	Part No	Year & Notes	Engine
<b>BMW</b>			
<b>Z3 E36</b>		1/97-6/99	4 Cyl 1.9L M44B19
Water Pump	TF3130		
Thermostat & Housing	TTH527		
<b>Z3 E36</b>		6/99-10/00	6 Cyl 2.0L M52B20
Water Pump	TF2735		
Thermostat & Housing	TTH551		
<b>Z3 E36</b>		10/00-3/03	6 Cyl 2.2L M54B22
Water Pump	TF2735		
<b>Z3</b>		9/97-10/00	6 Cyl 2.8L M52B28
Water Pump	TF2735		
Thermostat & Housing	TTH551	<i>From 9/98</i>	
<b>Z3 E36</b>		4/02-3/03	6 Cyl 3.0L M54B30
Water Pump	TF2735		
<b>Z3 Coupe</b>		11/98-1/03	6 Cyl 3.2L M50
Water Pump	TF8388		
<b>Z4 E85</b>		1/03-1/09	6 Cyl 2.5L M54B25
Water Pump	TF2735		
Thermostat & Housing	TTH551		
<b>Z4 E85</b>		1/03-1/10	6 Cyl 3.0L M54B30
Water Pump	TF2735		
Thermostat & Housing	TTH551		
<b>Z4 E86</b>		1/07-1/10	6 Cyl 3.0L N52B30
Water Pump	TF8397		
<b>CHERY</b>			
<b>J1 S2X</b>		03/11-on	4 Cyl 1.3L SQRF
Water Pump	TF8467		
<b>J3</b>		09/11-on	4 Cyl 1.6L SQR473FFF
Water Pump	TF8467		
<b>J11 T1X</b>		03/11-on	4 Cyl 2.0L SQR484FAF9
Water Pump	TF8468		



Description	Part No	Year & Notes	Engine
<b>CHRYSLER</b>			
<b>300C CRD LE</b>		<b>5/06-on</b>	<b>6 Cyl 3.0L</b>
<i>Water Pump</i>	<b>TF8431</b>	<i>7 Rib Pulley</i>	
<b>300C</b>		<b>11/05-12/09</b>	<b>V6 3.5L</b>
<i>Water Pump</i>	<b>TF8197</b>		
<b>300C</b>		<b>11/05-12/09</b>	<b>V8 5.7L</b>
<i>Water Pump</i>	<b>TF8395</b>		
<b>300C</b>		<b>11/05-2/09</b>	<b>V8 6.1L</b>
<i>Water Pump</i>	<b>TF8395</b>		
<b>Centura KB, KC</b>		<b>4/75-6/78</b>	<b>6 Cyl 3.5L, 4.0L Hemi</b>
<i>Water Pump</i>	<b>TF802</b>		
<b>Crossfire ZH</b>		<b>8/03-12/08</b>	<b>V6 3.2L M112.947, M11.2962</b>
<i>Water Pump</i>	<b>TF8400</b>		
<b>Galant GA, GB, GC, GD</b>		<b>8/71-12/78</b>	<b>4 Cyl 1.3L, 1.5L, 1.6L 4G30, 4G31, 4G32</b>
<i>Water Pump</i>	<b>TF822</b>		
<b>Lancer LA, LB</b>		<b>9/74-2/80</b>	<b>4 Cyl 1.4L 4G33</b>
<i>Water Pump</i>	<b>TF822</b>		
<b>Lancer LB, LC</b>		<b>4/77-8/81</b>	<b>4 Cyl 1.6L 4G32</b>
<i>Water Pump</i>	<b>TF1014</b>		
<b>Neon</b>		<b>7/96-7/02</b>	<b>4 Cyl 2.0L S4RE, YD5</b>
<i>Water Pump</i>	<b>TF4102</b>		
<b>PT Cruiser</b>		<b>7/00-11/04</b>	<b>4 Cyl 2.0L 1T</b>
<i>Water Pump</i>	<b>TF4102</b>		
<b>PT Cruiser</b>		<b>11/04-on</b>	<b>4 Cyl 2.4L 1C,5T, 6T</b>
<i>Water Pump</i>	<b>TF8355</b>		
<b>Valiant RVI, SV1, AP5, AP6, VC -VF</b>		<b>1/62-5/70</b>	<b>6 Cyl 225ci Slant</b>
<i>Water Pump</i>	<b>TF578</b>		
<b>Valiant VG, VH, VJ, VK</b>		<b>5/70-76</b>	<b>6 Cyl All Hemi</b>
<i>Water Pump</i>	<b>TF802</b>		
<b>Valiant CH, CJ, CK, CL, CM</b>		<b>1971-6/81</b>	<b>6 Cyl All Hemi</b>
<i>Water Pump</i>	<b>TF802</b>		

Description	Part No	Year & Notes	Engine
<b>CHRYSLER</b>			
<b>Valiant VG, VH, VJ, VK</b>		<b>5/70-76</b>	<b>V8 All</b>
Water Pump	<b>TF806</b>	<i>Without Air Conditioning or Thermal Drive</i>	
<b>Valiant CH, CL, CM</b>		<b>1971-6/81</b>	<b>V8 All</b>
Water Pump	<b>TF806</b>	<i>Without Air Conditioning or Thermal Drive</i>	
<b>Voyager RS, RG</b>		<b>2/97-3/08</b>	<b>V6 3.3L A4</b>
Water Pump	<b>TF8104</b>	<i>To 5/01 Round Hub without Welch Plug</i>	
Water Pump	<b>TF8293</b>	<i>From 6/01 Clover Hub with Welch Plug</i>	
<b>CITROEN</b>			
<b>AX</b>		<b>1/91-12/93</b>	<b>4 Cyl 1.4L KDZ</b>
Water Pump	<b>TF8100</b>		
<b>Berlingo</b>		<b>7/99-on</b>	<b>4 Cyl 1.4L JP, GJ, KF</b>
Water Pump	<b>TF8235</b>	<i>To 10/02 Pump with 20 Spline</i>	
Water Pump	<b>TF8330</b>	<i>From 11/02 Pump with 18 Teeth</i>	
<b>BX</b>		<b>1/86-1/88</b>	<b>4 Cyl 1.6L</b>
Water Pump	<b>TF3141</b>		
<b>BX</b>		<b>1/86-1/95</b>	<b>4 Cyl 1.9L</b>
Water Pump	<b>TF4028</b>		
<b>C2</b>		<b>2/04-9/08</b>	<b>4 Cyl 1.6L TU5JP4</b>
Water Pump	<b>TF8136</b>		
<b>C3</b>		<b>10/02-3/10</b>	<b>4 Cyl 1.4L TU3JP</b>
Water Pump	<b>TF8330</b>	<i>Pump with 18 Teeth Spline</i>	
Thermostat & Housing	<b>TTH523</b>		
<b>C3</b>		<b>9/03-on</b>	<b>4 Cyl 1.6L TU5JP4</b>
Water Pump	<b>TF8136</b>		
Thermostat & Housing	<b>TTH523</b>		
<b>C4</b>		<b>3/05-3/09</b>	<b>4 Cyl 1.6L TU5JP4</b>
Water Pump	<b>TF8136</b>		
Thermostat & Housing	<b>TTH503</b>	<i>To Chassis No. 10436</i>	
Thermostat & Housing	<b>TTH532</b>	<i>From Chassis No. 10437</i>	

Description	Part No	Year & Notes	Engine
<b>CITROEN</b>			
<b>C4 Turbo Diesel</b>		<b>3/09-on</b>	<b>4 Cyl 1.6L DV6ATED4</b>
Water Pump	<b>TF8417</b>		
Thermostat & Housing	<b>TTH541</b>	<i>From Chassis No. 11167</i>	
<b>C4</b>		<b>4/05-3/09</b>	<b>4 Cyl 2.0L EW10J4S</b>
Water Pump	<b>TF8328</b>		
Thermostat & Housing	<b>TTH512</b>		
<b>C4</b>		<b>3/05-5/09</b>	<b>4 Cyl 2.0L EW10A</b>
Water Pump	<b>TF8138</b>	<i>Without Housing 55mm impeller</i>	
Water Pump	<b>TF8430</b>	<i>With Housing</i>	
Thermostat & Housing	<b>TTH512</b>	<i>From Chassis No. 11074</i>	
<b>C4 Turbo Diesel</b>		<b>1/07-on</b>	<b>4 Cyl 2.0L DW10BTED4</b>
Water Pump	<b>TF8382</b>		
Thermostat & Housing	<b>TTH543</b>	<i>From Chassis No. 10290</i>	
<b>C5</b>		<b>6/01-11/08</b>	<b>4 Cyl 2.0L EW10J4</b>
Water Pump	<b>TF8138</b>	<i>Without Housing 55mm impeller</i>	
Water Pump	<b>TF8430</b>	<i>With Housing</i>	
Thermostat & Housing	<b>TTH512</b>		
<b>C5 Turbo Diesel</b>		<b>6/03-7/05</b>	<b>4 Cyl 2.0L DW10ATED</b>
Water Pump	<b>TF8137</b>		
<b>C5 Turbo Diesel</b>		<b>6/06-on</b>	<b>4 Cyl 2.0L DW10BTED4</b>
Water Pump	<b>TF8137</b>		
Thermostat & Housing	<b>TTH543</b>	<i>From Chassis No. 10339</i>	
<b>C5 Turbo Diesel</b>		<b>3/07-9/08</b>	<b>4 Cyl 2.2L DW12BTED4</b>
Water Pump	<b>TF8429</b>		
Thermostat & Housing	<b>TTH542</b>		
<b>C5</b>		<b>7/05-2/08</b>	<b>V6 2.9L ES9A</b>
Water Pump	<b>TF8329</b>		
<b>C5</b>		<b>6/01-7/05</b>	<b>V6 3.0L ES9J4S</b>
Water Pump	<b>TF8329</b>		
<b>C6</b>		<b>8/06-9/08</b>	<b>V6 2.9L ES9A</b>
Water Pump	<b>TF8329</b>		

Description	Part No	Year & Notes	Engine
<b>CITROEN</b>			
<b>Dispatch Turbo Diesel</b>		<b>4/08-on</b>	<b>4 Cyl 2.0L DW10UTED</b>
Water Pump	<b>TF8382</b>		
Thermostat & Housing	<b>TTH543</b>		
<b>Xantia Sohc</b>		<b>2/97-10/99</b>	<b>4 Cyl 1.9L XUD9TE</b>
Water Pump	<b>TF8401</b>	<i>To Vin No. 07389</i>	
<b>Xantia Sohc</b>		<b>9/94-3/98</b>	<b>4 Cyl 2.0L XU10J2C</b>
Water Pump	<b>TF4028</b>		
<b>Xantia Dohc</b>		<b>11/96-6/02</b>	<b>4 Cyl 2.0L XU10J4R</b>
Water Pump	<b>TF8101</b>		
<b>Xsara Sohc</b>		<b>2/00-2/01</b>	<b>4 Cyl 1.6L TU5JP</b>
Water Pump	<b>TF8100</b>		
<b>Xsara Dohc</b>		<b>2/01-3/06</b>	<b>4 Cyl 1.6L TU5JP4</b>
Water Pump	<b>TF8136</b>		
<b>Xsara</b>		<b>2/01-3/06</b>	<b>4 Cyl 2.0L EW10J4</b>
Water Pump	<b>TF8138</b>	<i>Without Housing 55mm impeller</i>	
Water Pump	<b>TF8430</b>	<i>With Housing</i>	
<b>Xsara</b>		<b>8/98-3/06</b>	<b>4 Cyl 2.0L XU10J4</b>
Water Pump	<b>TF8101</b>		
Thermostat & Housing	<b>TTH512</b>		
<b>DAEWOO</b>			
<b>1.5</b>		<b>9/94-9/95</b>	<b>4 Cyl 1.5L G15MF</b>
Water Pump	<b>TF3071</b>	<i>Pump without Dust Shield</i>	
Water Pump	<b>TF3074</b>	<i>With Dust Shield</i>	
Timing Belt Kit	<b>TFK009</b>		
Timing Belt Kit with Water Pump	<b>TFK009P</b>	<i>Kit contains TF3071 Pump</i>	
<b>Cielo GL Sohc</b>		<b>9/95-6/98</b>	<b>4 Cyl 1.5L G15MF</b>
Water Pump	<b>TF3071</b>	<i>Pump without Dust Shield</i>	
Water Pump	<b>TF3074</b>	<i>With Dust Shield</i>	
Timing Belt Kit	<b>TFK009</b>		
Timing Belt Kit with Water Pump	<b>TFK009P</b>	<i>Kit contains TF3071 Pump</i>	
<b>Cielo GLX Dohc</b>		<b>9/95-6/98</b>	<b>4 Cyl 1.5L A15MF</b>
Water Pump	<b>TF4045</b>		
Timing Belt Kit	<b>TFK008</b>		



Description	Part No	Year & Notes	Engine
<b>DAEWOO</b>			
<b>Espero CD</b>			
		<b>3/95-8/97</b>	<b>4 Cyl 2.0L C20JE</b>
Water Pump	<b>TF2189</b>	<i>Pump without Dust Shield</i>	
Water Pump	<b>TF2512</b>	<i>With Dust Shield</i>	
Thermostat & Housing	<b>TTH511</b>		
<b>Kalos T200</b>			
		<b>4/03-1/05</b>	<b>4 Cyl 1.5L ETEC II</b>
Water Pump	<b>TF3071</b>	<i>Pump without Dust Shield</i>	
Water Pump	<b>TF3074</b>	<i>With Dust Shield</i>	
Timing Belt Kit	<b>TFK009</b>		
Timing Belt Kit with Water Pump	<b>TFK009P</b>	<i>Kit contains TF3071 Pump</i>	
<b>Korando</b>			
		<b>11/98-7/00</b>	<b>6 Cyl 3.2L 1629930</b>
Water Pump	<b>TF8241</b>		
<b>Lacetti J200</b>			
		<b>9/03-12/04</b>	<b>4 Cyl 1.8L C18SED</b>
Water Pump	<b>TF8112</b>		
Thermostat & Housing	<b>TTH510</b>		
Timing Belt Kit	<b>TFK005</b>		
Timing Belt Kit with Water Pump	<b>TFK005P</b>	<i>Kit contains TF8112 Pump</i>	
<b>Lanos</b>			
		<b>8/97-9/03</b>	<b>4 Cyl 1.5L A15SM</b>
Water Pump	<b>TF3071</b>	<i>Pump without Dust Shield</i>	
Water Pump	<b>TF3074</b>	<i>With Dust Shield</i>	
Timing Belt Kit	<b>TFK009</b>		
Timing Belt Kit with Water Pump	<b>TFK009P</b>	<i>Kit contains TF3071 Pump</i>	
<b>Lanos</b>			
		<b>8/97-4/03</b>	<b>4 Cyl 1.6L A16DMS</b>
Water Pump	<b>TF8273</b>	<i>Pump without Dust Shield</i>	
Water Pump	<b>TF4045</b>	<i>With Dust Shield</i>	
Thermostat & Housing	<b>TTH549</b>	<i>From 9/98</i>	
Timing Belt Kit	<b>TFK008</b>		
Timing Belt Kit with Water Pump	<b>TFK008P</b>	<i>Kit contains TF8273 Pump</i>	
<b>Leganza</b>			
		<b>8/97-4/00</b>	<b>4 Cyl 2.0L C20SED</b>
Water Pump	<b>TF2800</b>		
Thermostat & Housing	<b>TTH510</b>		
Timing Belt Kit	<b>TFK005</b>		
<b>Leganza</b>			
		<b>4/99-1/05</b>	<b>4 Cyl 2.2L T22SED</b>
Water Pump	<b>TF2800</b>		
Thermostat & Housing	<b>TTH510</b>		
Timing Belt Kit	<b>TFK122</b>		

Description	Part No	Year & Notes	Engine
<b>DAEWOO</b>			
<b>Matiz</b>			
		10/99-1/05	3 Cyl 796cc F8CV
Water Pump	TF8113		
Timing Belt Kit	TFK116		
Timing Belt Kit with Water Pump	TFK116P	<i>Kit contains TF8113 Pump</i>	
<b>Musso</b>			
		8/98-4/03	5 Cyl 2.9L M602
Water Pump	TF8499	<i>Pump with Housing</i>	
<b>Musso</b>			
		7/98-12/02	6 Cyl 3.2L IL63200
Water Pump	TF8241		
<b>Nubira SE, SX</b>			
		6/97-10/99	4 Cyl 1.6L A16DMS
Water Pump	TF8273	<i>Pump has Welch Plug</i>	
Timing Belt Kit	TFK008		
Timing Belt Kit with Water Pump	TFK008P	<i>Kit contains TF8273 Pump</i>	
<b>Nubira CDX</b>			
		4/98-12/03	4 Cyl 2.0L C20SED
Water Pump	TF2800		
Thermostat & Housing	TTH510		
<b>Tacuma U100</b>			
		10/00-1/05	4 Cyl 2.0L C20SED, T20SED
Water Pump	TF8112		
Thermostat & Housing	TTH510		
Timing Belt Kit	TFK005		
Timing Belt Kit with Water Pump	TFK005P	<i>Kit contains TF8112 Pump</i>	
<b>DAIHATSU</b>			
<b>Applause A101, A101B</b>			
		10/89-1/00	4 Cyl 1.6L HDE
Water Pump	TF3009		
Timing Belt Kit	TFK072		
<b>Charade G11 incl. Turbo</b>			
		4/83-5/87	3 Cyl 993cc CB20, CB50, CB60
Water Pump	TF2017		
<b>Charade G100 incl. Turbo</b>			
		6/87-1/93	3 Cyl 993cc CB23, CB61
Water Pump	TF2027		
<b>Charade G102</b>			
		6/87-7/93	4 Cyl 1.3L HCE
Water Pump	TF3009		
Timing Belt Kit	TFK073		

Description	Part No	Year & Notes	Engine
<b>DAIHATSU</b>			
<b>Charade G200</b>		<b>10/93-4/96</b>	<b>3 Cyl 993cc CB</b>
Water Pump	<b>TF2027</b>		
<b>Charade G200</b>		<b>6/93-5/98</b>	<b>4 Cyl 1.3L HCE</b>
Water Pump	<b>TF3009</b>		
Timing Belt Kit	<b>TFK073</b>		
<b>Charade G202</b>		<b>8/94-3/98</b>	<b>3 Cyl 993cc CB, CB24</b>
Water Pump	<b>TF2017</b>		
<b>Charade G203</b>		<b>7/94-7/00</b>	<b>4 Cyl 1.5L HEE</b>
Water Pump	<b>TF3009</b>		
Timing Belt Kit	<b>TFK072</b>		
<b>Charade L251S</b>		<b>6/03-on</b>	<b>3 Cyl 989cc EJDE</b>
Water Pump	<b>TF8211</b>	<i>Without Housing</i>	
Water Pump	<b>TF8211H</b>	<i>With Housing</i>	
<b>Charade Centro L500</b>		<b>3/95-6/98</b>	<b>3 Cyl 659cc EFEL</b>
Water Pump	<b>TF3059</b>		
<b>Copen L800 Turbo</b>		<b>10/03-3/07</b>	<b>4 Cyl 659cc JBDET</b>
Water Pump	<b>TF8299</b>		
<b>Cuore L700S</b>		<b>7/00-10/03</b>	<b>3 Cyl 1.0L EJDE</b>
Water Pump	<b>TF8211</b>	<i>Without Housing</i>	
Water Pump	<b>TF8211H</b>	<i>With Housing</i>	
<b>Delta DV23</b>		<b>1971-77</b>	<b>4 Cyl 2.0L 5R</b>
Water Pump	<b>TF858</b>		
<b>Delta DV28</b>		<b>1974-84</b>	<b>4 Cyl 3.0L B</b>
Water Pump	<b>TF885</b>	<i>To 9/80</i>	
Water Pump	<b>TF9075</b>	<i>From 10/80</i>	
<b>Delta SV17</b>		<b>1972-76</b>	<b>4 Cyl 1.6L 12R</b>
Water Pump	<b>TF959</b>		
<b>Delta V10, V11, V12</b>		<b>1974-84</b>	<b>4 Cyl 3.0L B</b>
Water Pump	<b>TF885</b>	<i>To 9/80</i>	
Water Pump	<b>TF9075</b>	<i>From 10/80</i>	
<b>Delta V20, V24</b>		<b>1979-83</b>	<b>4 Cyl 2.5L DG</b>
Water Pump	<b>TF5028</b>		

Description	Part No	Year & Notes	Engine
<b>DAIHATSU</b>			
<b>Delta V30, V31, V32, V34</b>		<b>1979-84</b>	<b>4 Cyl 2.0L 5R</b>
<i>Water Pump</i>	<b>TF847</b>		
<b>Delta V47, V48</b>		<b>1982-84</b>	<b>4 Cyl 3.4L 13B</b>
<i>Water Pump</i>	<b>TF9075</b>		
<b>Delta V50, V54</b>		<b>1983-84</b>	<b>4 Cyl 2.8L DL</b>
<i>Water Pump</i>	<b>TF5028</b>		
<b>Delta V57, V58</b>		<b>11/84-3/03</b>	<b>4 Cyl 2.8L DL</b>
<i>Water Pump</i>	<b>TF3008</b>	<i>To 8/87</i>	
<i>Water Pump</i>	<b>TF3111</b>	<i>From 9/87</i>	
<i>Fan Clutch</i>	<b>TFC130</b>	<i>From 9/87</i>	
<b>Delta V67, V68</b>		<b>1/84-12/88</b>	<b>4 Cyl 2.0L 3Y</b>
<i>Water Pump</i>	<b>TF894</b>		
<i>Fan Clutch</i>	<b>TFC116</b>		
<b>Delta V76, V78, V79</b>		<b>4/84-1/90</b>	<b>4 Cyl 3.4L 13B</b>
<i>Water Pump</i>	<b>TF3038</b>		
<i>Fan Clutch</i>	<b>TFC170</b>		
<b>Delta V90</b>		<b>1981-84</b>	<b>4 Cyl 3.0L B</b>
<i>Water Pump</i>	<b>TF9075</b>		
<b>Delta V98</b>		<b>11/84-12/95</b>	<b>4 Cyl 3.0L B</b>
<i>Water Pump</i>	<b>TF3038</b>		
<b>Delta V99</b>		<b>1/87-3/96</b>	<b>4 Cyl 3.0L B</b>
<i>Water Pump</i>	<b>TF8206</b>	<i>To 4/92</i>	
<i>Water Pump</i>	<b>TF3078</b>	<i>From 4/92</i>	
<i>Fan Clutch</i>	<b>TFC170</b>	<i>All</i>	
<b>Delta V107, V108</b>		<b>10/87-7/98</b>	<b>4 Cyl 2.2L 4Y</b>
<i>Water Pump</i>	<b>TF894</b>		
<i>Fan Clutch</i>	<b>TFC116</b>		
<b>Delta V116, V118, V119</b>		<b>1/89-3/03</b>	<b>4 Cyl 3.7L 14B</b>
<i>Water Pump</i>	<b>TF3078</b>		
<i>Fan Clutch</i>	<b>TFC170</b>		



Description	Part No	Year & Notes	Engine
<b>DAIHATSU</b>			
<b>Delta V138</b>		<b>12/04-3/06</b>	<b>4 Cyl 3.0L 1KDFTV</b>
Water Pump	<b>TF8144</b>	<i>Without Housing</i>	
Water Pump	<b>TF8144H</b>	<i>With Housing</i>	
Timing Belt Kit	<b>TFK221</b>		
Timing Belt Kit	<b>TFK221H</b>	<i>Kit contains Hydraulic Tensioner</i>	
Timing Belt Kit with Water Pump	<b>TFK221P</b>	<i>Kit contains TF8144</i>	
Timing Belt Kit with Water Pump	<b>TFK221PC</b>	<i>Kit contains TF8144H</i>	
<b>F50, F55, F60, F65 Diesel</b>		<b>1979-84</b>	<b>4 Cyl 2.5L, 2.8L DG, DL</b>
Water Pump	<b>TF5028</b>		
<b>Feroza F300, F310</b>		<b>10/88-5/98</b>	<b>4 Cyl 1.6L HDE</b>
Water Pump	<b>TF3122</b>	<i>Pump with Square Hub. If fitted with Round Hub use TF3009</i>	
Fan Clutch	<b>TFC206</b>		
Timing Belt Kit	<b>TFK072</b>		
<b>Handi Van L80V</b>		<b>3/86-12/90</b>	<b>3 Cyl 846cc ED10</b>
Water Pump	<b>TF3059</b>		
<b>Handi Van L701</b>		<b>6/99-4/01</b>	<b>3 Cyl 1.0L EJDE</b>
Water Pump	<b>TF8211</b>	<i>Without Housing</i>	
Water Pump	<b>TF8211H</b>	<i>With Housing</i>	
<b>Hi Jet S70, S75, S76, S85</b>		<b>7/82-12/90</b>	<b>3 Cyl 993cc CB22</b>
Water Pump	<b>TF2017</b>	<i>Pump without Heater Outlet</i>	
<b>Mira L200, L201</b>		<b>11/90-4/95</b>	<b>3 Cyl 660, 847cc EFEL, ED10</b>
Water Pump	<b>TF3059</b>		
<b>Move L601</b>		<b>2/97-1/99</b>	<b>3 Cyl 847cc ED20</b>
Water Pump	<b>TF3059</b>		
<b>Pyzar G301</b>		<b>2/97-8/00</b>	<b>4 Cyl 1.6L HE Eng</b>
Water Pump	<b>TF3009</b>		
Timing Belt Kit	<b>TFK072</b>		
<b>Pyzar G303</b>		<b>2/97-3/99</b>	<b>4 Cyl 1.5L HE-EG</b>
Water Pump	<b>TF3009</b>		
<b>Rocky F70 Diesel</b>		<b>1/84-1/94</b>	<b>4 Cyl 2.8L DL</b>
Water Pump	<b>TF3111</b>		
Fan Clutch	<b>TFC130</b>		

Description	Part No	Year & Notes	Engine
<b>DAIHATSU</b>			
<b>Rocky F70 Turbo Diesel</b>		1/84-1/94	4 Cyl 2.8L DLT
Water Pump	TF3008		
Fan Clutch	TFC130		
<b>Rocky F73 Diesel</b>		8/93-1/99	4 Cyl 2.8L DL52
Water Pump	TF3111		
Fan Clutch	TFC130		
<b>Rocky F75 Diesel</b>		1/85-3/90	4 Cyl 2.8L DL
Water Pump	TF3111		
Fan Clutch	TFC130		
<b>Rocky F75 Turbo Diesel</b>		1989-8/93	4 Cyl 2.8L DLT
Water Pump	TF3008		
Fan Clutch	TFC130		
<b>Rocky F77, F78 incl. Turbo Diesel</b>		1988-1/99	4 Cyl 2.8L DL, DL52
Water Pump	TF3111		
Fan Clutch	TFC130		
<b>Rocky F80, F85, F87 Petrol</b>		6/84-1/89	4 Cyl 2.0L 3YC, 3YE
Water Pump	TF894		
Fan Clutch	TFC116		
<b>Sirion M100</b>		6/98-2/06	3 Cyl 1.0L EJDE
Water Pump	TF8211	<i>Without Housing</i>	
Water Pump	TF8211H	<i>With Housing</i>	
<b>Sirion M101, M300</b>		9/00-3/06	4 Cyl 1.3L K3VE2, KEVE
Water Pump	TF8261	<i>3 Bolt Hole Hub</i>	
<b>SV17</b>		1974-76	4 Cyl 1.6L 12R
Water Pump	TF959		
<b>Terios J100</b>		7/97-10/00	4 Cyl 1.3L HCEJ
Water Pump	TF3122		
Timing Belt Kit	TFK073		
<b>Terios J102</b>		10/00-1/05	4 Cyl 1.3L K3VE
Water Pump	TF8347	<i>4 Hole Mounting</i>	
<b>YRV M201</b>		7/01-12/04	4 Cyl 1.3L K3VE
Water Pump	TF8261		

Description	Part No	Year & Notes	Engine
<b>DODGE</b>			
<b>Nitro</b>		6/07-on	4 Cyl 2.8L 7W
Water Pump	TF8481		
<b>Nitro</b>		6/07-on	V6 3.7L
Water Pump	TF8109		
<b>EUNOS</b>			
<b>30X EC</b>		11/92-5/96	V6 1.8L K8
Water Pump	TF3075	<i>To Chassis No. 0109609 with Round Flat Hub</i>	
Water Pump	TF3076	<i>From Chassis No 019610 with Stepped Star Hub</i>	
<b>500 CA</b>		11/92-12/96	V6 2.0L KF
Water Pump	TF3075	<i>To Chassis No. 0114350 with Round Flat Hub</i>	
Water Pump	TF3076	<i>From Chassis No 0114351 with Stepped Star Hub</i>	
<b>800 TA</b>		3/94-5/96	V6 2.5L KL
Water Pump	TF3076		
<b>FIAT</b>			
<b>500 Petrol</b>		1/08-on	4 Cyl 1.4L
Water Pump	TF8377		
Thermostat & Housing	TTH533		
<b>500 Turbo Diesel</b>		6/08-on	4 Cyl 1.2L
Water Pump	TF8426		
<b>Punto</b>		7/06-on	4 Cyl 1.4L 350A100
Water Pump	TF8377		
Thermostat & Housing	TTH533		
<b>Punto Sport Turbo</b>		1/08-on	4 Cyl 1.4L 199A50
Water Pump	TF8421		
Thermostat & Housing	TTH537		
<b>Punto</b>		7/06-2/09	4 Cyl 1.9L 939A10
Water Pump	TF8146		
Thermostat & Housing	TTH517		

Description	Part No	Year & Notes	Engine
<b>FORD</b>			
<b>Bronco</b>			
		<b>1/81-12/84</b>	<b>6 Cyl 4.1L</b>
Water Pump	<b>TF805</b>	<i>Without Air Conditioning</i>	
Water Pump	<b>TF804</b>	<i>With Air Conditioning</i>	
<b>Bronco</b>			
		<b>9/85-12/87</b>	<b>V8 4.9L</b>
Water Pump	<b>TF2953</b>	<i>With Passenger Side Outlet</i>	
Fan Clutch	<b>TFC101</b>	<i>TFC101 Standard Duty use TFC178 for Heavy Duty Fan Clutch</i>	
Heater Valve / Tap	<b>TFT5217</b>		
<b>Bronco</b>			
		<b>3/81-8/85</b>	<b>V8 5.8L</b>
Water Pump	<b>TF809</b>	<i>Alloy Pump</i>	
Water Pump	<b>TF809C</b>	<i>Cast Iron Pump</i>	
Fan Clutch	<b>TFC101</b>	<i>TFC101 Standard Duty use TFC178 for Heavy Duty Fan Clutch</i>	
Heater Valve / Tap	<b>TFT5217</b>		
<b>Capri</b>			
		<b>5/69-4/73</b>	<b>4 Cyl 1.6L</b>
Water Pump	<b>TF181</b>	<i>To 12/70</i>	
Water Pump	<b>TF730</b>	<i>From 1/71</i>	
<b>Capri SA Sohc</b>			
		<b>10/89-9/90</b>	<b>4 Cyl 1.6L B6</b>
Water Pump	<b>TF1020</b>		
<b>Capri SA Dohc</b>			
		<b>10/89-9/90</b>	<b>4 Cyl 1.6L B6, B6T</b>
Water Pump	<b>TF3010</b>		
Timing Belt Kit	<b>TFK050</b>	<i>145 Teeth x 22mm wide belt</i>	
<b>Capri SB, SC, SE Dohc</b>			
		<b>10/90-7/94</b>	<b>4 Cyl 1.6L B6, B6T</b>
Water Pump	<b>TF3010</b>		
Timing Belt Kit	<b>TFK050</b>	<i>145 Teeth x 22mm wide belt</i>	
<b>Corsair UA</b>			
		<b>11/89-12/92</b>	<b>4 Cyl 2.0L CA20E</b>
Water Pump	<b>TF3023</b>		
Fan Clutch	<b>TFC134</b>		
<b>Corsair UA</b>			
		<b>11/89-12/92</b>	<b>4 Cyl 2.4L KA24E</b>
Water Pump	<b>TF3022</b>		
<b>Cortina 220, 240, 440, GT, Mk1</b>			
		<b>1/63-8/71</b>	<b>4 Cyl 1.2L, 1.3L, 1.5L, 1.6L</b>
Water Pump	<b>TF181</b>		
<b>Cortina TC, TD</b>			
		<b>8/71-5/77</b>	<b>4 Cyl 2.0L</b>
Water Pump	<b>TF746</b>		



Description	Part No	Year & Notes	Engine
<b>FORD</b>			
<b>Cortina TC,TD</b>		<b>8/71-5/77</b>	<b>6 Cyl All</b>
Water Pump	<b>TF800</b>		
<b>Cortina TE</b>		<b>6/77-10/80</b>	<b>4 Cyl 2.0L</b>
Water Pump	<b>TF746</b>		
<b>Cortina TE</b>		<b>6/77-10/80</b>	<b>6 Cyl All</b>
Water Pump	<b>TF800</b>	<i>To 4/80 With Cast Iron Cylinder Head</i>	
Water Pump	<b>TF804</b>	<i>From 4/80 With Alloy Cylinder Head with Air Conditioning</i>	
Water Pump	<b>TF805</b>	<i>From 4/80 With Alloy Cylinder Head without Air Conditioning</i>	
<b>Cortina TF</b>		<b>11/80-8/82</b>	<b>4 Cyl 2.0L</b>
Water Pump	<b>TF746</b>		
<b>Cortina TF</b>		<b>11/80-8/82</b>	<b>6 Cyl All</b>
Water Pump	<b>TF804</b>	<i>Alloy Cylinder Head with Air Conditioning</i>	
<b>Cougar</b>		<b>10/99-2/03</b>	<b>V6 2.5L Duratec</b>
Water Pump	<b>TF8183</b>		
<b>Courier</b>		<b>11/78-2/82</b>	<b>4 Cyl 1.8L VC</b>
Water Pump	<b>TF824</b>		
<b>Courier Ohv Diesel</b>		<b>4/81-5/86</b>	<b>4 Cyl 2.2L S2</b>
Water Pump	<b>TF1028</b>		
<b>Courier PC</b>		<b>11/82-5/86</b>	<b>4 Cyl 2.0L MA</b>
Water Pump	<b>TF756</b>		
<b>Courier PC</b>		<b>6/85-12/92</b>	<b>4 Cyl 2.0L FE</b>
Water Pump	<b>TF893</b>	<i>Suits Round Tooth Timing Belt 22mm Wide</i>	
Water Pump	<b>TF895</b>	<i>Suits Square Tooth Timing Belt 19mm Wide</i>	
Fan Clutch	<b>TFC141</b>	<i>All</i>	
Timing Belt Kit	<b>TFK052</b>	<i>Kit contains Round Tooth Timing Belt</i>	
<b>Courier PC</b>		<b>1/89-6/93</b>	<b>4 Cyl 2.2L F2</b>
Water Pump	<b>TF2032</b>		
Fan Clutch	<b>TFC141</b>		
Timing Belt Kit	<b>TFK051</b>		
<b>Courier PC Ohc Diesel</b>		<b>6/85-4/96</b>	<b>4 Cyl 2.2L R2</b>
Water Pump	<b>TF1018</b>		
Fan Clutch	<b>TFC193</b>		

Description	Part No	Year & Notes	Engine
<b>FORD</b>			
<b>Courier PC</b>		5/87-11/92	4 Cyl 2.6L 4G54
<i>Water Pump</i>	<b>TF1009</b>		
<i>Fan Clutch</i>	<b>TFC117</b>		
<b>Courier PC</b>		10/91-4/96	4 Cyl 2.6L G6
<i>Water Pump</i>	<b>TF3123</b>		
<i>Fan Clutch</i>	<b>TFC114</b>		
<b>Courier PD Diesel</b>		5/96-2/00	4 Cyl 2.5L WL
<i>Water Pump</i>	<b>TF4059</b>		
<i>Fan Clutch</i>	<b>TFC154</b>		
<i>Radiator Fan Blade</i>	<b>TFB529</b>		
<i>Timing Belt Kit</i>	<b>TFK192</b>		
<b>Courier PD</b>		5/96-2/00	4 Cyl 2.6L G6
<i>Water Pump</i>	<b>TF3123</b>		
<i>Fan Clutch</i>	<b>TFC114</b>		
<b>Courier PE incl. Turbo Diesel</b>		2/99-11/02	4 Cyl 2.5L WL, WLT
<i>Water Pump</i>	<b>TF4059</b>		
<i>Fan Clutch</i>	<b>TFC154</b>		
<i>Radiator Fan Blade</i>	<b>TFB546</b>		
<i>Timing Belt Kit</i>	<b>TFK193</b>		
<b>Courier PE</b>		2/99-11/02	4 Cyl 2.6L G6
<i>Water Pump</i>	<b>TF3123</b>		
<i>Fan Clutch</i>	<b>TFC114</b>		
<b>Courier PG incl. Turbo Diesel</b>		11/02-8/04	4 Cyl 2.5L WL, WLT
<i>Water Pump</i>	<b>TF4059</b>		
<i>Fan Clutch</i>	<b>TFC154</b>		
<i>Radiator Fan Blade</i>	<b>TFB546</b>		
<i>Timing Belt Kit</i>	<b>TFK193</b>		
<b>Courier PG</b>		11/02-8/04	4 Cyl 2.6L G6
<i>Water Pump</i>	<b>TF3123</b>		
<i>Fan Clutch</i>	<b>TFC114</b>		
<b>Courier PH incl. Turbo Diesel</b>		8/04-11/06	4 Cyl 2.5L WL, WLAT
<i>Water Pump</i>	<b>TF4059</b>		
<i>Fan Clutch</i>	<b>TFC154</b>		
<i>Radiator Fan Blade</i>	<b>TFB546</b>		
<i>Timing Belt Kit</i>	<b>TFK193</b>		

Description	Part No	Year & Notes	Engine
<b>FORD</b>			
<b>Courier PH</b>		<b>8/04-11/06</b>	<b>4 Cyl 2.6L G6</b>
Water Pump	<b>TF3123</b>		
Fan Clutch	<b>TFC114</b>		
<b>Courier PH</b>		<b>2/05-11/06</b>	<b>V6 4.0L 13V</b>
Water Pump	<b>TF4103</b>		
Fan Clutch	<b>TFC217</b>		
Radiator Fan Blade	<b>TFB540</b>		
<b>Econovan</b>		<b>5/84-12/85</b>	<b>4 Cyl 1.4L UC</b>
Water Pump	<b>TF2051</b>		
<b>Econovan</b>		<b>6/79-4/84</b>	<b>4 Cyl 1.6L NA</b>
Water Pump	<b>TF824</b>		
<b>Econovan</b>		<b>4/84-7/06</b>	<b>4 Cyl 1.8L F8</b>
Water Pump	<b>TF895</b>	<i>To 12/84 Suits Square Tooth Timing Belt 19mm</i>	
Water Pump	<b>TF893</b>	<i>From 12/84 to 4/87 suits Round Tooth Timing Belt 22mm</i>	
Water Pump	<b>TF2032</b>	<i>From 5/87</i>	
Fan Clutch	<b>TFC162</b>	<i>All</i>	
Radiator Fan Blade	<b>TFB538</b>	<i>To 2/98 7 Blade</i>	
<b>Econovan</b>		<b>4/84-7/06</b>	<b>4 Cyl 2.0L FE</b>
Water Pump	<b>TF895</b>	<i>To 12/84 Suits Square Tooth Timing Belt 19mm</i>	
Water Pump	<b>TF893</b>	<i>From 12/84 to 4/87 suits Round Tooth Timing Belt 22mm</i>	
Water Pump	<b>TF2032</b>	<i>From 5/87</i>	
Fan Clutch	<b>TFC162</b>	<i>All</i>	
Radiator Fan Blade	<b>TFB538</b>	<i>To 1/03 7 Blade</i>	
Timing Belt Kit	<b>TFK052</b>	<i>Kit contains Round Tooth Timing Belt</i>	
<b>Econovan</b>		<b>7/81-4/97</b>	<b>4 Cyl 2.2L S2</b>
Water Pump	<b>TF1028</b>		
<b>Econovan</b>		<b>4/84-5/97</b>	<b>4 Cyl 2.2L R2</b>
Water Pump	<b>TF1018</b>		
Fan Clutch	<b>TFC193</b>		
<b>Escape ZB, ZC, ZD</b>		<b>2/04-on</b>	<b>4 Cyl 2.3L L3</b>
Water Pump	<b>TF8265</b>		
Thermostat & Housing	<b>TTH578</b>		

Description	Part No	Year & Notes	Engine
<b>FORD</b>			
<b>Escape BA, ZA, ZB, ZC</b>			
		<b>3/01-4/09</b>	<b>V6 3.0L Duratec</b>
Water Pump	<b>TF8183</b>	<i>To 7/03 Pump without Housing 37mm from bottom face of Pump to end of impeller (Steel)</i>	
Water Pump	<b>TF8183H</b>	<i>To 7/03 Pump with Housing (Outlet 38mm)</i>	
Water Pump	<b>TF8323</b>	<i>From 7/03 Pump without Housing 36mm from bottom face of Pump to end of impeller (Plastic)</i>	
Water Pump	<b>TF8323H</b>	<i>From 7/03 Pump with Housing (Outlet 30mm)</i>	
<b>Escort Mk I, Mk 2</b>			
		<b>1/70-8/82</b>	<b>4 Cyl 1.1L, 1.3L, 1.6L</b>
Water Pump	<b>TF730</b>		
<b>Escort Mk 2</b>			
		<b>7/77-3/81</b>	<b>4 Cyl 2.0L</b>
Water Pump	<b>TF746</b>		
<b>Explorer UN, UP, UQ, US Ohv</b>			
		<b>11/96-10/01</b>	<b>V6 4.0L</b>
Water Pump	<b>TF8185</b>		
<b>Explorer UN, UP, UQ, US Sohc</b>			
		<b>11/96-1/08</b>	<b>V6 4.0L</b>
Water Pump	<b>TF4103</b>		
Fan Clutch	<b>TFC198</b>		
Timing Chain Kit	<b>TCK116G</b>	<i>Suits Manual Transmission Models (kit with Gears)</i>	
Timing Chain Kit	<b>TCK117G</b>	<i>Suits Auto Transmission Models (kit with Gears)</i>	
<b>Explorer UT, UX, UZ Sohc</b>			
		<b>10/01-1/08</b>	<b>V6 4.0L</b>
Water Pump	<b>TF4103</b>		
Fan Clutch	<b>TFC198</b>		
<b>Explorer UT, UX, UZ Sohc</b>			
		<b>10/01-1/08</b>	<b>V8 4.6L</b>
Water Pump	<b>TF8434</b>		
Fan Clutch	<b>TFC198</b>		
<b>F100 RWD</b>			
		<b>1/70-12/85</b>	<b>6 Cyl 4.1L</b>
Water Pump	<b>TF800</b>		
<b>F100 4WD</b>			
		<b>1/80-12/85</b>	<b>6 Cyl 4.1L</b>
Water Pump	<b>TF804</b>	<i>With Air Conditioning</i>	
Water Pump	<b>TF805</b>	<i>Without Air Conditioning</i>	
Fan Clutch	<b>TFC101</b>	<i>Standard Fan Clutch</i>	
Fan Clutch	<b>TFC178</b>	<i>Heavy Duty Fan Clutch</i>	
<b>F100</b>			
		<b>7/74-12/77</b>	<b>V8 4.9L</b>
Water Pump	<b>TF809C</b>	<i>Cast Iron Pump</i>	
Water Pump	<b>TF809</b>	<i>Alloy Pump</i>	
Fan Clutch	<b>TFC101</b>	<i>Standard Fan Clutch</i>	
Fan Clutch	<b>TFC178</b>	<i>Heavy Duty Fan Clutch</i>	

Description	Part No	Year & Notes	Engine
<b>FORD</b>			
<b>F100 RWD</b>			
		<b>9/85-12/87</b>	<b>V8 4.9L Windsor</b>
Water Pump	<b>TF3069</b>	<i>Single Belt Pulley Pump</i>	
Fan Clutch	<b>TFC101</b>	<i>Standard Fan Clutch</i>	
Fan Clutch	<b>TFC178</b>	<i>Heavy Duty Fan Clutch</i>	
<b>F100 4WD</b>			
		<b>9/85-12/87</b>	<b>V8 4.9L Windsor</b>
Water Pump	<b>TF2953</b>	<i>Passenger Side Outlet Pump</i>	
Fan Clutch	<b>TFC101</b>	<i>Standard Fan Clutch</i>	
Fan Clutch	<b>TFC178</b>	<i>Heavy Duty Fan Clutch</i>	
<b>F100</b>			
		<b>1/78-9/85</b>	<b>V8 5.8L Cleveland</b>
Water Pump	<b>TF809C</b>	<i>Cast Iron Pump</i>	
Water Pump	<b>TF809</b>	<i>Alloy Pump</i>	
Fan Clutch	<b>TFC101</b>	<i>Standard Fan Clutch</i>	
Fan Clutch	<b>TFC178</b>	<i>Heavy Duty Fan Clutch</i>	
Heater Valve / Tap	<b>TFT5217</b>		
<b>F150</b>			
		<b>8/87-12/93</b>	<b>V8 4.9L, 5.8L Windsor</b>
Water Pump	<b>TF3069</b>		
Fan Clutch	<b>TFC101</b>	<i>Standard Fan Clutch</i>	
Fan Clutch	<b>TFC178</b>	<i>Heavy Duty Fan Clutch</i>	
Heater Valve / Tap	<b>TFT5217</b>		
<b>F250</b>			
		<b>1/70-12/85</b>	<b>6 Cyl 4.1L</b>
Water Pump	<b>TF805</b>	<i>Without Air Conditioning</i>	
Water Pump	<b>TF804</b>	<i>With Air Conditioning</i>	
<b>F250 Turbo Diesel</b>			
		<b>7/01-4/04</b>	<b>6 Cyl 4.2L</b>
Water Pump	<b>TF8394</b>		
<b>F250</b>			
		<b>9/88-12/89</b>	<b>V8 5.0L Windsor</b>
Water Pump	<b>TF3069</b>		
Fan Clutch	<b>TFC101</b>	<i>Standard Fan Clutch</i>	
Fan Clutch	<b>TFC178</b>	<i>Heavy Duty Fan Clutch</i>	
Heater Valve / Tap	<b>TFT5217</b>		
<b>F250</b>			
		<b>7/01-6/08</b>	<b>V8 5.4L</b>
Water Pump	<b>TF8203</b>		



Description	Part No	Year & Notes	Engine
<b>FORD</b>			
<b>F250</b>			
		<b>1/73-12/85</b>	<b>V8 5.8L Cleveland</b>
Water Pump	<b>TF809C</b>	<i>Cast Iron Pump</i>	
Water Pump	<b>TF809</b>	<i>Alloy Pump</i>	
Fan Clutch	<b>TFC101</b>	<i>Standard Fan Clutch</i>	
Fan Clutch	<b>TFC178</b>	<i>Heavy Duty Fan Clutch</i>	
Heater Valve / Tap	<b>TFT5217</b>		
<b>F250</b>			
		<b>1/90-12/90</b>	<b>V8 5.8L Cleveland</b>
Water Pump	<b>TF3069</b>		
Fan Clutch	<b>TFC101</b>	<i>Standard Fan Clutch</i>	
Fan Clutch	<b>TFC178</b>	<i>Heavy Duty Fan Clutch</i>	
Heater Valve / Tap	<b>TFT5217</b>		
<b>F250 Turbo Diesel</b>			
		<b>7/01-10/06</b>	<b>V8 7.3L</b>
Water Pump	<b>TF8186</b>		
<b>F350 RWD</b>			
		<b>1/70-6/86</b>	<b>6 Cyl 4.1L</b>
Water Pump	<b>TF800</b>		
<b>F350 4WD</b>			
		<b>1/84-12/85</b>	<b>6 Cyl 4.1L</b>
Water Pump	<b>TF805</b>	<i>Without Air Conditioning</i>	
Water Pump	<b>TF804</b>	<i>With Air Conditioning</i>	
<b>F350</b>			
		<b>1/86-12/89</b>	<b>V8 4.9L Windsor</b>
Water Pump	<b>TF809C</b>	<i>Cast Iron Pump</i>	
Water Pump	<b>TF809</b>	<i>Alloy Pump</i>	
Fan Clutch	<b>TFC101</b>	<i>Standard Fan Clutch</i>	
Fan Clutch	<b>TFC178</b>	<i>Heavy Duty Fan Clutch</i>	
Heater Valve / Tap	<b>TFT5217</b>		
<b>F350</b>			
		<b>7/01-9/03</b>	<b>V8 5.4L</b>
Water Pump	<b>TF8203</b>		
<b>F350</b>			
		<b>1/84-12/92</b>	<b>V8 5.8L Windsor</b>
Water Pump	<b>TF809C</b>	<i>Cast Iron Pump</i>	
Water Pump	<b>TF809</b>	<i>Alloy Pump</i>	
Fan Clutch	<b>TFC101</b>	<i>TFC101 Standard Duty use TFC178 for Heavy Duty Fan Clutch</i>	
Heater Valve / Tap	<b>TFT5217</b>		
<b>F350 Turbo Diesel</b>			
		<b>7/01-10/03</b>	<b>V8 7.3L</b>
Water Pump	<b>TF8186</b>		

Description	Part No	Year & Notes	Engine
<b>FORD</b>			
<b>Fairlane AU</b>			
		<b>2/99-12/02</b>	<b>6 Cyl 4.0L</b>
Water Pump	<b>TF3079</b>	<i>Pump without Pulley</i>	
Water Pump	<b>TF3079P</b>	<i>Pump with Pulley</i>	
Heater Valve / Tap	<b>TFT5213</b>		
<b>Fairlane AU</b>			
		<b>3/99-12/02</b>	<b>V8 5.0L Windsor</b>
Water Pump	<b>TF4002</b>		
Heater Valve / Tap	<b>TFT6315</b>		
<b>Fairlane BA</b>			
		<b>7/03-3/06</b>	<b>6 Cyl 4.0L</b>
Water Pump	<b>TF2079</b>	<i>Pump without Pulley</i>	
Water Pump	<b>TF2079P</b>	<i>Pump with Pulley</i>	
Heater Valve / Tap	<b>TFT5213</b>		
<b>Fairlane BF</b>			
		<b>10/05-12/07</b>	<b>6 Cyl 4.0L</b>
Water Pump	<b>TF2079</b>	<i>Pump without Pulley</i>	
Water Pump	<b>TF2079P</b>	<i>Pump with Pulley</i>	
<b>Fairlane BA, BF</b>			
		<b>7/03-on</b>	<b>V8 5.4L</b>
Water Pump	<b>TF8208</b>		
Timing Chain Kit	<b>TCK100G</b>	<i>Suits Boss 260 Dohc (kit with Gears)</i>	
<b>Fairlane NA, NC</b>			
		<b>6/88-3/95</b>	<b>6 Cyl All</b>
Water Pump	<b>TF1040</b>		
Fan Clutch	<b>TFC135</b>	<i>5 Blade Fan</i>	
Fan Clutch	<b>TFC136</b>	<i>10 Blade Fan Type</i>	
Heater Valve / Tap	<b>TFT5213</b>	<i>Suits 4.0L model</i>	
<b>Fairlane NC</b>			
		<b>7/91-3/95</b>	<b>V8 5.0L Windsor</b>
Water Pump	<b>TF3070</b>		
Fan Clutch	<b>TFC122</b>		
Heater Valve / Tap	<b>TFT6315</b>		
<b>Fairlane NF, NL</b>			
		<b>3/95-2/99</b>	<b>6 Cyl 4.0L</b>
Water Pump	<b>TF3079</b>	<i>Pump without Pulley</i>	
Water Pump	<b>TF3079P</b>	<i>Pump with Pulley</i>	
Heater Valve / Tap	<b>TFT5213</b>		
<b>Fairlane NF, NL</b>			
		<b>3/95-2/99</b>	<b>V8 5.0L Windsor</b>
Water Pump	<b>TF3070</b>		
Fan Clutch	<b>TFC122</b>		
Heater Valve / Tap	<b>TFT6315</b>		

Description	Part No	Year & Notes	Engine
<b>FORD</b>			
<b>Fairlane ZA, ZB, ZC</b>		<b>3/67-10/70</b>	<b>6 Cyl 200, 221ci</b>
Water Pump	<b>TF564</b>		
<b>Fairlane ZA, ZB, ZC</b>		<b>3/67-10/70</b>	<b>V8 All Windsor</b>
Water Pump	<b>TF807</b>	<i>Check Pump type with Driver Side Outlet</i>	
Water Pump	<b>TF2953</b>	<i>Check Pump type with Passenger Side Outlet</i>	
<b>Fairlane ZD, ZF, ZG</b>		<b>11/70-5/76</b>	<b>6 Cyl 250ci</b>
Water Pump	<b>TF800</b>	<i>Without Air Conditioning</i>	
Water Pump	<b>TF805</b>	<i>With Air Conditioning</i>	
<b>Fairlane ZD, ZF, ZG, ZH</b>		<b>11/70-4/80</b>	<b>V8 302, 351ci Cleveland</b>
Water Pump	<b>TF809</b>		
Fan Clutch	<b>TFC101</b>		
<b>Fairlane ZJ</b>		<b>10/79-3/83</b>	<b>6 Cyl 4.1L</b>
Water Pump	<b>TF804</b>	<i>Cross Flow Cylinder Head with Air Conditioning</i>	
Water Pump	<b>TF805</b>	<i>Cross Flow Cylinder Head without Air Conditioning</i>	
Heater Valve / Tap	<b>TFT5217</b>		
<b>Fairlane ZJ</b>		<b>5/79-3/83</b>	<b>V8 4.9L, 5.8L Cleveland</b>
Water Pump	<b>TF809</b>		
Fan Clutch	<b>TFC101</b>		
Heater Valve / Tap	<b>TFT5217</b>		
<b>Fairlane ZK, ZL</b>		<b>3/82-6/89</b>	<b>6 Cyl 4.1L</b>
Water Pump	<b>TF804</b>		
Heater Valve / Tap	<b>TFT5217</b>		
<b>Fairlane ZK</b>		<b>3/82-10/84</b>	<b>V8 4.9L Cleveland</b>
Water Pump	<b>TF809</b>		
Fan Clutch	<b>TFC101</b>		
Heater Valve / Tap	<b>TFT5217</b>		
<b>Falcon AU</b>		<b>8/98-9/02</b>	<b>6 Cyl 4.0L</b>
Water Pump	<b>TF3079</b>	<i>Pump without Pulley</i>	
Water Pump	<b>TF3079P</b>	<i>Pump with Pulley</i>	
Heater Valve / Tap	<b>TFT5213</b>		
<b>Falcon AU</b>		<b>8/98-9/02</b>	<b>V8 5.0L Windsor</b>
Water Pump	<b>TF4002</b>		
Heater Valve / Tap	<b>TFT6315</b>		

Description	Part No	Year & Notes	Engine
<b>FORD</b>			
<b>Falcon BA</b>			
		<b>9/02-10/05</b>	<b>6 Cyl 4.0L</b>
Water Pump	<b>TF3079</b>	<i>To 11/03 Pump without Pulley</i>	
Water Pump	<b>TF3079P</b>	<i>To 11/03 Pump with Pulley</i>	
Water Pump	<b>TF2079</b>	<i>From 11/03 Pump without Pulley</i>	
Water Pump	<b>TF2079P</b>	<i>From 11/03 Pump with Pulley</i>	
Heater Valve / Tap	<b>TFT5213</b>		
<b>Falcon BF</b>			
		<b>10/05-4/08</b>	<b>6 Cyl 4.0L</b>
Water Pump	<b>TF2079</b>	<i>Pump without Pulley</i>	
Water Pump	<b>TF2079P</b>	<i>Pump with Pulley</i>	
<b>Falcon BA, BF</b>			
		<b>09/02-on</b>	<b>V8 5.4L</b>
Water Pump	<b>TF8208</b>	<i>Suits all</i>	
Timing Chain Kit	<b>TCK100G</b>	<i>Suits Boss 260 Dohc (kit with Gears)</i>	
<b>Falcon EA, EB, ED</b>			
		<b>2/88-8/94</b>	<b>6 Cyl All</b>
Water Pump	<b>TF1040</b>		
Fan Clutch	<b>TFC135</b>	<i>5 Blade Fan</i>	
Fan Clutch	<b>TFC136</b>	<i>10 Blade Fan Type</i>	
Heater Valve / Tap	<b>TFT5213</b>		
<b>Falcon EB, ED</b>			
		<b>7/91-8/94</b>	<b>V8 5.0L Windsor</b>
Water Pump	<b>TF3070</b>		
Fan Clutch	<b>TFC122</b>		
Heater Valve / Tap	<b>TFT6315</b>		
<b>Falcon EF, EL</b>			
		<b>8/94-8/98</b>	<b>6 Cyl 4.0L</b>
Water Pump	<b>TF3079</b>	<i>Pump without Pulley</i>	
Water Pump	<b>TF3079P</b>	<i>Pump with Pulley</i>	
Heater Valve / Tap	<b>TFT5213</b>		
<b>Falcon EF, EL</b>			
		<b>8/94-8/98</b>	<b>V8 5.0L Windsor</b>
Water Pump	<b>TF3070</b>		
Fan Clutch	<b>TFC122</b>		
Heater Valve / Tap	<b>TFT6315</b>		
<b>Falcon FG</b>			
		<b>4/08-on</b>	<b>6 Cyl 4.0L</b>
Water Pump	<b>TF2079</b>	<i>Pump without Pulley</i>	
Water Pump	<b>TF2079P</b>	<i>Pump with Pulley</i>	
<b>Falcon FG</b>			
		<b>4/08-on</b>	<b>V8 5.4L</b>
Water Pump	<b>TF8208</b>		
Timing Chain Kit	<b>TCK100G</b>	<i>Kit with Gears</i>	

Description	Part No	Year & Notes	Engine
<b>FORD</b>			
<b>Falcon XA, XB</b>			
		<b>3/72-9/76</b>	<b>6 Cyl All</b>
Water Pump	<b>TF800</b>	<i>Without Air Conditioning</i>	
Water Pump	<b>TF805</b>	<i>With Air Conditioning</i>	
Heater Valve / Tap	<b>TFT5202</b>		
<b>Falcon XA, XB</b>			
		<b>3/72-7/76</b>	<b>V8 302, 351ci Cleveland</b>
Water Pump	<b>TF809</b>		
Fan Clutch	<b>TFC101</b>		
Heater Valve / Tap	<b>TFT5202</b>		
<b>Falcon XC</b>			
		<b>8/76-1/78</b>	<b>6 Cyl All</b>
Water Pump	<b>TF804</b>	<i>With Air Conditioning</i>	
Water Pump	<b>TF805</b>	<i>Without Air Conditioning</i>	
Heater Valve / Tap	<b>TFT5217</b>		
<b>Falcon XC</b>			
		<b>8/76-1/78</b>	<b>V8 4.9L, 5.8L Cleveland</b>
Water Pump	<b>TF809</b>		
Fan Clutch	<b>TFC101</b>		
Heater Valve / Tap	<b>TFT5217</b>		
<b>Falcon XD</b>			
		<b>1/80-3/83</b>	<b>6 Cyl All</b>
Water Pump	<b>TF804</b>	<i>With Air Conditioning</i>	
Water Pump	<b>TF805</b>	<i>Without Air Conditioning</i>	
Heater Valve / Tap	<b>TFT5217</b>		
<b>Falcon XD</b>			
		<b>1/79-2/82</b>	<b>V8 4.9L, 5.8L Cleveland</b>
Water Pump	<b>TF809</b>		
Fan Clutch	<b>TFC101</b>		
Heater Valve / Tap	<b>TFT5217</b>		
<b>Falcon XE, XF</b>			
		<b>4/82-1/91</b>	<b>6 Cyl All</b>
Water Pump	<b>TF804</b>		
Heater Valve / Tap	<b>TFT5217</b>		
<b>Falcon XE, XF</b>			
		<b>4/82-10/83</b>	<b>V8 4.9L, 5.8L Cleveland</b>
Water Pump	<b>TF809</b>		
Fan Clutch	<b>TFC101</b>		
Heater Valve / Tap	<b>TFT5217</b>		
<b>Falcon XG Ute, Van</b>			
		<b>3/93-3/96</b>	<b>6 Cyl 4.0L</b>
Water Pump	<b>TF1040</b>		
Fan Clutch	<b>TFC136</b>	<i>10 Blade Fan Type</i>	
Fan Clutch	<b>TFC135</b>	<i>5 Blade Fan</i>	
Heater Valve / Tap	<b>TFT5213</b>		



Description	Part No	Year & Notes	Engine
<b>FORD</b>			
<b>Falcon XH Ute, Van</b>		<b>3/96-5/99</b>	<b>6 Cyl 4.0L</b>
Water Pump	<b>TF3079</b>	<i>Pump without Pulley</i>	
Water Pump	<b>TF3079P</b>	<i>Pump with Pulley</i>	
Heater Valve / Tap	<b>TFT5213</b>		
<b>Falcon XH Ute</b>		<b>10/97-5/99</b>	<b>V8 5.0L</b>
Water Pump	<b>TF3070</b>		
Fan Clutch	<b>TFC122</b>		
<b>Falcon XM, XP, XR, XT, XW</b>		<b>1/64-11/70</b>	<b>6 Cyl All</b>
Water Pump	<b>TF564</b>		
<b>Falcon XR, XT, XW</b>		<b>9/66-7/71</b>	<b>V8 All Windsor</b>
Water Pump	<b>TF807</b>	<i>With Driver Side Outlet</i>	
Water Pump	<b>TF2953</b>	<i>With Passenger Side Outlet</i>	
<b>Falcon XY</b>		<b>11/70-3/72</b>	<b>6 Cyl 250ci</b>
Water Pump	<b>TF800</b>		
<b>Falcon XY</b>		<b>11/70-3/72</b>	<b>V8 302, 351ci Cleveland</b>
Water Pump	<b>TF809</b>		
Fan Clutch	<b>TFC101</b>		
<b>Festiva WA, WD, WF</b>		<b>10/91-12/00</b>	<b>4 Cyl 1.3L, 1.5L B3, B5</b>
Water Pump	<b>TF1020</b>		
Timing Belt Kit	<b>TFK049</b>		
Timing Belt Kit with Water Pump	<b>TFK049P</b>	<i>Kit contains TF1020 Pump</i>	
<b>Fiesta WP, WQ</b>		<b>4/04-3/09</b>	<b>4 Cyl 1.6L Q100PS</b>
Water Pump	<b>TF8277</b>	<i>To 4/05</i>	
Water Pump	<b>TF8375</b>	<i>From 4/05</i>	
<b>Fiesta XR4 WQ</b>		<b>6/07-3/09</b>	<b>4 Cyl 2.0L Duratec</b>
Water Pump	<b>TF8342</b>		
<b>Fiesta WS</b>		<b>2/09-on</b>	<b>4 Cyl 1.4L</b>
Water Pump	<b>TF8375</b>		
<b>Fiesta WS</b>		<b>2/09-on</b>	<b>4 Cyl 1.6L Duratec</b>
Water Pump	<b>TF8375</b>		
<b>Focus LR</b>		<b>9/02-5/05</b>	<b>4 Cyl 1.8L, 2.0L EYED, 2U</b>
Water Pump	<b>TF8181</b>		

Description	Part No	Year & Notes	Engine
<b>FORD</b>			
<b>Focus LS</b>		5/05-8/08	4 Cyl 2.0L Duratec
Water Pump	TF8342		
<b>Focus LS</b>		5/06-7/07	5 Cyl 2.5L B5254T3
Water Pump	TF8353		
<b>Focus LT</b>		7/07-5/10	4 Cyl 2.0L Duratec
Water Pump	TF8342		
<b>Focus LT</b>		7/07-3/09	5 Cyl 2.5L B5254T3
Water Pump	TF8353		
<b>Focus LT Turbo Diesel</b>		7/07-5/10	4 Cyl 2.0L D4204T
Water Pump	TF8382		
Thermostat & Housing	TTH543		
<b>Focus LV Turbo Diesel</b>		1/08-on	4 Cyl 2.0L D4204T
Water Pump	TF8382	To 8/10	
Thermostat & Housing	TTH543		
<b>Focus LV</b>		1/08-on	5 Cyl 2.5L B5254T3
Water Pump	TF8353		
<b>Laser KA, KB</b>		3/81-12/85	4 Cyl 1.3L, 1.5L E3, E5
Water Pump	TF817		
<b>Laser KC, KE</b>		10/85-12/90	4 Cyl 1.3L E3
Water Pump	TF817		
<b>Laser KC, KE, KF, KH Non Turbo</b>		10/85-10/94	4 Cyl 1.6L B6, BP
Water Pump	TF1020		
Timing Belt Kit	TFK048	Kit contains 21mm Wide Timing Belt	
Timing Belt Kit	TFK049	Kit contains 22mm Wide Timing Belt	
Timing Belt Kit with Water Pump	TFK049P	Kit contains TF1020 Pump & 22mm Wide Timing Belt	
Timing Belt Kit with Water Pump	TFK048P	Kit contains TF1020 Pump & 21mm Wide Timing Belt	
<b>Laser KC, KE, KF, KH Turbo</b>		10/85-10/94	4 Cyl 1.6L B6T, BPD
Water Pump	TF3010		
Timing Belt Kit	TFK050		

Description	Part No	Year & Notes	Engine
<b>FORD</b>			
<b>Laser KJ</b>			
		10/94-3/99	4 Cyl 1.6L, 1.8L B6, BP, BPE
Water Pump	TF3081		
Timing Belt Kit	TFK050	<i>Kit contains 145 Teeth x 22mm Wide Timing Belt</i>	
Timing Belt Kit	TFK155	<i>Kit contains 133 Teeth x 25mm Wide Timing Belt</i>	
Timing Belt Kit with Water Pump	TFK050P	<i>Kit contains 145 Teeth x 22mm Wide Timing Belt &amp; TF3081 Pump</i>	
<b>Laser KN, KQ</b>			
		2/99-10/02	4 Cyl 1.6L ZM
Water Pump	TF3081		
Timing Belt Kit	TFK112		
Timing Belt Kit with Water Pump	TFK112P	<i>Kit contains TF3081 Pump</i>	
<b>Laser KN, KQ</b>			
		2/99-10/02	4 Cyl 1.8L FP
Water Pump	TF3082	<i>Pump without Housing</i>	
Timing Belt Kit	TFK155		
Timing Belt Kit with Water Pump	TFK155P	<i>Kit contains TF3082 Pump</i>	
<b>Laser KQ</b>			
		4/01-10/02	4 Cyl 2.0L FS
Water Pump	TF3082	<i>Pump without Housing</i>	
Timing Belt Kit	TFK045		
Timing Belt Kit with Water Pump	TFK045P	<i>Kit contains TF3082 Pump</i>	
<b>LTD AU</b>			
		6/99-12/02	6 Cyl 4.0L
Water Pump	TF3079	<i>Pump without Pulley</i>	
Water Pump	TF3079P	<i>Pump with Pulley</i>	
Heater Valve / Tap	TFT5213		
<b>LTD AU</b>			
		6/99-12/02	V8 5.0L Windsor
Water Pump	TF4002		
Heater Valve / Tap	TFT6315		
<b>LTD BA, BF</b>			
		7/03-3/08	V8 5.4L
Water Pump	TF8208		
<b>LTD</b>			
		1973-79	V8 351ci Cleveland
Water Pump	TF809		
<b>LTD DA, DC</b>			
		6/88-3/95	6 Cyl 3.9L
Water Pump	TF1040		
Fan Clutch	TFC136	<i>10 Blade Fan Type</i>	
Fan Clutch	TFC135	<i>5 Blade Fan</i>	
Heater Valve / Tap	TFT5213		

Description	Part No	Year & Notes	Engine
<b>FORD</b>			
<b>LTD DC</b>			
		7/91-3/95	V8 5.0L
Water Pump	TF3070		
Fan Clutch	TFC122		
Heater Valve / Tap	TFT6315		
<b>LTD DF, DL</b>			
		3/95-6/99	6 Cyl 4.0L
Water Pump	TF3079	<i>Pump without Pulley</i>	
Water Pump	TF3079P	<i>Pump with Pulley</i>	
Heater Valve / Tap	TFT5213	<i>To 7/98</i>	
<b>LTD DF, DL</b>			
		3/95-6/99	V8 5.0L
Water Pump	TF3070		
Fan Clutch	TFC122		
Heater Valve / Tap	TFT6315	<i>To 7/98</i>	
<b>LTD FC</b>			
		10/79-2/82	6 Cyl 4.1L
Water Pump	TF805		
Heater Valve / Tap	TFT5217		
<b>LTD FC</b>			
		6/79-2/82	V8 5.8L
Water Pump	TF809		
Fan Clutch	TFC101		
Heater Valve / Tap	TFT5217		
<b>LTD FD, FE</b>			
		3/82-5/88	6 Cyl 4.1L
Water Pump	TF804		
Heater Valve / Tap	TFT5217		
<b>LTD FD</b>			
		3/82-2/83	V8 4.9L, 5.8L
Water Pump	TF809		
Fan Clutch	TFC101		
Heater Valve / Tap	TFT5217		
<b>Maverick Petrol</b>			
		2/88-9/93	6 Cyl 4.2L TB42
Water Pump	TF5010		
Fan Clutch	TFC138		
<b>Maverick Diesel</b>			
		2/88-9/93	6 Cyl 4.2L TD42
Water Pump	TF6056		
Fan Clutch	TFC110	<i>With Manual Transmission</i>	
Fan Clutch	TFC111	<i>With Automatic Transmission</i>	
<b>Meteor GA, GB</b>			
		4/82-9/85	4 Cyl 1.5L E5
Water Pump	TF817		

Description	Part No	Year & Notes	Engine
<b>FORD</b>			
<b>Meteor GC</b>		<b>10/85-9/87</b>	<b>4 Cyl 1.6L B6 B6T</b>
Water Pump	<b>TF1020</b>	<i>Non Turbo Model</i>	
Water Pump	<b>TF3010</b>	<i>Turbo Model</i>	
Timing Belt Kit	<b>TFK048</b>	<i>Kit contains 107 Teeth x 21mm Wide Timing Belt</i>	
<b>Mondeo HA, HB, HC, HD, HE</b>		<b>7/95-4/01</b>	<b>4 Cyl 2.0L Zetec</b>
Water Pump	<b>TF2990</b>		
<b>Mondeo HE</b>		<b>3/00-4/01</b>	<b>V6 2.5L</b>
Water Pump	<b>TF8183</b>		
<b>Mondeo MA Diesel</b>		<b>10/07-on</b>	<b>4 Cyl 2.0L Duratorq</b>
Water Pump	<b>TF8382</b>	<i>To 8/10</i>	
<b>Mondeo MA</b>		<b>10/07-on</b>	<b>4 Cyl 2.3L Duratec</b>
Water Pump	<b>TF8342</b>		
<b>Mondeo MB</b>		<b>6/10-on</b>	<b>4 Cyl 2.0L Duratorq</b>
Water Pump	<b>TF8477</b>		
<b>Probe ST</b>		<b>7/94-3/96</b>	<b>V6 2.5L KL</b>
Water Pump	<b>TF3075</b>	<i>Pump has Round Flat Hub</i>	
Timing Belt Kit	<b>TFK041</b>		
<b>Probe SU, SV</b>		<b>3/96-1/98</b>	<b>V6 2.5L KL</b>
Water Pump	<b>TF3076</b>	<i>Pump has Stepped Star Hub</i>	
Timing Belt Kit	<b>TFK041</b>		
<b>Raider UV</b>		<b>8/91-11/96</b>	<b>4 Cyl 2.6L G6</b>
Water Pump	<b>TF3123</b>		
Fan Clutch	<b>TFC114</b>		
<b>Ranger PJ, PK Turbo Diesel</b>		<b>1/07-on</b>	<b>4 Cyl 2.5L, 3.0L WLAT, WEAT</b>
Water Pump	<b>TF4059</b>		
Fan Clutch	<b>TFC234</b>		
Radiator Fan Blade	<b>TFB529</b>		
<b>Spectron</b>		<b>1/83-5/84</b>	<b>4 Cyl 1.6L NA</b>
Water Pump	<b>TF824</b>		
<b>Spectron</b>		<b>5/84-12/86</b>	<b>4 Cyl 1.8L F8</b>
Water Pump	<b>TF895</b>	<i>Suits Square Tooth Timing Belt 19mm Wide</i>	
Water Pump	<b>TF893</b>	<i>Suits Round Tooth Timing Belt 22mm Wide</i>	
Fan Clutch	<b>TFC162</b>	<i>All</i>	



Description	Part No	Year & Notes	Engine
<b>FORD</b>			
<b>Spectron</b>			
		<b>3/86-3/89</b>	<b>4 Cyl 2.0L FE</b>
Water Pump	<b>TF893</b>	To 2/87 With Round Tooth Timing Belt 22mm	
Water Pump	<b>TF895</b>	To 2/87 With Square Tooth Timing Belt 19mm	
Water Pump	<b>TF2032</b>	From 2/87	
Fan Clutch	<b>TFC162</b>	All	
Timing Belt Kit	<b>TFK052</b>	Kit contains Round Tooth Timing Belt	
<b>Taurus DN, DP</b>			
		<b>3/96-9/98</b>	<b>V6 3.0L Duratec</b>
Water Pump	<b>TF8184</b>		
<b>Telstar AR, AS Incl. TX5</b>			
		<b>5/83-9/87</b>	<b>4 Cyl 2.0L FE</b>
Water Pump	<b>TF893</b>	Suits Round Tooth Timing Belt 22mm Wide	
Water Pump	<b>TF895</b>	Suits Square Tooth Timing Belt 19mm Wide	
<b>Telstar AT, AV Incl. TX5</b>			
		<b>10/87-1/92</b>	<b>4 Cyl 2.0L FE</b>
Water Pump	<b>TF2032</b>		
Timing Belt Kit	<b>TFK052</b>		
<b>Telstar AT, AV Incl. TX5</b>			
		<b>10/87-1/92</b>	<b>4 Cyl 2.2L F2</b>
Water Pump	<b>TF2032</b>		
Timing Belt Kit	<b>TFK051</b>		
<b>Telstar AX, AY Incl. TX5</b>			
		<b>1/92-11/96</b>	<b>4 Cyl 2.0L FS</b>
Water Pump	<b>TF3082</b>	Pump without Housing	
Timing Belt Kit	<b>TFK045</b>		
Timing Belt Kit with Water Pump	<b>TFK045P</b>	Kit contains TF3082 Pump	
<b>Telstar AX, AY Incl. TX5</b>			
		<b>1/92-11/96</b>	<b>V6 2.5L KL</b>
Water Pump	<b>TF3075</b>	To 6/93	
Water Pump	<b>TF3076</b>	From 7/93	
Timing Belt Kit	<b>TFK041</b>		
<b>Territory SX, SY incl. Turbo</b>			
		<b>5/04-on</b>	<b>6 Cyl 4.0L</b>
Water Pump	<b>TF2079</b>	Pump without Pulley	
Water Pump	<b>TF2079P</b>	Pump with Pulley	
<b>Trader 0409, 0509, 0812 incl. Turbo</b>			
		<b>3/84-9/95</b>	<b>4 Cyl 3.5L SL, SLT</b>
Water Pump	<b>TF3013</b>		
Fan Clutch	<b>TFC158</b>		
<b>Trader 0409, 0509, 0811</b>			
		<b>10/95-4/99</b>	<b>4 Cyl 4.0L TF</b>
Water Pump	<b>TF8179</b>		
Fan Clutch	<b>TFC163</b>		

Description	Part No	Year & Notes	Engine
<b>FORD</b>			
<b>Trader 0811</b>		1/83-10/89	6 Cyl 4.1L ZB
Water Pump	TF3014		
Fan Clutch	TFC159		
<b>Trader 0811</b>		10/95-4/99	4 Cyl 4.6L TM
Water Pump	TF8179		
Fan Clutch	TFC163		
<b>Transit Van</b>		5/73-12/83	6 Cyl 4.1L
Water Pump	TF805		
<b>Transit VE Diesel</b>		6/94-5/96	4 Cyl 2.5L 4GB
Water Pump	TF2565		
<b>Transit VF, VG Petrol</b>		1/96-11/00	4 Cyl 2.0L N9K
Water Pump	TF4498		
<b>Transit VF, VG Turbo Diesel</b>		1/96-11/00	4 Cyl 2.5L 85PS
Water Pump	TF2565		
<b>Transit VH, VJ Petrol</b>		12/00-9/06	4 Cyl 2.3L
Water Pump	TF4498	To 1/04	
Water Pump	TF8409	From 1/04	
<b>Transit VH, VJ Turbo Diesel</b>		12/00-9/06	4 Cyl 2.4L
Water Pump	TF8264	Without Housing	
Water Pump	TF8264H	With Housing	
<b>Transit VM Turbo Diesel</b>		3/06-on	4 Cyl 2.2L QFA
Water Pump	TF8386		
<b>Transit VM Petrol</b>		3/06-on	4 Cyl 2.3L Duratec
Water Pump	TF8265		
<b>Transit VM Turbo Diesel</b>		3/06-on	4 Cyl 2.4L 6T
Water Pump	TF8264	Without Housing	
Water Pump	TF8264H	With Housing	

Description	Part No	Year & Notes	Engine
<b>GREAT WALL</b>			
<b>V200 K2 Turbo Diesel</b>		<b>08/11-on</b>	<b>4 Cyl 2.0L GW4D20</b>
<i>Water Pump</i>	<b>TF8465</b>		
<b>V240</b>		<b>06/09-on</b>	<b>4 Cyl 2.4L 4G69</b>
<i>Water Pump</i>	<b>TF8466</b>		
<b>HOLDEN</b>			
<b>Adventra VZ</b>		<b>3/05-1/09</b>	<b>V6 3.6L</b>
<i>Water Pump</i>	<b>TF5000</b>		
<i>Thermostat &amp; Housing</i>	<b>TTH548</b>		
<b>Adventra VY, VZ</b>		<b>10/03-1/06</b>	<b>V8 5.7L Gen 3</b>
<i>Water Pump</i>	<b>TF4013</b>	<i>Pump without Thermostat Housing</i>	
<b>Apollo JK, JL</b>		<b>8/89-2/93</b>	<b>4 Cyl 2.0L 3SFC, 3SFE</b>
<i>Water Pump</i>	<b>TF3047</b>	<i>Pump without Housing</i>	
<i>Water Pump</i>	<b>TF3047H</b>	<i>Pump with Housing</i>	
<i>Timing Belt Kit</i>	<b>TFK013</b>		
<i>Timing Belt Kit with Water Pump</i>	<b>TFK013P</b>	<i>Kit contains TF3047 Pump without Housing</i>	
<i>Timing Belt Kit with Water Pump</i>	<b>TFK013PC</b>	<i>Kit contains TF3047H Pump with Housing</i>	
<b>Apollo JM, JP</b>		<b>3/93-5/97</b>	<b>4 Cyl 2.2L 5SFE</b>
<i>Water Pump</i>	<b>TF3047</b>	<i>Pump without Housing</i>	
<i>Water Pump</i>	<b>TF3047H</b>	<i>Pump with Housing</i>	
<i>Timing Belt Kit</i>	<b>TFK013</b>		
<i>Timing Belt Kit with Water Pump</i>	<b>TFK013P</b>	<i>Kit contains TF3047 Pump without Housing</i>	
<i>Timing Belt Kit with Water Pump</i>	<b>TFK013PC</b>	<i>Kit contains TF3047H Pump with Housing</i>	
<b>Apollo JM, JP</b>		<b>3/93-5/97</b>	<b>V6 3.0L 3VZFE</b>
<i>Water Pump</i>	<b>TF3040</b>		
<i>Timing Belt Kit</i>	<b>TFK011</b>		
<b>Astra LB, LC</b>		<b>8/84-5/88</b>	<b>4 Cyl 1.5L, 1.6L E15, E16</b>
<i>Water Pump</i>	<b>TF888</b>		
<b>Astra LD</b>		<b>7/87-1/90</b>	<b>4 Cyl 1.6L, 1.8L 16LF, 18LE</b>
<i>Water Pump</i>	<b>TF2189</b>		
<i>Thermostat &amp; Housing</i>	<b>TTH502</b>		

Description	Part No	Year & Notes	Engine
<b>HOLDEN</b>			
<b>Astra AH</b>			
		<b>9/04-on</b>	<b>4 Cyl 1.8L Z18XE, Z18XER</b>
Water Pump	<b>TF4042</b>	<i>To 2/07 Z18XE Engine</i>	
Water Pump	<b>TF8391</b>	<i>From 2/07 Z18XER Engine</i>	
Thermostat & Housing	<b>TTH509</b>	<i>To 2/07 Z18XE Engine</i>	
Thermostat & Housing	<b>TTH546</b>	<i>From 2/07 Z18XER Engine</i>	
Timing Belt Kit with Water Pump	<b>TFK4042</b>	<i>Kit contains TF4042 Pump</i>	
<b>Astra AH</b>			
		<b>5/06-12/09</b>	<b>4 Cyl 1.9L Z19DT4</b>
Water Pump	<b>TF8146</b>		
Thermostat & Housing	<b>TTH517</b>		
<b>Astra AH Sohc</b>			
		<b>5/06-12/09</b>	<b>4 Cyl 1.9L Z19DTH4</b>
Water Pump	<b>TF8172</b>		
Thermostat & Housing	<b>TTH517</b>		
<b>Astra AH Dohc</b>			
		<b>5/06-on</b>	<b>4 Cyl 2.0L Z20LER</b>
Water Pump	<b>TF8112</b>		
Thermostat & Housing	<b>TTH507</b>		
<b>Astra AH</b>			
		<b>12/06-6/09</b>	<b>4 Cyl 2.2L Z22SE</b>
Water Pump	<b>TF8259</b>		
Timing Chain Kit	<b>TCK101G</b>	<i>Camshaft kit (kit with Gears)</i>	
Timing Chain Kit	<b>TCK102G</b>	<i>Balance Shaft kit (kit with Gears)</i>	
<b>Astra TR</b>			
		<b>9/95-9/98</b>	<b>4 Cyl 1.6L C16SE</b>
Water Pump	<b>TF3074</b>		
Heater Valve / Tap	<b>TFT2007</b>		
Timing Belt Kit	<b>TFK009</b>		
<b>Astra TR</b>			
		<b>8/96-9/98</b>	<b>4 Cyl 1.8L C18SE</b>
Water Pump	<b>TF8112</b>		
Thermostat & Housing	<b>TTH525</b>		
Heater Valve / Tap	<b>TFT2007</b>		
Timing Belt Kit	<b>TFK005</b>		
Timing Belt Kit with Water Pump	<b>TFK005P</b>	<i>Kit contains TF8112 Pump</i>	
<b>Astra TR</b>			
		<b>8/96-9/98</b>	<b>4 Cyl 2.0L X20XEV</b>
Water Pump	<b>TF8112</b>		
Heater Valve / Tap	<b>TFT2007</b>		
Thermostat & Housing	<b>TTH507</b>		

Description	Part No	Year & Notes	Engine
<b>HOLDEN</b>			
<b>Astra TS</b>			
		9/98-4/06	4 Cyl 1.8L Z18XE, X18XE
Water Pump	TF4042		
Thermostat & Housing	TTH509		
Timing Belt Kit	TFK006	<i>Kit contains small Plastic idler</i>	
Timing Belt Kit	TFK093	<i>Kit contains small Metal idler</i>	
Timing Belt Kit with Water Pump	TFK4042	<i>Kit contains small Plastic idler &amp; TF4042 Pump</i>	
Timing Belt Kit with Water Pump	TFK093P	<i>Kit contains small Metal idler &amp; TF4042 Pump</i>	
<b>Astra TS</b>			
		4/03-6/04	4 Cyl 2.0L Z20LET
Water Pump	TF8112		
Thermostat & Housing	TTH507		
<b>Astra TS</b>			
		10/01-1/07	4 Cyl 2.2L Z22SE
Water Pump	TF8259		
<b>Barina MB</b>			
		2/85-8/86	4 Cyl 1.3L G13A
Water Pump	TF3037	<i>With Automatic Transmission</i>	
Water Pump	TF2008	<i>With Manual Transmission</i>	
Timing Belt Kit	TFK067		
<b>Barina MF, MH</b>			
		2/89-5/94	4 Cyl 1.3L G13B
Water Pump	TF3037	<i>Pump has Timing Cover Bolt hole</i>	
Timing Belt Kit	TFK067		
<b>Barina ML</b>			
		9/86-1/89	4 Cyl 1.3L G13A
Water Pump	TF3037	<i>With Automatic Transmission</i>	
Water Pump	TF2008	<i>With Manual Transmission</i>	
Timing Belt Kit	TFK067		
<b>Barina MJ</b>			
		10/10-on	4 Cyl 1.2L B12D1
Water Pump	TF8503		
<b>Barina SB</b>			
		4/94-7/97	4 Cyl 1.2L, 1.4L C12NZ, C14NZ
Water Pump	TF3071		
Heater Valve / Tap	TFT2007		
Timing Belt Kit	TFK009		
Timing Belt Kit with Water Pump	TFK009P	<i>Kit contains TF3071 Pump</i>	
<b>Barina SB</b>			
		8/97-2/01	4 Cyl 1.4L C14SE
Water Pump	TF3074		
Timing Belt Kit	TFK009		



Description	Part No	Year & Notes	Engine
<b>HOLDEN</b>			
<b>Barina SB</b>			
		4/94-9/98	4 Cyl 1.6L C16XE, X16XE
Water Pump	TF3072		
Heater Valve / Tap	TFT2007		
Thermostat & Housing	TTH504		
<b>Barina TK</b>			
		10/05-on	4 Cyl 1.6L F16D
Water Pump	TF8273	<i>Pump has Welch Plug</i>	
Thermostat & Housing	TTH549		
Timing Belt Kit	TFK186		
<b>Barina XC</b>			
		2/01-10/05	4 Cyl 1.4L X14XE
Water Pump	TF3072	<i>Belt Driven Engine To Eng. No. 20U75998</i>	
Water Pump	TF8278	<i>Belt Driven Engine From No. 20U75999 mainly Auto from 2004</i>	
Thermostat & Housing	TTH501		
Timing Belt Kit	TFK006	<i>Kit contains small Plastic idler</i>	
Timing Belt Kit	TFK093	<i>Kit contains small Metal idler</i>	
<b>Barina XC</b>			
		1/04-12/05	4 Cyl 1.4L X14XEP
Water Pump	TF8275	<i>Chain Driven Engine From Vin No. 54000001</i>	
Thermostat & Housing	TTH516		
<b>Barina XC</b>			
		9/01-12/05	4 Cyl 1.8L Z18XE
Water Pump	TF4042		
Thermostat & Housing	TTH509		
Timing Belt Kit	TFK006	<i>Kit contains small Plastic idler</i>	
Timing Belt Kit	TFK093	<i>Kit contains small Metal idler</i>	
Timing Belt Kit with Water Pump	TFK4042	<i>Kit contains small Plastic idler &amp; TF4042 Pump</i>	
Timing Belt Kit with Water Pump	TFK093P	<i>Kit contains small Metal idler &amp; TF4042 Pump</i>	
<b>Calibra YE Sohc</b>			
		10/91-7/95	4 Cyl 2.0L C20NE
Water Pump	TF2512	<i>To Engine No. 14608701</i>	
Water Pump	TF8269	<i>From Engine No. 14608702</i>	
<b>Calibra YE</b>			
		10/91-7/95	4 Cyl 2.0L C20NE
Thermostat & Housing	TTH502		
<b>Calibra YE, YE95</b>			
		10/91-1/97	4 Cyl 2.0L C20XE, C20LET
Water Pump	TF8112		
Thermostat & Housing	TTH506		
Timing Belt Kit	TFK005		
Timing Belt Kit with Water Pump	TFK005P	<i>Kit contains TF8112 Pump</i>	

Description	Part No	Year & Notes	Engine
<b>HOLDEN</b>			
<b>Calibra YE, YE95</b>		10/91-11/97	4 Cyl 2.0L X20XEV
Water Pump	TF8112		
Thermostat & Housing	TTH507		
Timing Belt Kit	TFK005		
Timing Belt Kit with Water Pump	TFK005P	<i>Kit contains TF8112 Pump</i>	
<b>Calibra YE95</b>		7/95-1/97	V6 2.5L C25XE
Water Pump	TF8111		
Thermostat & Housing	TTH508		
<b>Camira JB, JD</b>		8/82-3/87	4 Cyl 1.6L, 1.8L 16JH, 18JU, 18JC
Water Pump	TF2189		
Thermostat & Housing	TTH502	<i>11/84 on 1.8L Model only</i>	
<b>Camira JE</b>		4/87-8/89	4 Cyl 2.0L 20JD
Water Pump	TF2512		
<b>Camira JE</b>		4/87-7/89	4 Cyl 2.0L 20JD
Thermostat & Housing	TTH505		
<b>Captiva Turbo Diesel</b>		3/07-on	4 Cyl 2.0L Z20S1T
Water Pump	TF8437		
<b>Captiva CG Series 1 103kW</b>		9/09-1/11	4 Cyl 2.4L F18D4, LD9
Water Pump	TF8454		
Thermostat & Housing	TTH524		
<b>Captiva CG Series 2 123kW</b>		3/11-on	4 Cyl 2.4L LE5
Water Pump	TF8259		
Thermostat & Housing	TTH524		
<b>Captiva CG</b>		3/11-on	6 Cyl 3.0L LF1-SIDI
Water Pump	TF5000		
<b>Captiva</b>		10/06-3/09	V6 3.2L Alloytech
Water Pump	TF5000		
<b>Colorado</b>		7/08-on	4 Cyl 2.4L C24SE, Y24SE
Water Pump	TF8269		
Fan Clutch	TFC233		
Thermostat & Housing	TTH511		

Description	Part No	Year & Notes	Engine
<b>HOLDEN</b>			
<b>Colorado</b>			
		7/08-on	4 Cyl 3.0L 4JJ1TC
Water Pump	TF8308		
<b>Colorado</b>			
		7/08-on	V6 3.6L HFV6
Water Pump	TF5000		
Thermostat & Housing	TTH548		
<b>Combo SB</b>			
		3/96-9/02	4 Cyl 1.4L C14NZ
Water Pump	TF3071		
Heater Valve / Tap	TFT2007		
Timing Belt Kit	TFK009		
Timing Belt Kit with Water Pump	TFK009P	<i>Kit contains TF3071 Pump</i>	
<b>Combo XC</b>			
		12/04-10/07	4 Cyl 1.4L Z14XEP
Water Pump	TF8275		
Thermostat & Housing	TTH516		
<b>Combo XC</b>			
		9/02-4/05	4 Cyl 1.6L Z16SE
Water Pump	TF8106		
Timing Belt Kit	TFK009		
<b>Commodore VB, VC</b>			
		11/78-9/81	6 Cyl 2.8L
Water Pump	TF726		
Fan Clutch	TFC102		
<b>Commodore VB, VC</b>			
		11/78-9/81	4 / 6 Cyl 1.9L, 3.3L
Water Pump	TF814		
Fan Clutch	TFC102		
<b>Commodore VB, VC</b>			
		11/78-9/81	V8 4.2L, 5.0L
Water Pump	TF803/8		
Fan Clutch	TFC102		
<b>Commodore VE</b>			
		7/06-on	V6 3.0L, 3.6L
Water Pump	TF5000		
Thermostat & Housing	TTH548		
Timing Chain Kit	TTCK31		
<b>Commodore VE</b>			
		8/06-on	V8 6.0L Gen 4
Water Pump	TF8406	<i>To 11/08 Check identification guide for position of outlet</i>	
Water Pump	TF8459	<i>From 12/08 check identification guide for position of outlet</i>	

Description	Part No	Year & Notes	Engine
<b>HOLDEN</b>			
<b>Commodore Ute VG</b>			
		<b>8/90-12/91</b>	<b>V6 3.8L</b>
Water Pump	<b>TF9000</b>	<i>Multifit Pump</i>	
Water Pump	<b>TF1039</b>	<i>OE replacement can use TF9000 Multifit Pump</i>	
Heater Valve / Tap	<b>TFT5217</b>	<i>2 Hose connections</i>	
Heater Valve / Tap	<b>TFT5631</b>	<i>4 Hose connections</i>	
<b>Commodore Ute VG</b>			
		<b>8/90-12/91</b>	<b>V8 5.0L</b>
Water Pump	<b>TF1000</b>		
Fan Clutch	<b>TFC102</b>		
Heater Valve / Tap	<b>TFT5217</b>	<i>2 Hose connections</i>	
Heater Valve / Tap	<b>TFT5631</b>	<i>4 Hose connections</i>	
<b>Commodore VH, VK</b>			
		<b>10/81-2/86</b>	<b>4 / 6 Cyl 1.9L, 2.8L, 3.3L</b>
Water Pump	<b>TF815</b>		
Fan Clutch	<b>TFC102</b>		
<b>Commodore VH, VK</b>			
		<b>10/81-2/86</b>	<b>V8 4.2L, 5.0L</b>
Water Pump	<b>TF803/8</b>	<i>Suits Fan with Rounded Top blade &amp; 3947772 stamped on Fan</i>	
Water Pump	<b>TF1000</b>	<i>Suits Fan with Square Top Blade &amp; 92010979 stamped on Fan</i>	
Fan Clutch	<b>TFC102</b>		
<b>Commodore VL</b>			
		<b>3/86-8/88</b>	<b>6 Cyl 3.0L RB30E</b>
Water Pump	<b>TF898</b>		
Fan Clutch	<b>TFC137</b>		
Timing Belt Kit	<b>TFK028</b>		
<b>Commodore VL</b>			
		<b>3/86-8/88</b>	<b>V8 5.0L</b>
Water Pump	<b>TF1000</b>		
Fan Clutch	<b>TFC102</b>		
<b>Commodore VN</b>			
		<b>8/88-10/91</b>	<b>V6 3.8L</b>
Water Pump	<b>TF9000</b>	<i>Multifit Pump</i>	
Water Pump	<b>TF1039</b>	<i>OE Replacement can use TF9000 Multifit Pump</i>	
Heater Valve / Tap	<b>TFT5217</b>	<i>2 Hose connections</i>	
Heater Valve / Tap	<b>TFT5631</b>	<i>4 Hose connections</i>	
<b>Commodore VN</b>			
		<b>8/89-10/91</b>	<b>V8 5.0L</b>
Water Pump	<b>TF1000</b>		
Fan Clutch	<b>TFC102</b>		
Heater Valve / Tap	<b>TFT5217</b>	<i>2 Hose connections</i>	
Heater Valve / Tap	<b>TFT5631</b>	<i>4 Hose connections</i>	

Description	Part No	Year & Notes	Engine
<b>HOLDEN</b>			
<b>Commodore VP, VR</b>			
		<b>10/91-4/95</b>	<b>V6 3.8L</b>
Water Pump	<b>TF9000</b>	<i>Multifit Pump</i>	
Water Pump	<b>TF1039</b>	<i>OE Replacement can use TF9000 Multifit Pump</i>	
Heater Valve / Tap	<b>TFT5217</b>	<i>2 Hose connections</i>	
Heater Valve / Tap	<b>TFT5631</b>	<i>4 Hose connections</i>	
<b>Commodore VP, VR</b>			
		<b>10/91-4/95</b>	<b>V8 5.0L</b>
Water Pump	<b>TF1000</b>		
Fan Clutch	<b>TFC102</b>		
Heater Valve / Tap	<b>TFT5217</b>	<i>2 Hose connections</i>	
Heater Valve / Tap	<b>TFT5631</b>	<i>4 Hose connections</i>	
<b>Commodore VS</b>			
		<b>4/95-8/97</b>	<b>V6 3.8L</b>
Water Pump	<b>TF9000</b>	<i>Multifit Pump</i>	
Water Pump	<b>TF4000</b>	<i>To Engine No. VH515478 OE Replacement</i>	
Water Pump	<b>TF4001</b>	<i>From Engine No. VH515479 OE Replacement</i>	
Heater Valve / Tap	<b>TFT5217</b>	<i>2 Hose connections</i>	
Heater Valve / Tap	<b>TFT5631</b>	<i>4 Hose connections</i>	
<b>Commodore VS</b>			
		<b>4/95-12/00</b>	<b>V8 5.0L</b>
Water Pump	<b>TF1000</b>		
Fan Clutch	<b>TFC102</b>		
Heater Valve / Tap	<b>TFT5217</b>	<i>2 Hose connections</i>	
Heater Valve / Tap	<b>TFT5631</b>	<i>4 Hose connections</i>	
<b>Commodore VT, VU, VX, VY</b>			
		<b>9/97-8/04</b>	<b>V6 3.8L</b>
Water Pump	<b>TF9000</b>	<i>Multifit Pump</i>	
Water Pump	<b>TF4001</b>	<i>OE Replacement can use TF9000 Multifit Pump</i>	
Heater Valve / Tap	<b>TFT5217</b>	<i>2 Hose connections</i>	
Heater Valve / Tap	<b>TFT5631</b>	<i>4 Hose connections</i>	
<b>Commodore VT, VU, VX, VY</b>			
		<b>9/99-8/04</b>	<b>V8 5.7L Gen 3</b>
Water Pump	<b>TF4013</b>	<i>Pump without Thermostat Housing</i>	
Heater Valve / Tap	<b>TFT5217</b>	<i>2 Hose connections</i>	
Heater Valve / Tap	<b>TFT5631</b>	<i>4 Hose connections</i>	
Thermostat & Housing	<b>TTH544</b>	<i>To 1/04 &amp; To Vin No VF040340740</i>	
<b>Commodore VZ</b>			
		<b>8/04-10/07</b>	<b>V6 3.6L</b>
Water Pump	<b>TF5000</b>		
Heater Valve / Tap	<b>TFT2005</b>	<i>To Vin No. 6L852795</i>	
Thermostat & Housing	<b>TTH548</b>		



Description	Part No	Year & Notes	Engine
<b>HOLDEN</b>			
<b>Commodore VZ</b>			
		8/04-10/07	V8 5.7L, 6.0L Gen 3, Gen 4
Water Pump	TF4013	<i>To 8/04 Pump without Thermostat Housing</i>	
Water Pump	TF8406	<i>From 9/04 Pump without Thermostat Housing</i>	
Heater Valve / Tap	TFT5217	<i>2 Hose connections</i>	
Heater Valve / Tap	TFT5631	<i>4 Hose connections</i>	
<b>Cruze YG</b>			
		6/02-6/07	4 Cyl 1.5L M15A
Water Pump	TF8266		
<b>Cruze JG, JH</b>			
		6/09-on	4 Cyl 1.8L F18D
Water Pump	TF8391		
<b>Cruze JG</b>			
		6/09-on	4 Cyl 2.0L Z20S1T
Water Pump	TF8437		
<b>Cruze JH</b>			
		3/11-on	4 Cyl 1.4L
Water Pump	TF8471		
<b>Drover QB</b>			
		3/85-12/87	4 Cyl 1.3L G13A
Water Pump	TF2008		
Radiator Fan Blade	TFB531		
Timing Belt Kit	TFK067		
<b>Epica</b>			
		3/07-7/08	6 Cyl 2.0L, 2.5L X20D1, X25D1
Water Pump	TF8405		
<b>Frontera M7</b>			
		10/95-1/99	4 Cyl 2.0L X20SE
Water Pump	TF8269		
Thermostat & Housing	TTH502		
<b>Frontera UES</b>			
		2/99-1/01	4 Cyl 2.2L X22SE
Water Pump	TF8112		
Thermostat & Housing	TTH524		
Timing Belt Kit	TFK122		
Timing Belt Kit with Water Pump	TFK122P	<i>Kit contains TF8112 Pump</i>	
<b>Frontera MX</b>			
		2/99-1/04	V6 3.2L 6VD1
Water Pump	TF4113		
Fan Clutch	TFC124	<i>7 Blade Fan</i>	
Fan Clutch	TFC191	<i>11 Blade Fan</i>	
Timing Belt Kit	TFK122		

Description	Part No	Year & Notes	Engine
<b>HOLDEN</b>			
<b>Gemini RB, RB2</b>		5/85-6/88	4 Cyl 1.5L 4XC1
<i>Water Pump</i>	<b>TF5019</b>		
<b>Gemini TC,TD,TE,TF,TG, TX</b>		3/75-5/85	4 Cyl 1.6L G161Z
<i>Water Pump</i>	<b>TF827</b>		
<b>Holden FX, FJ, FE, FC, FB, EK, EJ</b>		1948-1/64	6 Cyl All Grey Motor
<i>Water Pump</i>	<b>TF220</b>		
<b>Holden EH, HD, HR, HK</b>		8/63-4/69	6 Cyl All
<i>Water Pump</i>	<b>TF587</b>		
<b>Holden HT, HG</b>		5/69-1/72	6 Cyl All
<i>Water Pump</i>	<b>TF726</b>		
<i>Fan Clutch</i>	<b>TFC102</b>		
<b>Holden HT, HG</b>		5/69-1/72	V8 253, 308ci
<i>Water Pump</i>	<b>TF803/8</b>		
<i>Fan Clutch</i>	<b>TFC102</b>		
<b>Holden HT, HG</b>		5/69-1/72	V8 307,327ci Chevrolet
<i>Water Pump</i>	<b>TF2593</b>		
<b>Holden HT, HG</b>		5/69-1/72	V8 350ci Chevrolet
<i>Water Pump</i>	<b>TF812</b>		
<b>Holden HQ</b>		7/71-9/74	6 Cyl All
<i>Water Pump</i>	<b>TF726</b>		
<i>Fan Clutch</i>	<b>TFC102</b>		
<i>Heater Valve / Tap</i>	<b>TFT5104</b>	<i>Three Way Tap</i>	
<i>Heater Valve / Tap</i>	<b>TFT5105</b>	<i>Two Way Tap</i>	
<b>Holden HQ</b>		7/71-9/74	V8 253, 308ci
<i>Water Pump</i>	<b>TF803/8</b>		
<i>Fan Clutch</i>	<b>TFC102</b>		
<i>Heater Valve / Tap</i>	<b>TFT5104</b>	<i>Three Way Tap</i>	
<i>Heater Valve / Tap</i>	<b>TFT5105</b>	<i>Two Way Tap</i>	
<b>Holden HQ</b>		7/71-9/74	V8 350ci
<i>Water Pump</i>	<b>TF812</b>		
<i>Heater Valve / Tap</i>	<b>TFT5104</b>	<i>Three Way Tap</i>	
<i>Heater Valve / Tap</i>	<b>TFT5105</b>	<i>Two Way Tap</i>	

Description	Part No	Year & Notes	Engine
<b>HOLDEN</b>			
<b>Holden HJ</b>			
		<b>10/74-12/76</b>	<b>6 Cyl All</b>
Water Pump	<b>TF814</b>	<i>Without Air Conditioning</i>	
Water Pump	<b>TF726</b>	<i>With Air Conditioning</i>	
Fan Clutch	<b>TFC102</b>		
Heater Valve / Tap	<b>TFT5104</b>	<i>Three Way Tap</i>	
Heater Valve / Tap	<b>TFT5105</b>	<i>Two Way Tap</i>	
<b>Holden HJ</b>			
		<b>10/74-12/76</b>	<b>V8 253, 308ci</b>
Water Pump	<b>TF803/8</b>		
Fan Clutch	<b>TFC102</b>		
Heater Valve / Tap	<b>TFT5104</b>	<i>Three Way Tap</i>	
Heater Valve / Tap	<b>TFT5105</b>	<i>Two Way Tap</i>	
<b>Holden HX, HZ</b>			
		<b>7/76-12/80</b>	<b>6 Cyl All</b>
Water Pump	<b>TF814</b>	<i>Without Air Conditioning</i>	
Water Pump	<b>TF726</b>	<i>With Air Conditioning</i>	
Fan Clutch	<b>TFC102</b>		
Heater Valve / Tap	<b>TFT5104</b>	<i>Three Way Tap</i>	
Heater Valve / Tap	<b>TFT5105</b>	<i>Two Way Tap</i>	
<b>Holden HX, HZ</b>			
		<b>7/76-3/80</b>	<b>V8 4.2L, 5.0L</b>
Water Pump	<b>TF803/8</b>		
Fan Clutch	<b>TFC102</b>		
Heater Valve / Tap	<b>TFT5104</b>	<i>Three Way Tap</i>	
Heater Valve / Tap	<b>TFT5105</b>	<i>Two Way Tap</i>	
<b>Holden WB</b>			
		<b>4/80-12/85</b>	<b>6 Cyl 3.3L</b>
Water Pump	<b>TF726</b>	<i>Short Shaft 10mm From Hub Face</i>	
Water Pump	<b>TF815</b>	<i>Jumbo Pump 100mm overall height</i>	
Fan Clutch	<b>TFC102</b>		
Heater Valve / Tap	<b>TFT5104</b>	<i>Three Way Tap</i>	
Heater Valve / Tap	<b>TFT5105</b>	<i>Two Way Tap</i>	
<b>Holden WB</b>			
		<b>4/80-12/85</b>	<b>V8 4.2L, 5.0L</b>
Water Pump	<b>TF803/8</b>	<i>Suits Fan with Rounded Top blade &amp; 3947772 stamped on Fan</i>	
Water Pump	<b>TF1000</b>	<i>Suits Fan with Square Top Blade &amp; 92010979 stamped on Fan</i>	
Fan Clutch	<b>TFC102</b>		
Heater Valve / Tap	<b>TFT5104</b>	<i>Three Way Tap</i>	
Heater Valve / Tap	<b>TFT5105</b>	<i>Two Way Tap</i>	
<b>Jackaroo UBS13</b>			
		<b>11/81-7/85</b>	<b>4 Cyl 2.0L G200Z</b>
Water Pump	<b>TF827</b>		

Description	Part No	Year & Notes	Engine
<b>HOLDEN</b>			
<b>Jackaroo UBS16, UBS52 Diesel Incl. Turbo</b>		<b>11/81-12/88</b>	<b>4 Cyl 2.2L C223, C223T</b>
Water Pump	<b>TF5013</b>		
Fan Clutch	<b>TFC119</b>		
Timing Belt Kit	<b>TFK157</b>		
<b>Jackaroo UBS16</b>		<b>8/85-12/88</b>	<b>4 Cyl 2.3L 4ZD1</b>
Water Pump	<b>TF1022</b>		
Fan Clutch	<b>TFC113</b>		
<b>Jackaroo UBS17</b>		<b>7/88-3/92</b>	<b>4 Cyl 2.6L 4ZE1</b>
Water Pump	<b>TF6380</b>		
Fan Clutch	<b>TFC113</b>		
Timing Belt Kit	<b>TFK079</b>		
<b>Jackaroo UBS55 Turbo Diesel</b>		<b>7/88-3/92</b>	<b>4 Cyl 2.8L 4JB1T</b>
Water Pump	<b>TF1100</b>		
Fan Clutch	<b>TFC207</b>		
Timing Belt Kit	<b>TFK157</b>		
<b>Jackaroo U8, UBS26 Turbo Diesel</b>		<b>3/98-9/04</b>	<b>4 Cyl 3.0L 4JX1</b>
Water Pump	<b>TF8263</b>		
Fan Clutch	<b>TFC208</b>		
<b>Jackaroo UBS69 Turbo Diesel</b>		<b>4/92-2/98</b>	<b>4 Cyl 3.1L 4JG2</b>
Water Pump	<b>TF1100</b>	<i>To 3/93</i>	
Water Pump	<b>TF8123</b>	<i>From 4/93</i>	
Timing Belt Kit	<b>TFK157</b>		
<b>Jackaroo UBS25</b>		<b>4/92-2/98</b>	<b>V6 3.2L 6VD1</b>
Water Pump	<b>TF3112</b>		
Fan Clutch	<b>TFC175</b>		
<b>Jackaroo U8, UBS26</b>		<b>2/98-9/04</b>	<b>V6 3.5L 6VE1</b>
Water Pump	<b>TF4113</b>		
Fan Clutch	<b>TFC124</b>	<i>7 Blade Fan</i>	
Timing Belt Kit	<b>TFK168</b>		
Timing Belt Kit with Water Pump	<b>TFK157P</b>	<i>Kit contains TF4113</i>	
<b>Monaro V2</b>		<b>12/01-8/03</b>	<b>V6 3.8L</b>
Water Pump	<b>TF4001</b>	<i>Can use TF9000 Multifit Pump</i>	
<b>Monaro V2, VZ</b>		<b>12/01-6/06</b>	<b>V8 5.7L Gen 3</b>
Water Pump	<b>TF4013</b>	<i>Pump without Thermostat Housing</i>	
Thermostat & Housing	<b>TTH544</b>		

Description	Part No	Year & Notes	Engine
<b>HOLDEN</b>			
<b>Nova LE</b>			
		<b>8/89-8/91</b>	<b>4 Cyl 1.4L 6AFC</b>
Water Pump	<b>TF3039</b>	<i>Pump without Housing</i>	
Water Pump	<b>TF3039H</b>	<i>Pump with Housing</i>	
<b>Nova LE</b>			
		<b>8/89-8/91</b>	<b>4 Cyl 1.6L 4AFC</b>
Water Pump	<b>TF3039</b>	<i>Pump without Housing</i>	
Water Pump	<b>TF3039H</b>	<i>Pump with Housing</i>	
Timing Belt Kit	<b>TFK012</b>		
Timing Belt Kit with Water Pump	<b>TFK012P</b>	<i>Kit contains TF3039</i>	
Timing Belt Kit with Water Pump	<b>TFK012PC</b>	<i>Kit contains TF3039H</i>	
<b>Nova LF</b>			
		<b>9/91-10/92</b>	<b>4 Cyl 1.4L 6AFC</b>
Water Pump	<b>TF3039</b>	<i>Pump without Housing</i>	
Water Pump	<b>TF3039H</b>	<i>Pump with Housing</i>	
<b>Nova LF</b>			
		<b>9/91-10/94</b>	<b>4 Cyl 1.6L 4AFE, 4AFC</b>
Water Pump	<b>TF3039</b>	<i>Pump without Housing</i>	
Water Pump	<b>TF3039H</b>	<i>Pump with Housing</i>	
Timing Belt Kit	<b>TFK015</b>		
Timing Belt Kit with Water Pump	<b>TFK015P</b>	<i>Kit contains TF3039 Pump without Housing</i>	
Timing Belt Kit with Water Pump	<b>TFK015PC</b>	<i>Kit contains TF3039H Pump with Housing</i>	
<b>Nova LF</b>			
		<b>10/92-10/94</b>	<b>4 Cyl 1.8L 7AFE</b>
Water Pump	<b>TF3083</b>	<i>Pump without Housing</i>	
Water Pump	<b>TF4015</b>	<i>Pump with Housing</i>	
Timing Belt Kit	<b>TFK016</b>		
Timing Belt Kit with Water Pump	<b>TFK016P</b>	<i>Kit contains TF3083 Pump without Housing</i>	
Timing Belt Kit with Water Pump	<b>TFK016PC</b>	<i>Kit contains TF4115 Pump with Housing</i>	
<b>Nova LG</b>			
		<b>10/94-9/96</b>	<b>4 Cyl 1.6L 4AFE</b>
Water Pump	<b>TF3084</b>	<i>Pump without Housing</i>	
Water Pump	<b>TF3084H</b>	<i>Pump with Housing</i>	
Timing Belt Kit	<b>TFK015</b>		
<b>Nova LG</b>			
		<b>10/94-9/96</b>	<b>4 Cyl 1.8L 7AFE</b>
Water Pump	<b>TF3083</b>	<i>Pump without Housing</i>	
Water Pump	<b>TF4015</b>	<i>Pump with Housing</i>	
Timing Belt Kit	<b>TFK016</b>		
Timing Belt Kit with Water Pump	<b>TFK016P</b>	<i>Kit contains TF3083 Pump without Housing</i>	
Timing Belt Kit with Water Pump	<b>TFK016PC</b>	<i>Kit contains TF4115 Pump with Housing</i>	
<b>Rodeo KB25 – KB43</b>			
		<b>1/78-3/87</b>	<b>4 Cyl 1.6L, 1.8L, 1.9L G161Z, G180Z, G200Z</b>
Water Pump	<b>TF827</b>		



Description	Part No	Year & Notes	Engine
<b>HOLDEN</b>			
<b>Rodeo</b> KBD26, KBD41 Diesel		1/81-12/82	4 Cyl 2.0L C190
Water Pump	TF864		
<b>Rodeo</b> KBD27 – KBD47 Diesel		1/83-6/88	4 Cyl 2.2L C223
Water Pump	TF5013		
Fan Clutch	TFC119		
<b>Rodeo</b> R9		6/98-2/03	4 Cyl 2.2L C22NE
Water Pump	TF8269		
Fan Clutch	TFC113		
Thermostat & Housing	TTH511		
<b>Rodeo</b> KB29, KB49, TFR16		4/87-3/93	4 Cyl 2.3L 4ZD1
Water Pump	TF1022		
Fan Clutch	TFC113		
<b>Rodeo</b> RA		2/03-7/08	4 Cyl 2.4L C24SE
Water Pump	TF8269		
Fan Clutch	TFC113		
Thermostat & Housing	TTH511		
<b>Rodeo</b> TFR54, TFS54 Diesel		6/88-12/92	4 Cyl 2.5L 4JA1
Water Pump	TF1100		
Fan Clutch	TFC207		
Timing Belt Kit	TFK157		
<b>Rodeo</b> TFR17, TFS17		7/88-6/98	4 Cyl 2.6L 4ZE1
Water Pump	TF6380		
Fan Clutch	TFC113		
Timing Belt Kit	TFK079		
<b>Rodeo</b> TFG, TFR Turbo Diesel		5/90-12/03	4 Cyl 2.8L 4JB1T
Water Pump	TF1100	To 10/94	
Water Pump	TF8123	From 11/94	
Fan Clutch	TFC119	All	
Timing Belt Kit	TFK157	All	
<b>Rodeo</b> TFR9, RA Turbo Diesel		1/02-1/07	4 Cyl 3.0L 4JH1TC
Water Pump	TF8123		
Fan Clutch	TFC207		
Radiator Fan Blade	TFB543		

Description	Part No	Year & Notes	Engine
<b>HOLDEN</b>			
<b>Rodeo RA</b>			
		1/07-on	4 Cyl 3.0L 4JJ1TC
Water Pump	TF8308		
Fan Clutch	TFC222		
<b>Rodeo TFR7,TFR9</b>			
		2/98-10/02	V6 3.2L 6VD1
Water Pump	TF4113		
Fan Clutch	TFC124	7 Blade Fan	
Radiator Fan Blade	TFB542		
Timing Belt Kit	TFK168		
Timing Belt Kit with Water Pump	TFK168P	Kit contains TF4113	
<b>Rodeo RA</b>			
		2/03-12/05	V6 3.5L 6VE1
Water Pump	TF4113		
Fan Clutch	TFC124	To 5/04 With 7 Blade Fan	
Fan Clutch	TFC191	From 6/04 with 11 Blade Fan	
Radiator Fan Blade	TFB542		
Timing Belt Kit	TFK168		
Timing Belt Kit with Water Pump	TFK168P	Kit contains TF4113	
<b>Rodeo RA</b>			
		12/05-on	V6 3.6L HFV6
Water Pump	TF5000		
<b>Scurry NB</b>			
		7/85-12/87	4 Cyl 970cc F10A
Water Pump	TF2003		
<b>Shuttle WFR</b>			
		3/82-3/87	4 Cyl 1.8L 4ZB1
Water Pump	TF5023		
<b>Statesman VQ</b>			
		1/92-3/94	V6 3.8L
Water Pump	TF9000	Multifit Pump	
Water Pump	TF3000	Can use TF9000 Multifit Pump	
Heater Valve / Tap	TFT5217	2 Hose connections	
Heater Valve / Tap	TFT5631	4 Hose connections	
<b>Statesman VQ</b>			
		3/90-3/94	V8 5.0L
Water Pump	TF1000		
Fan Clutch	TFC102		
Heater Valve / Tap	TFT5217	2 Hose connections	
Heater Valve / Tap	TFT5631	4 Hose connections	

Description	Part No	Year & Notes	Engine
<b>HOLDEN</b>			
<b>Statesman VR</b>			
		<b>3/94-4/95</b>	<b>V6 3.8L</b>
Water Pump	<b>TF9000</b>	<i>Multifit Pump</i>	
Water Pump	<b>TF3000</b>	<i>Can use TF9000 Multifit Pump</i>	
Heater Valve / Tap	<b>TFT5217</b>	<i>2 Hose connections</i>	
Heater Valve / Tap	<b>TFT5631</b>	<i>4 Hose connections</i>	
<b>Statesman VR</b>			
		<b>3/94-4/95</b>	<b>V8 5.0L</b>
Water Pump	<b>TF1000</b>		
Fan Clutch	<b>TFC102</b>		
Heater Valve / Tap	<b>TFT5217</b>	<i>2 Hose connections</i>	
Heater Valve / Tap	<b>TFT5631</b>	<i>4 Hose connections</i>	
<b>Statesman VS</b>			
		<b>4/95-6/99</b>	<b>V6 3.8L</b>
Water Pump	<b>TF4000</b>	<i>To Engine No. VH515478 can use TF9000 Multifit Pump</i>	
Water Pump	<b>TF4001</b>	<i>From Engine No. VH515479 can use TF9000 Multifit Pump</i>	
Heater Valve / Tap	<b>TFT5217</b>	<i>2 Hose connections</i>	
Heater Valve / Tap	<b>TFT5631</b>	<i>4 Hose connections</i>	
<b>Statesman VS</b>			
		<b>4/95-6/99</b>	<b>V8 5.0L</b>
Water Pump	<b>TF1000</b>		
Fan Clutch	<b>TFC102</b>		
Heater Valve / Tap	<b>TFT5217</b>	<i>2 Hose connections</i>	
Heater Valve / Tap	<b>TFT5631</b>	<i>4 Hose connections</i>	
<b>Statesman WH</b>			
		<b>6/99-4/03</b>	<b>V6 3.8L</b>
Water Pump	<b>TF9000</b>	<i>Multifit Pump</i>	
Water Pump	<b>TF4001</b>	<i>Can use TF9000 Multifit Pump</i>	
Heater Valve / Tap	<b>TFT5217</b>	<i>2 Hose connections</i>	
Heater Valve / Tap	<b>TFT5631</b>	<i>4 Hose connections</i>	
<b>Statesman WH</b>			
		<b>6/99-4/03</b>	<b>V8 5.7L Gen 3</b>
Water Pump	<b>TF4013</b>	<i>Pump without Thermostat Housing</i>	
Heater Valve / Tap	<b>TFT5217</b>	<i>2 Hose connections</i>	
Heater Valve / Tap	<b>TFT5631</b>	<i>4 Hose connections</i>	
Thermostat & Housing	<b>TTH544</b>	<i>To 1/04 &amp; Vin No VF040340740</i>	
<b>Statesman WK</b>			
		<b>4/03-8/04</b>	<b>V6 3.8L</b>
Water Pump	<b>TF4001</b>	<i>Can use TF9000 Multifit Pump</i>	
Heater Valve / Tap	<b>TFT5217</b>	<i>2 Hose connections</i>	
Heater Valve / Tap	<b>TFT5631</b>	<i>4 Hose connections</i>	

Description	Part No	Year & Notes	Engine
<b>HOLDEN</b>			
<b>Statesman WK</b>			
		<b>4/03-8/04</b>	<b>V8 5.7L Gen 3</b>
Water Pump	<b>TF4013</b>	<i>Pump without Thermostat Housing</i>	
Heater Valve / Tap	<b>TFT5217</b>	<i>2 Hose connections</i>	
Heater Valve / Tap	<b>TFT5631</b>	<i>4 Hose connections</i>	
Thermostat & Housing	<b>TTH544</b>	<i>To 1/04 &amp; Vin No VF040340740</i>	
<b>Statesman WL</b>			
		<b>8/04-8/06</b>	<b>V6 3.6L</b>
Water Pump	<b>TF5000</b>		
Heater Valve / Tap	<b>TFT2005</b>	<i>To Vin No. 6L852795</i>	
Thermostat & Housing	<b>TTH548</b>		
<b>Statesman WL</b>			
		<b>8/04-8/06</b>	<b>V8 5.7L Gen 3</b>
Water Pump	<b>TF4013</b>	<i>Pump without Thermostat Housing</i>	
Heater Valve / Tap	<b>TFT5217</b>	<i>2 Hose connections</i>	
Heater Valve / Tap	<b>TFT5631</b>	<i>4 Hose connections</i>	
<b>Statesman WM</b>			
		<b>8/06-on</b>	<b>V6 3.6L</b>
Water Pump	<b>TF5000</b>		
Thermostat & Housing	<b>TTH548</b>		
Timing Chain Kit	<b>TTCK31</b>		
<b>Statesman WM</b>			
		<b>8/06-on</b>	<b>V8 6.0L, 6.2L Gen 4</b>
Water Pump	<b>TF4013</b>	<i>To 8/10</i>	
Water Pump	<b>TF8406</b>	<i>From 9/10</i>	
<b>Suburban K8 1500</b>			
		<b>2/98-9/00</b>	<b>V8 5.7L L31</b>
Water Pump	<b>TF8107</b>		
<b>Suburban K8 2500 Turbo Diesel</b>			
		<b>2/98-9/00</b>	<b>V8 6.5L FCWG</b>
Water Pump	<b>TF8108</b>	<i>Pump without Pulley</i>	
<b>Sunbird LX, UC</b>			
		<b>8/77-12/80</b>	<b>4 Cyl 1.9L</b>
Water Pump	<b>TF814</b>	<i>From 9/78 with Starfire Engine</i>	
<b>Tigra XC</b>			
		<b>9/05-on</b>	<b>4 Cyl 1.8L Z18XE</b>
Water Pump	<b>TF4042</b>		
Timing Belt Kit	<b>TFK006</b>	<i>Kit contains small Plastic idler</i>	
Timing Belt Kit	<b>TFK093</b>	<i>Kit contains small Metal idler</i>	
Timing Belt Kit with Water Pump	<b>TFK4042</b>	<i>Kit contains small Plastic idler &amp; TF4042 Pump</i>	
Timing Belt Kit with Water Pump	<b>TFK093P</b>	<i>Kit contains small Metal idler &amp; TF4042 Pump</i>	

Description	Part No	Year & Notes	Engine
<b>HOLDEN</b>			
<b>Torana LC</b> excluding GTR-XU1		6/71-1/72	6 Cyl All
Water Pump	TF726		
<b>Torana LC</b> GTR-XU1		6/71-1/72	6 Cyl 186ci
Water Pump	TF587		
<b>Torana LJ</b> Incl. GTR-XU1		2/72-3/74	6 Cyl All
Water Pump	TF726		
<b>Torana LH, LX, UC</b>		3/74-12/79	6 Cyl All
Water Pump	TF814	<i>Long Shaft 20mm From Hub Face</i>	
Water Pump	TF726	<i>Short Shaft 10mm From Hub Face</i>	
Fan Clutch	TFC102	<i>All</i>	
<b>Torana LH, LX</b>		3/74-2/78	V8 253, 308ci
Water Pump	TF803/8		
Fan Clutch	TFC102		
<b>Trax TJ</b>		08/13-On	4 Cyl 1.8L F18D4
Water Pump	TF8391		
<b>Vectra JR</b>		6/97-8/99	4 Cyl 2.0L C20SEL
Water Pump	TF8112		
Heater Valve / Tap	TFT2007		
Thermostat & Housing	TTH507		
Timing Belt Kit	TFK005		
Timing Belt Kit with Water Pump	TFK005P	<i>Kit contains TF8112 Pump</i>	
<b>Vectra JR</b>		6/97-8/98	V6 2.5L X25XE
Water Pump	TF8111		
Heater Valve / Tap	TFT2007		
Thermostat & Housing	TTH508		
<b>Vectra JS</b>		8/99-11/00	4 Cyl 2.0L C20SEL
Water Pump	TF8112		
Heater Valve / Tap	TFT2007		
Thermostat & Housing	TTH507		
Timing Belt Kit	TFK005		
Timing Belt Kit with Water Pump	TFK005P	<i>Kit contains TF8112 Pump</i>	



Description	Part No	Year & Notes	Engine
<b>HOLDEN</b>			
<b>Vectra JS</b>		8/98-12/02	4 Cyl 2.2L C22SEL
Water Pump	TF8112		
Heater Valve / Tap	TFT2007		
Thermostat & Housing	TTH507		
Timing Belt Kit	TFK122		
Timing Belt Kit with Water Pump	TFK122P	<i>Kit contains TF8112 Pump</i>	
<b>Vectra JS</b>		8/99-11/00	V6 2.5L X25XE
Water Pump	TF8111		
Heater Valve / Tap	TFT2007		
Thermostat & Housing	TTH508		
<b>Vectra JS</b>		11/00-3/04	V6 2.6L Y26SE
Water Pump	TF8111		
Heater Valve / Tap	TFT2007		
Thermostat & Housing	TTH508		
<b>Vectra ZC</b>		3/03-12/04	4 Cyl 2.2L Z22SE
Water Pump	TF8259		
Timing Chain Kit	TCK101G	<i>Camshaft kit (kit with Gears)</i>	
Timing Chain Kit	TCK102G	<i>Balance Shaft kit (kit with Gears)</i>	
<b>Vectra ZC</b>		3/03-3/07	V6 3.2L Z32SE
Water Pump	TF8111		
Thermostat & Housing	TTH508		
<b>Viva JF</b>		10/05-12/09	4 Cyl 1.8L F18D
Water Pump	TF8374		
Thermostat & Housing	TTH501		
Timing Belt Kit	TFK006	<i>Kit contains small Plastic idler</i>	
Timing Belt Kit	TFK093	<i>Kit contains small Metal idler</i>	
Timing Belt Kit with Water Pump	TFK093P2	<i>Kit contains small Metal idler &amp; TF8374 Pump</i>	
<b>Zafira TT</b>		6/01-5/06	4 Cyl 2.2L Z22SE
Water Pump	TF8259		
<b>HONDA</b>			
<b>Accord AC</b>		1/79-12/83	4 Cyl 1.6L EL
Water Pump	TF855		
<b>Accord</b>		1/86-12/89	4 Cyl 2.0L A20A2, A20A4
Water Pump	TF2007		

Description	Part No	Year & Notes	Engine
<b>HONDA</b>			
<b>Accord</b>		1/91-12/94	4 Cyl 2.2L F22A
Water Pump	TF3016		
Timing Belt Kit	TFK040		
<b>Accord CE1, CD7, CD9</b>		11/93-12/97	4 Cyl 2.2L F22B1
Water Pump	TF3016		
Timing Belt Kit	TFK044		
<b>Accord</b>		11/89-12/97	4 Cyl 2.2L F22B3
Water Pump	TF3016		
Timing Belt Kit	TFK040		
<b>Accord</b>		1/97-6/03	4 Cyl 2.3L F23A1
Water Pump	TF3016		
Timing Belt Kit	TFK044		
<b>Accord incl. Euro CL9, CM5</b>	incl. VTil	6/03-6/08	4 Cyl 2.4L K24A3, K24A4
Water Pump	TF8338		
Thermostat & Housing	TTH568		
<b>Accord</b>		2/08-on	4 Cyl 2.4L K24Z2
Water Pump	TF8449		
<b>Accord Euro CU</b>		2/10-on	4 Cyl 2.4L K24Z3
Water Pump	TF8449		
Thermostat & Housing	TTH567		
<b>Accord CK1</b>		12/97-6/03	V6 3.0L J30A1
Water Pump	TF8159		
Timing Belt Kit	TFK218	To 8/01	
<b>Accord CM6</b>		1/99-2/08	V6 3.0L J30A1, J30A4
Water Pump	TF8339		
Timing Belt Kit	TFK299		
<b>Accord</b>		2/08-on	V6 3.5L J35Z2
Water Pump	TF8339		
Timing Belt Kit	TFK299		
<b>City</b>		1/84-6/86	4 Cyl 1.2L ER
Water Pump	TF907		
<b>Civic</b>		11/79-12/83	4 Cyl 1.3L EN1
Water Pump	TF843		

Description	Part No	Year & Notes	Engine
<b>HONDA</b>			
<b>Civic EG</b>		10/91-10/93	4 Cyl 1.3L D13B2
Water Pump	TF1130		
Timing Belt Kit	TFK038		
<b>Civic</b>		2/04-on	4 Cyl 1.3L LDA
Water Pump	TF8450	<i>Without Pulley</i>	
<b>Civic AL</b>		1/84-10/87	4 Cyl 1.5L EW2
Water Pump	TF1120		
<b>Civic ED, EE, EG</b>		5/88-10/95	4 Cyl 1.5L D15B
Water Pump	TF1130		
Timing Belt Kit	TFK038		
<b>Civic Breeze EG</b>		2/93-10/95	4 Cyl 1.5L D15Z2
Water Pump	TF1132		
Timing Belt Kit	TFK038		
<b>Civic EG Dohc</b>		10/91-10/93	4 Cyl 1.6L D16A8
Water Pump	TF1130		
<b>Civic Vti EH Sohc</b>		10/93-9/95	4 Cyl 1.6L D16Y1
Water Pump	TF1132		
Timing Belt Kit	TFK127		
<b>Civic EJ, EK Sohc</b>		10/95-10/00	4 Cyl 1.6L D16Y4, D16Y5, D16Y8
Water Pump	TF8156		
Timing Belt Kit	TFK127		
Timing Belt Kit with Water Pump	TFK127P	<i>Kit contains TF8156 Pump</i>	
<b>Civic Vti-R EK, EM Dohc</b>		10/95-9/00	4 Cyl 1.6L B16A2
Water Pump	TF8207		
<b>Civic ES, EU</b>		10/00-1/06	4 Cyl 1.7L D17Z1, D17A2
Water Pump	TF8161		
Timing Belt Kit	TFK220		
<b>Civic</b>		2/06-on	4 Cyl 1.8L R18A1
Water Pump	TF8341		
<b>Civic R30</b>		2/06-on	4 Cyl 2.0L K20Z2
Water Pump	TF8340		

Description	Part No	Year & Notes	Engine
<b>HONDA</b>			
<b>Concerto</b>		11/88-1/94	4 Cyl 1.6L D16Z2
Water Pump	TF1130		
<b>CRV</b>		9/97-12/01	4 Cyl 2.0L B20B3
Water Pump	TF4003		
Timing Belt Kit	TFK138		
<b>CRV</b>		12/01-2/07	4 Cyl 2.4L K24A1
Water Pump	TF8162		
Thermostat & Housing	TTH566		
<b>CRV</b>		2/07-on	4 Cyl 2.4L K24Z1
Water Pump	TF8340		
<b>CRX ED9</b>		11/87-5/92	4 Cyl 1.6L D16A8
Water Pump	TF1130		
<b>CRX EG2</b>		6/92-9/98	4 Cyl 1.6L B16A2
Water Pump	TF8157		
<b>HRV</b>		1/99-7/02	4 Cyl 1.6L D16W1
Water Pump	TF8156		
Timing Belt Kit	TFK127		
Timing Belt Kit with Water Pump	TFK127P	<i>Kit contains TF8156 Pump</i>	
<b>Integra DA9</b>		6/89-7/93	4 Cyl 1.8L B18A
Water Pump	TF3018	<i>19 Teeth Spline</i>	
<b>Integra DC2, DC4</b>		7/93-7/01	4 Cyl 1.8L B18A1, B18B1, B18C2, B18C7
Water Pump	TF3018	<i>Check Engine Code &amp; Spline -19 Teeth</i>	
Water Pump	TF8207	<i>Check Engine Code &amp; Spline -22 Teeth</i>	
<b>Integra DC5</b>		8/01-3/07	4 Cyl 2.0L K20A2, K20A3, K20KZ1
Water Pump	TF8162		
Thermostat & Housing	TTH566		
<b>Jazz GD1, GD3</b>		10/02-8/08	4 Cyl 1.3L, 1.5L L13A1, L15A1
Water Pump	TF8164		
<b>Jazz</b>		9/08-on	4 Cyl 1.3L L13A1, L13Z1
Water Pump	TF8442		
<b>Jazz</b>		9/08-on	4 Cyl 1.5L L15A7
Water Pump	TF8442		

Description	Part No	Year & Notes	Engine
<b>HONDA</b>			
<b>Legend</b>		5/86-3/91	V6 2.5L, 2.7L C25A1, C27A1
Water Pump	TF2025		
<b>Legend</b>		4/91-3/96	V6 3.2L C32A3
Water Pump	TF3063	<i>Twin Outlets</i>	
<b>Legend</b>		5/96-1/05	V6 3.5L C35A3
Water Pump	TF8158		
<b>MDX</b>		4/03-3/07	V6 3.5L J35A5
Water Pump	TF8159		
Timing Belt Kit	TFK299		
<b>Odyssey RA1</b>		6/95-1/98	4 Cyl 2.2L F22B6
Water Pump	TF3016		
Timing Belt Kit	TFK040		
<b>Odyssey RA3</b>		1/98-12/04	4 Cyl 2.3L F23Z, F23A1
Water Pump	TF3016		
Timing Belt Kit	TFK044		
<b>Odyssey RB1</b>		6/04-on	4 Cyl 2.4L K24A4, K24Z2
Water Pump	TF8340		
Thermostat & Housing	TTH568		
<b>Odyssey RA8</b>		3/00-6/04	V6 3.0L J30A3
Water Pump	TF8159		
Timing Belt Kit	TFK218		
<b>Prelude</b>		5/79-1/82	4 Cyl 1.6L EL
Water Pump	TF855	<i>With Large 45mm Hub</i>	
<b>Prelude Sohc</b>		1/86-9/87	4 Cyl 2.0L A20A4
Water Pump	TF2007		
<b>Prelude Dohc</b>		8/91-12/91	4 Cyl 2.0L B20A6
Water Pump	TF3019		
<b>Prelude</b>		12/91-2/97	4 Cyl 2.2L F22A
Water Pump	TF3016		
Timing Belt Kit	TFK040		
<b>Prelude</b>		2/97-5/02	4 Cyl 2.2L F22Z6
Water Pump	TF3016		



Description	Part No	Year & Notes	Engine
<b>HONDA</b>			
<b>Prelude</b>		2/94-7/02	4 Cyl 2.2L H22A1, H22A4
Water Pump	TF8155		
Timing Belt Kit	TFK140		
<b>Prelude</b>		12/91-12/96	4 Cyl 2.3L H23A1
Water Pump	TF3087		
<b>S2000</b>		8/99-on	4 Cyl 2.0L F20C1
Water Pump	TF8165		
<b>HYUNDAI</b>			
<b>Accent</b>		6/00-on	4 Cyl 1.5L, 1.6L G4ECX, G4ED2
Water Pump	TF4040	<i>Alternator mounting hole 14mm high</i>	
Water Pump	TF8458	<i>Alternator mounting hole 24mm high</i>	
Timing Belt Kit	TFK124		
Timing Belt Kit with Water Pump	TFK124P	<i>Kit contains TF8458 Pump</i>	
<b>Coupe FX, SFX, SX, RD</b>		8/96-3/03	4 Cyl 1.8L G4GM
Water Pump	TF4043		
Timing Belt Kit	TFK175		
<b>Coupe FX, SFX, SX, RD</b>		8/96-3/03	4 Cyl 2.0L G4GC
Water Pump	TF4043		
Timing Belt Kit	TFK177		
Timing Belt Kit with Water Pump	TFK284P	<i>Kit contains TF4043 Pump</i>	
<b>Elantra</b>		10/00-9/03	4 Cyl 1.8L G4GM
Water Pump	TF8171		
Timing Belt Kit	TFK175		
Timing Belt Kit with Water Pump	TFK175P	<i>Kit contains TF8171 Pump</i>	
<b>Elantra</b>		10/00-on	4 Cyl 2.0L G4GC
Water Pump	TF8171		
Timing Belt Kit	TFK177		
Timing Belt Kit with Water Pump	TFK177P	<i>Kit contains TF8171 Pump</i>	
<b>Excel X1 Sohc</b>		2/86-12/90	4 Cyl 1.5L G4AJ
Water Pump	TF877		
<b>Excel X2 Sohc</b>		1/90-9/94	4 Cyl 1.5L G4DJ
Water Pump	TF877		
Timing Belt Kit	TFK063		

Description	Part No	Year & Notes	Engine
<b>HYUNDAI</b>			
<b>Excel X3 Sohc</b>		<b>1/94-1/98</b>	<b>4 Cyl 1.5L G4EK</b>
Water Pump	<b>TF877</b>		
Timing Belt Kit	<b>TFK082</b>		
Timing Belt Kit with Water Pump	<b>TFK082P</b>	<i>Kit contains TF877 Pump</i>	
<b>Excel X3 Dohc</b>		<b>1/98-3/00</b>	<b>4 Cyl 1.5L G4FK</b>
Water Pump	<b>TF4040</b>		
Timing Belt Kit	<b>TFK124</b>		
<b>Getz TB</b>		<b>2/03-10/05</b>	<b>4 Cyl 1.3L G4EA2</b>
Water Pump	<b>TF4040</b>	<i>Alternator mounting hole 14mm high</i>	
<b>Getz TB</b>		<b>10/05-on</b>	<b>4 Cyl 1.4L G4EE</b>
Water Pump	<b>TF4040</b>	<i>Alternator mounting hole 14mm high</i>	
Water Pump	<b>TF8458</b>	<i>Alternator mounting hole 24mm high</i>	
Timing Belt Kit	<b>TFK124</b>		
Timing Belt Kit with Water Pump	<b>TFK124P</b>	<i>Kit contains TF8458 Pump</i>	
<b>Getz TB</b>		<b>9/02-on</b>	<b>4 Cyl 1.5L,1.6L G4EA, G4EC, G4ED, G4EE</b>
Water Pump	<b>TF4040</b>	<i>Alternator mounting hole 14mm high</i>	
Water Pump	<b>TF8458</b>	<i>Alternator mounting hole 24mm high</i>	
Timing Belt Kit	<b>TFK124</b>		
Timing Belt Kit with Water Pump	<b>TFK124P</b>	<i>Kit contains TF8458 Pump</i>	
<b>Grandeur Turbo Diesel</b>		<b>9/08-on</b>	<b>4 Cyl 2.2L G6DB4S</b>
Water Pump	<b>TF8403</b>		
<b>Grandeur TG Turbo Diesel</b>		<b>6/10-on</b>	<b>4 Cyl 2.2L D4EB</b>
Water Pump	<b>TF8403</b>		
<b>Grandeur T41</b>		<b>9/99-4/03</b>	<b>V6 3.0L G6CT</b>
Water Pump	<b>TF4105</b>		
<b>Grandeur C41</b>		<b>2/06-on</b>	<b>V6 3.8L G6DA5</b>
Water Pump	<b>TF8350</b>		
<b>i20</b>		<b>7/10-on</b>	<b>4 Cyl 1.4L G4FA</b>
Water Pump	<b>TF8439</b>		
<b>i30 Turbo Diesel</b>		<b>10/07-on</b>	<b>4 Cyl 1.6L D4FB</b>
Water Pump	<b>TF8392</b>	<i>To 12/07</i>	
Water Pump	<b>TF8438</b>	<i>From 12/07</i>	
Thermostat & Housing	<b>TTH571</b>		

Description	Part No	Year & Notes	Engine
<b>HYUNDAI</b>			
<b>i30 Petrol</b>		<b>1/10-on</b>	<b>4 Cyl 1.6L G4FC</b>
Water Pump	<b>TF8439</b>		
<b>i30</b>		<b>10/07-on</b>	<b>4 Cyl 2.0L G4GC</b>
Water Pump	<b>TF8171</b>		
<b>iX35</b>		<b>1/10-on</b>	<b>4 Cyl 2.0L D4HA</b>
Water Pump	<b>TF8493</b>		
<b>iX35 LM</b>		<b>2/10-on</b>	<b>4 Cyl 2.0L G4KD</b>
Water Pump	<b>TF8490</b>	<i>Pump without Housing</i>	
Water Pump	<b>TF8494</b>	<i>Pump with Housing</i>	
<b>i45 Petrol</b>		<b>5/10-on</b>	<b>4 Cyl 2.4L G4KC</b>
Water Pump	<b>TF8444</b>	<i>Without Housing</i>	
Water Pump	<b>TF8444H</b>	<i>With Housing</i>	
<b>iLoad TQ Petrol</b>		<b>1/08-on</b>	<b>4 Cyl 2.4L G4KG8</b>
Water Pump	<b>TF8445</b>	<i>Without Housing</i>	
Water Pump	<b>TF8445H</b>	<i>With Housing</i>	
<b>iLoad / iMax TQ Turbo Diesel</b>		<b>1/08-on</b>	<b>4 Cyl 2.5L G4KG9</b>
Water Pump	<b>TF8378</b>	<i>To 2/12</i>	
Water Pump	<b>TF8504</b>	<i>From 2/12</i>	
Radiator Fan Blade	<b>TFB541</b>		
<b>Lantra</b>		<b>5/91-10/92</b>	<b>4 Cyl 1.6L G4CR</b>
Water Pump	<b>TF3020</b>		
<b>Lantra</b>		<b>11/92-8/95</b>	<b>4 Cyl 1.8L G4CN</b>
Water Pump	<b>TF3060</b>		
Timing Belt Kit	<b>TFK059</b>		
<b>Lantra J2</b>		<b>8/95-10/00</b>	<b>4 Cyl 1.8L G4GM</b>
Water Pump	<b>TF4043</b>		
Timing Belt Kit	<b>TFK175</b>		
<b>Lantra J3</b>		<b>2/99-10/00</b>	<b>4 Cyl 2.0L G4GC</b>
Water Pump	<b>TF4043</b>		
Timing Belt Kit	<b>TFK177</b>		
Timing Belt Kit with Water Pump	<b>TFK284P</b>	<i>Kit contains TF4043 Pump</i>	

Description	Part No	Year & Notes	Engine
<b>HYUNDAI</b>			
<b>Santa Fe CM Turbo Diesel</b>		10/06- on	4 Cyl 2.2L D4EB6
<i>Water Pump</i>	<b>TF8403</b>		
<b>Santa Fe CM, DM Turbo Diesel</b>		11/09-7/12	4 Cyl 2.2L D4HB
<i>Water Pump</i>	<b>TF8493</b>		
<b>Santa Fe B81</b>		1/01-9/03	4 Cyl 2.4L G4JS
<i>Water Pump</i>	<b>TF4104</b>		
<b>Santa Fe</b>		9/00-5/06	V6 2.7L G6BA
<i>Water Pump</i>	<b>TF8175</b>		
<i>Timing Belt Kit</i>	<b>TFK178</b>		
<b>Santa Fe</b>		5/06-on	V6 2.7L G6EA5
<i>Water Pump</i>	<b>TF8393</b>		
<b>Santa Fe</b>		7/07-On	V6 3.3L LAMBDA
<i>Water Pump</i>	<b>TF8350</b>		
<b>Santa Fe FE</b>		01/11-on	V6 3.5L G6DE
<i>Water Pump</i>	<b>TF8470</b>		
<b>Sonata EF</b>		8/98-3/01	4 Cyl 2.0L G4JP
<i>Water Pump</i>	<b>TF4104</b>		
<i>Timing Belt Kit</i>	<b>TFK059</b>		
<b>Sonata F21</b>		10/93-8/98	4 Cyl 2.0L G4CP
<i>Water Pump</i>	<b>TF3060</b>		
<b>Sonata NF CRDi</b>		6/08-on	4 Cyl 2.0L Theta
<i>Water Pump</i>	<b>TF8403</b>		
<b>Sonata F21</b>		3/89-3/90	4 Cyl 2.4L G4CS
<i>Water Pump</i>	<b>TF1027</b>		
<b>Sonata EF-B</b>		9/01-6/05	4 Cyl 2.4L G4JSY
<i>Water Pump</i>	<b>TF4104</b>		
<b>Sonata NF</b>		6/05-6/08	4 Cyl 2.4L G4KC
<i>Water Pump</i>	<b>TF8348</b>	<i>Without Housing</i>	
<i>Water Pump</i>	<b>TF8348H</b>	<i>With Housing</i>	

Description	Part No	Year & Notes	Engine
<b>HYUNDAI</b>			
<b>Sonata</b>			
		8/98-5/05	V6 2.5L, 2.7L G6BV, G6BA
Water Pump	TF8175		
Timing Belt Kit	TFK178		
<b>Sonata F21, F31</b>			
		4/90-8/98	V6 3.0L G6AT
Water Pump	TF2040	<i>Pump without Housing 40.5mm OD O-Ring</i>	
Water Pump	TF3114	<i>Pump with Housing</i>	
Timing Belt Kit	TFK058		
Timing Belt Kit	TFK058P	<i>Kit contains TF2040 Pump</i>	
<b>Sonata NF</b>			
		6/05-6/08	V6 3.3L G6DB
Water Pump	TF8350		
<b>S-Coupe 1J</b>			
		7/90-10/92	4 Cyl 1.5L G4DJ
Water Pump	TF877		
Timing Belt Kit	TFK063		
<b>S-Coupe 1N</b>			
		7/90-5/96	4 Cyl 1.5L G4EK
Water Pump	TF877		
Timing Belt Kit	TFK082		
Timing Belt Kit with Water Pump	TFK082P	<i>Kit contains TF877 Pump</i>	
<b>Terracan</b>			
		1/05-1/08	4 Cyl 2.9L J3
Water Pump	TF8352		
Fan Clutch	TFC183		
<b>Terracan</b>			
		11/01-1/08	V6 3.5L G6CU
Water Pump	TF8176	<i>Pump without Housing</i>	
Water Pump	TF8176H	<i>Pump with Housing</i>	
Fan Clutch	TFC183		
<b>Tiburon</b>			
		2/02-5/04	4 Cyl 2.0L G4GC
Water Pump	TF8171		
Timing Belt Kit	TFK177		
Timing Belt Kit with Water Pump	TFK177P	<i>Kit contains TF8171 Pump</i>	
<b>Tiburon</b>			
		3/02-on	V6 2.7L G6BA
Water Pump	TF8175		
Timing Belt Kit	TFK178		
<b>Trajet</b>			
		7/00-6/08	V6 2.7L G6BA
Water Pump	TF8175		
Timing Belt Kit	TFK178		



Description	Part No	Year & Notes	Engine
<b>HYUNDAI</b>			
<b>Tucson City</b>		11/05-on	4 Cyl 2.0L G4GC
Water Pump	TF8171		
<b>Tucson</b>		8/04-on	V6 2.7L G6BA
Water Pump	TF8175		
Timing Belt Kit	TFK178		
<b>ISUZU</b>			
<b>NKR, NPR Series</b>		1982-on	4 Cyl 3.3L 4BC2
Water Pump	TF3004		
<b>NKR, NPR Series</b>		1980-on	4 Cyl 3.8L 4BD1
Water Pump	TF3003		
<b>NKR, NPR Series</b>		1987-on	4 Cyl 3.3L 4BE1
Water Pump	TF3004		
<b>D-Max</b>		10/08-on	4 Cyl 3.0L 4JJTC
Water Pump	TF8308		
<b>JAGUAR</b>			
<b>XJ6</b>		74-3/87	6 Cyl 4.2L AL8
Water Pump	TF840	To 4/79	
Water Pump	TF880	From 4/79	
<b>JEEP</b>			
<b>Cherokee KJ</b>		9/01-11/03	4 Cyl 2.5L VM
Water Pump	TF8478	To 2003	
Water Pump	TF8480	From 2003	
<b>Cherokee KJ</b>		2/04-12/05	4 Cyl 2.4L 4W
Water Pump	TF8354		
<b>Cherokee XJ Turbo Diesel</b>		8/97-9/01	4 Cyl 2.5L VM
Water Pump	TF8210		
<b>Cherokee KJ Turbo Diesel</b>		2/03-3/08	4 Cyl 2.8L 3W
Water Pump	TF8210		

Description	Part No	Year & Notes	Engine
<b>JEEP</b>			
<b>Cherokee KK Turbo Diesel</b>		<b>3/08-on</b>	<b>4 Cyl 2.8L 7L</b>
<i>Water Pump</i>	<b>TF8481</b>		
<b>Cherokee KJ Petrol</b>		<b>9/01-3/08</b>	<b>V6 3.7L 2W</b>
<i>Water Pump</i>	<b>TF8109</b>		
<b>Cherokee KK Petrol</b>		<b>3/08-on</b>	<b>V6 3.7L 8W</b>
<i>Water Pump</i>	<b>TF8109</b>		
<b>Cherokee XJ Ohv</b>		<b>4/94-9/01</b>	<b>6 Cyl 4.0L MX</b>
<i>Water Pump</i>	<b>TF3133</b>		
<i>Fan Clutch</i>	<b>TFC177</b>		
<i>Heater Valve / Tap</i>	<b>TFT6315</b>		
<b>Grand Cherokee WG</b>		<b>3/03-6/05</b>	<b>5 Cyl 2.7L 3Y</b>
<i>Water Pump</i>	<b>TF8479</b>		
<b>Grand Cherokee WH Turbo Diesel</b>		<b>4/06-on</b>	<b>V6 3.0L OM642</b>
<i>Water Pump</i>	<b>TF8431</b>	<i>7 Rib Pulley</i>	
<b>Grand Cherokee WH</b>		<b>4/07-7/08</b>	<b>V6 3.7L 2W</b>
<i>Water Pump</i>	<b>TF8109</b>		
<b>Grand Cherokee WJ, ZG, ZJ</b>		<b>3/96-6/05</b>	<b>6 Cyl 4.0L MX</b>
<i>Water Pump</i>	<b>TF4100</b>	<i>To 6/99</i>	
<i>Water Pump</i>	<b>TF4101</b>	<i>From 7/99</i>	
<i>Fan Clutch</i>	<b>TFC121</b>	<i>To 6/99</i>	
<b>Grand Cherokee WG, WH, WJ</b>		<b>6/99-on</b>	<b>V8 4.7L 8N</b>
<i>Water Pump</i>	<b>TF8109</b>	<i>8 Rib Pulley</i>	
<b>Grand Cherokee WH</b>		<b>7/05-on</b>	<b>V8 5.7L 5Y</b>
<i>Water Pump</i>	<b>TF8357</b>		
<b>Grand Cherokee WH</b>		<b>8/06-on</b>	<b>V8 6.1L ESF</b>
<i>Water Pump</i>	<b>TF8395</b>		
<b>Patriot MK Turbo Diesel</b>		<b>8/07-on</b>	<b>4 Cyl 2.0L</b>
<i>Water Pump</i>	<b>TF8435</b>		
<b>Patriot MK</b>		<b>8/07-on</b>	<b>4 Cyl 2.4L ED3</b>
<i>Water Pump</i>	<b>TF8366</b>	<i>Without Housing</i>	
<i>Water Pump</i>	<b>TF8366H</b>	<i>With Housing</i>	

Description	Part No	Year & Notes	Engine
<b>JEEP</b>			
<b>Wrangler JK Turbo Diesel</b>		<b>2/07-on</b>	<b>4 Cyl 2.8L 3W</b>
Water Pump	<b>TF8210</b>		
<b>Wrangler JK Petrol</b>		<b>6/06-on</b>	<b>V6 3.8L 7L</b>
Water Pump	<b>TF8396</b>		
<b>Wrangler TJ Ohv</b>		<b>11/96-2/08</b>	<b>6 Cyl 4.0L MX</b>
Water Pump	<b>TF4100</b>	<i>To 6/99</i>	
Water Pump	<b>TF4101</b>	<i>From 7/99</i>	
Fan Clutch	<b>TFC224</b>	<i>To 6/99</i>	
<b>KIA</b>			
<b>Carens</b>		<b>7/00-10/02</b>	<b>4 Cyl 1.8L TB</b>
Water Pump	<b>TF8192</b>		
<b>Carnival</b>		<b>9/99-8/06</b>	<b>V6 2.5L KV6</b>
Water Pump	<b>TF8196</b>		
Timing Belt Kit	<b>TFK181</b>		
<b>Carnival VQ</b>		<b>3/07-6/10</b>	<b>V6 2.7L G6EA</b>
Water Pump	<b>TF8393</b>		
<b>Grand Carnival VQ Turbo Diesel</b>		<b>2/09-on</b>	<b>4 Cyl 2.9L J3</b>
Water Pump	<b>TF8441</b>		
<b>Grand Carnival VQ Petrol</b>		<b>1/06-on</b>	<b>V6 3.8L G6DA5</b>
Water Pump	<b>TF8350</b>		
<b>Grand Carnival VQ</b>		<b>06/10-on</b>	<b>V6 3.5L G6DC</b>
Water Pump	<b>TF8470</b>		
<b>Cerato LD</b>		<b>6/04-1/09</b>	<b>4 Cyl 2.0L G4GC</b>
Water Pump	<b>TF8171</b>		
Timing Belt Kit	<b>TFK177</b>		
Timing Belt Kit with Water Pump	<b>TFK177P</b>	<i>Kit contains TF8171 Pump</i>	
<b>Cerato TD</b>		<b>9/09-on</b>	<b>4 Cyl 2.0L G4KD8H</b>
Water Pump	<b>TF8497</b>	<i>To 6/10 Pump without Housing</i>	
Water Pump	<b>TF8497H</b>	<i>To 6/10 Pump with Housing &amp; Pulley</i>	
Water Pump	<b>TF8498</b>	<i>From 7/10 Pump without Housing</i>	
Water Pump	<b>TF8498H</b>	<i>From 7/10 Pump with Housing &amp; Pulley</i>	

Description	Part No	Year & Notes	Engine
<b>KIA</b>			
<b>Ceres Diesel</b>		<b>6/92-12/96</b>	<b>4 Cyl 2.2L S2</b>
Water Pump	<b>TF1028</b>		
<b>Ceres Diesel</b>		<b>1/94-1/01</b>	<b>4 Cyl 2.4L SC</b>
Water Pump	<b>TF8195</b>		
<b>Credos</b>		<b>5/98-4/01</b>	<b>4 Cyl 2.0L FE</b>
Water Pump	<b>TF7095</b>		
<b>K2700 Diesel</b>		<b>10/02-12/08</b>	<b>4 Cyl 2.7L J2</b>
Water Pump	<b>TF8194</b>	<i>To 1/05 Shaft OD. 15.6mm: Height 76mm</i>	
Water Pump	<b>TF8501</b>	<i>From 2/05 Shaft OD. 17.7mm -Height 70mm</i>	
Fan Clutch	<b>TFC205</b>	<i>To 1/05</i>	
<b>K2900 Turbo Diesel</b>		<b>3/08-on</b>	<b>4 Cyl 2.9L J312</b>
Water Pump	<b>TF8368</b>		
Radiator Fan Blade	<b>TFB541</b>		
<b>Magentis</b>		<b>9/06-on</b>	<b>4 Cyl 2.4L G4KC</b>
Water Pump	<b>TF8348</b>	<i>Without Housing</i>	
Water Pump	<b>TF8348H</b>	<i>With Housing</i>	
<b>Magentis</b>		<b>9/06-10/08</b>	<b>V6 2.7L G6EA</b>
Water Pump	<b>TF8393</b>		
<b>Mentor</b>		<b>11/96-4/99</b>	<b>4 Cyl 1.5L B5</b>
Water Pump	<b>TF1020</b>		
Timing Belt Kit	<b>TFK049</b>		
Timing Belt Kit with Water Pump	<b>TFK049P</b>	<i>Kit contains TF1020 Pump</i>	
<b>Mentor</b>		<b>4/98-10/00</b>	<b>4 Cyl 1.5L BF</b>
Water Pump	<b>TF3010</b>		
Timing Belt Kit	<b>TFK050</b>		
<b>Mentor</b>		<b>5/98-4/01</b>	<b>4 Cyl 1.8L TE</b>
Water Pump	<b>TF8192</b>		
<b>Optima</b>		<b>5/01-1/04</b>	<b>V6 2.5L G6BV</b>
Water Pump	<b>TF8175</b>		
Timing Belt Kit	<b>TFK178</b>		
<b>Optima</b>		<b>5/01-1/07</b>	<b>V6 2.7L G6BA</b>
Water Pump	<b>TF8175</b>		
Timing Belt Kit	<b>TFK178</b>		

Description	Part No	Year & Notes	Engine
<b>KIA</b>			
<b>Pregio OHV Diesel</b>		<b>7/02-3/07</b>	<b>4 Cyl 2.7L J2</b>
Water Pump	<b>TF8194</b>		
Fan Clutch	<b>TFC205</b>		
Radiator Fan Blade	<b>TFB541</b>		
<b>Rio BC</b>		<b>7/00-12/05</b>	<b>4 Cyl 1.5L A5D</b>
Water Pump	<b>TF8193</b>	<i>To 12/02</i>	
Water Pump	<b>TF8174</b>	<i>From 1/03</i>	
Timing Belt Kit	<b>TFK180</b>		
Timing Belt Kit with Water Pump	<b>TFK108P</b>	<i>Kit contains TF8193 Pump To 12/02</i>	
<b>Rio JB</b>		<b>3/07-on</b>	<b>4 Cyl 1.4L G4EE</b>
Water Pump	<b>TF4040</b>	<i>Alternator mounting hole 14mm high</i>	
Water Pump	<b>TF8458</b>	<i>Alternator mounting hole 24mm high</i>	
Timing Belt Kit	<b>TFK124</b>		
Timing Belt Kit with Water Pump	<b>TFK124P</b>	<i>Kit contains TF8458 Pump</i>	
<b>Rio JB</b>		<b>8/05-on</b>	<b>4 Cyl 1.6L G4ED</b>
Water Pump	<b>TF4040</b>	<i>Alternator mounting hole 14mm high</i>	
Water Pump	<b>TF8458</b>	<i>Alternator mounting hole 24mm high</i>	
Timing Belt Kit	<b>TFK124</b>		
Timing Belt Kit with Water Pump	<b>TFK124P</b>	<i>Kit contains TF8458 Pump</i>	
<b>Rondo</b>		<b>4/08-on</b>	<b>4 Cyl 2.0L G4KAH</b>
Water Pump	<b>TF8348</b>	<i>Without Housing</i>	
Water Pump	<b>TF8348H</b>	<i>With Housing</i>	
<b>Shuma</b>		<b>4/00-5/02</b>	<b>4 Cyl 1.8L TE</b>
Water Pump	<b>TF8192</b>		
<b>Sorento BL Turbo Diesel</b>		<b>8/07-12/09</b>	<b>4 Cyl 2.5L D4CD</b>
Water Pump	<b>TF8378</b>		
Radiator Fan Blade	<b>TFB541</b>		
<b>Sorento XM</b>		<b>10/09-on</b>	<b>4 Cyl 2.2L D4HBA</b>
Water Pump	<b>TF8493</b>		
<b>Sorento BL</b>		<b>8/07-12/09</b>	<b>V6 3.3L G6DB</b>
Water Pump	<b>TF8350</b>		
<b>Sorento BL</b>		<b>2/03-3/07</b>	<b>V6 3.5L G6CU</b>
Water Pump	<b>TF8176</b>	<i>Pump without Housing</i>	
Water Pump	<b>TF8176H</b>	<i>Pump with Housing</i>	



Description	Part No	Year & Notes	Engine
<b>KIA</b>			
<b>Sorento BL</b>		1/07-2/08	V6 3.8L G6DA
Water Pump	TF8350		
<b>Soul Turbo Diesel</b>		4/09-on	4 Cyl 1.6L D4FB
Water Pump	TF8438		
Thermostat & Housing	TTH572		
<b>Soul Petrol</b>		4/09-on	4 Cyl 1.6L G4FC
Water Pump	TF8439		
<b>Spectra</b>		5/01-11/04	4 Cyl 1.8L TE
Water Pump	TF8192		
<b>Sportage JA55</b>		11/96-7/03	4 Cyl 2.0L FED
Water Pump	TF7095		
Fan Clutch / Fan	TFC200	To 6/01 Complete with Fan	
<b>Sportage KM2 Turbo Diesel</b>		8/07-on	4 Cyl 2.0L D4EA
Water Pump	TF8403		
<b>Sportage KM2 Petrol</b>		8/07-on	4 Cyl 2.0L G4GC
Water Pump	TF8171		
<b>Sportage</b>		4/05-8/09	V6 2.7L G6BA
Water Pump	TF8175		
Timing Belt Kit	TFK178		
<b>Sportage SL</b>		8/10-on	4 Cyl 2.0L D4HA
Water Pump	TF8493		
<b>Sportage SL</b>		8/10-on	4 Cyl 2.4L G4KE
Water Pump	TF8498	Pump without Housing & Pulley	
Water Pump	TF8498H	Pump with Housing & Pulley	
<b>Sportage SL</b>		8/10-on	4 Cyl 2.0L G4KD
Water Pump	TF8498	Pump without Housing & Pulley	
Water Pump	TF8498H	Pump with Housing & Pulley	

Description	Part No	Year & Notes	Engine
<b>LANDROVER</b>			
<b>Series 2, 2A, 3</b>		<b>1961-12/80</b>	<b>4 Cyl 2.3L</b>
Water Pump	<b>TF216</b>		
<b>Defender Ohv, Turbo Diesel</b>		<b>1/93-10/07</b>	<b>4 Cyl 2.5L 18L</b>
Water Pump	<b>TF8198</b>	<i>To 12/94</i>	
Water Pump	<b>TF8199</b>	<i>From 1/95</i>	
<b>Defender Ohc, Turbo Diesel</b>		<b>12/94-10/07</b>	<b>5 Cyl 2.5L 10P, 15P</b>
Water Pump	<b>TF8370</b>	<i>To Engine No. 15P28909A with RH Chamber Hole</i>	
Water Pump	<b>TF8230</b>	<i>From Engine No. 15P28910A with LH Chamber Hole</i>	
<b>Discovery Ohv, Turbo Diesel</b>		<b>4/92-2/99</b>	<b>4 Cyl 2.5L 18L, 20L</b>
Water Pump	<b>TF8198</b>	<i>To 12/94</i>	
Water Pump	<b>TF8199</b>	<i>From 1/95</i>	
<b>Discovery Sohc, Turbo Diesel</b>		<b>2/99-11/04</b>	<b>5 Cyl 2.5L 10P, 160P</b>
Water Pump	<b>TF8370</b>	<i>To Engine No. 15P28909A with RH Chamber Hole</i>	
Water Pump	<b>TF8230</b>	<i>From Engine No. 15P28910A with LH Chamber Hole</i>	
<b>Discovery Turbo Diesel</b>		<b>11/04-on</b>	<b>V6 2.7L ELD11</b>
Water Pump	<b>TF8410</b>		
<b>Discovery</b>		<b>11/04-on</b>	<b>V6 4.0L 582</b>
Water Pump	<b>TF4103</b>		
<b>Discovery</b>		<b>3/91-4/94</b>	<b>V8 3.5L 22D</b>
Water Pump	<b>TF2614</b>		
<b>Discovery</b>		<b>3/91-2/99</b>	<b>V8 3.9L 37D, 38D</b>
Water Pump	<b>TF2614</b>	<i>To Vin No. LA081990</i>	
<b>Discovery EFi</b>		<b>3/91-2/99</b>	<b>V8 3.9L 37D, 38D</b>
Water Pump	<b>TF8271</b>	<i>From Vin no. MAA081991</i>	
<b>Discovery EFi</b>		<b>2/99-3/05</b>	<b>V8 4.0L 55D</b>
Water Pump	<b>TF8271</b>		
Thermostat & Housing	<b>TTH572</b>		
Radiator Fan Blade	<b>TFB549</b>		
<b>Freelander</b>		<b>2/98-11/00</b>	<b>4 Cyl 1.8L 18K</b>
Water Pump	<b>TF8182</b>		
<b>Freelander Sohc</b>		<b>2/98-1/07</b>	<b>4 Cyl 2.0L L, M47</b>
Water Pump	<b>TF8398</b>		

Description	Part No	Year & Notes	Engine
<b>LANDROVER</b>			
<b>Freelander Dohc</b>		11/00-2/04	V6 2.5L 25K4F
<i>Water Pump</i>	<b>TF8256</b>		
<b>Range Rover Sport Turbo Diesel</b>		8/05-1/09	V6 2.7L ELD11
<i>Water Pump</i>	<b>TF8410</b>		
<b>Range Rover Turbo Diesel</b>		8/02-1/07	6 Cyl 2.9L TD6
<i>Water Pump</i>	<b>TF8381</b>		
<b>Range Rover Turbo Diesel</b>		8/02-on	6 Cyl 3.0L 306DT
<i>Water Pump</i>	<b>TF8381</b>		
<b>Range Rover Petrol</b>		2/86-1/89	V8 3.5L 22D
<i>Water Pump</i>	<b>TF2614</b>		
<b>Range Rover Petrol</b>		1/90-1/92	V8 3.9L 37D, 38D
<i>Water Pump</i>	<b>TF2614</b>		
<b>Range Rover Petrol</b>		1/93-1/95	V8 3.9L 37D, 38D
<i>Water Pump</i>	<b>TF8271</b>		
<b>Range Rover Petrol</b>		5/95-1/03	V8 4.0L 44D
<i>Water Pump</i>	<b>TF8271</b>		
<b>Range Rover L322, Vogue Petrol</b>		8/02-9/09	V8 4.4L
<i>Water Pump</i>	<b>TF8258</b>		
<b>Range Rover Petrol</b>		5/95-1/02	V8 4.6L 48D, 59D
<i>Water Pump</i>	<b>TF8271</b>		
<b>LOTUS</b>			
<b>Elise, Exige Dohc</b>		1/04-on	4 Cyl 1.8L 2ZZGE
<i>Water Pump</i>	<b>TF8228</b>		
<b>LEXUS</b>			
<b>ES300 VCV10R</b>		6/92-10/96	V6 3.0L 3VZFE
<i>Water Pump</i>	<b>TF3040</b>		
<b>ES300 MCV10</b>		10/96-11/05	V6 3.0L 1MZFE
<i>Water Pump</i>	<b>TF9092</b>		
<i>Timing Belt Kit</i>	<b>TFK100H</b>	<i>Kit contains Hydraulic Tensioner</i>	

Description	Part No	Year & Notes	Engine
<b>LEXUS</b>			
<b>ES300 MCV20, MCV30</b>		<b>10/96-11/05</b>	<b>V6 3.0L 1MZFE</b>
Water Pump	<b>TF9092</b>		
Timing Belt Kit	<b>TFK100H1</b>	<i>Kit contains Hydraulic Tensioner</i>	
<b>GS300 JZS160</b>		<b>11/97-3/05</b>	<b>6 Cyl 3.0L 2JZGE</b>
Water Pump	<b>TF8141</b>	<i>Pump without Housing 64mm Hub</i>	
Water Pump	<b>TF8141H</b>	<i>Pump with Housing 64mm Hub</i>	
<b>GS300 GRS190</b>		<b>3/05-on</b>	<b>V6 3.0L 3GRFSE</b>
Water Pump	<b>TF8229</b>		
<b>GS430 UZS190</b>		<b>3/05-3/09</b>	<b>V8 4.3L 3UZFE</b>
Water Pump	<b>TF8143</b>		
<b>GS450H GWS191</b>		<b>5/06-on</b>	<b>V6 3.5L 2GRFSE</b>
Water Pump	<b>TF8229</b>		
<b>GS460</b>		<b>3/08-on</b>	<b>V8 4.6L 1URFSE</b>
Water Pump	<b>TF8446</b>	<i>From 4/10</i>	
Thermostat & Housing	<b>TTH564</b>		
<b>iS200 GXE10</b>		<b>3/99-10/05</b>	<b>6 Cyl 2.0L 1GFE</b>
Water Pump	<b>TF8148</b>		
<b>iS250 GSE20</b>		<b>11/05-on</b>	<b>V6 2.5L 4GRFSE</b>
Water Pump	<b>TF8229</b>		
<b>iS300 JCE10</b>		<b>8/01-10/05</b>	<b>6 Cyl 3.0L 2JZ</b>
Water Pump	<b>TF8141</b>	<i>Pump without Housing 64mm Hub</i>	
Water Pump	<b>TF8141H</b>	<i>Pump with Housing 64mm Hub</i>	
<b>LS400 UCF10R</b>		<b>5/90-10/94</b>	<b>V8 4.0L 1UZFE</b>
Water Pump	<b>TF3104</b>		
Water Pump Fan Bracket	<b>TF3104FB</b>		
<b>LS400 UCF20R</b>		<b>12/94-11/00</b>	<b>V8 4.0L 1UZFE</b>
Water Pump	<b>TF3104</b>	<i>To 7/97</i>	
Water Pump	<b>TF8143</b>	<i>From 8/97</i>	
Water Pump Fan Bracket	<b>TF3104FB</b>	<i>To 7/97</i>	
Water Pump Fan Bracket	<b>TF8143FB</b>	<i>From 8/97</i>	
<b>LS430 UCF30R</b>		<b>11/00-4/08</b>	<b>V8 4.3L 3UZFE</b>
Water Pump	<b>TF8143</b>		

Description	Part No	Year & Notes	Engine
<b>LEXUS</b>			
<b>LX470 UZJ100</b>		<b>5/98-4/08</b>	<b>V8 4.7L 2UZFE</b>
Water Pump	<b>TF8143</b>		
Water Pump Fan Bracket	<b>TF8143FB</b>		
Radiator Fan Blade	<b>TFB506</b>		
<b>LX570</b>		<b>4/08-on</b>	<b>V8 5.7L 3URFE</b>
Water Pump	<b>TF8433</b>		
Thermostat & Housing	<b>TTH564</b>		
Fan Clutch	<b>TFC236</b>		
<b>RX330 MCU38</b>		<b>4/03-1/06</b>	<b>V6 3.4L 3MZFE</b>
Water Pump	<b>TF9092</b>		
<b>RX350 GSU35</b>		<b>2/06-on</b>	<b>V6 3.5L 2GRFE</b>
Water Pump	<b>TF8253</b>		
<b>RX400 W31</b>		<b>6/06-on</b>	<b>6 Cyl 3.3L 3MZFE</b>
Water Pump	<b>TF9092</b>		
<b>SC430 UZZ40</b>		<b>10/01-on</b>	<b>V8 4.3L 3UZFE</b>
Water Pump	<b>TF8143</b>		
<b>MAZDA</b>			
<b>Mazda 2 DY</b>		<b>12/02-9/07</b>	<b>4 Cyl 1.5L ZY</b>
Water Pump	<b>TF8262</b>		
<b>Mazda 2 DE</b>		<b>9/07-on</b>	<b>4 Cyl 1.5L ZY</b>
Water Pump	<b>TF8262</b>		
<b>Mazda 3 BK</b>		<b>1/04-on</b>	<b>4 Cyl 2.0L LF</b>
Water Pump	<b>TF8265</b>		
Timing Chain Kit	<b>TCK105</b>	<i>To 7/06 Without VVT</i>	
Timing Chain Kit	<b>TCK104</b>	<i>From 7/06 with VVT</i>	
<b>Mazda 3 BK Turbo Diesel</b>		<b>8/07-4/09</b>	<b>4 Cyl 2.0L MZR-CD</b>
Water Pump	<b>TF8376</b>		
<b>Mazda 3 BK</b>		<b>6/03-on</b>	<b>4 Cyl 2.3L L3</b>
Water Pump	<b>TF8265</b>		
Thermostat & Housing	<b>TTH578</b>		



Description	Part No	Year & Notes	Engine
<b>MAZDA</b>			
<b>Mazda 3 BL</b>		<b>4/09-on</b>	<b>4 Cyl 2.5L L5</b>
Water Pump	<b>TF8265</b>		
Thermostat & Housing	<b>TTH578</b>		
<b>Mazda 3 SP25</b>		<b>4/09-on</b>	<b>4 Cyl 2.5L L5</b>
Water Pump	<b>TF8265</b>		
Thermostat & Housing	<b>TTH578</b>		
<b>Mazda 6 GG, GY Turbo Diesel</b>		<b>10/06-2/08</b>	<b>4 Cyl 2.0L MZR-CD</b>
Water Pump	<b>TF8376</b>		
<b>Mazda 6 GG, GY incl. Turbo</b>		<b>8/02-2/08</b>	<b>4 Cyl 2.3L L3</b>
Water Pump	<b>TF8265</b>		
Timing Chain Kit	<b>TCK103</b>		
<b>Mazda 6 GH</b>		<b>2/08-on</b>	<b>4 Cyl 2.5L L5</b>
Water Pump	<b>TF8265</b>		
Thermostat & Housing	<b>TTH578</b>		
<b>121</b>		<b>3/76-3/79</b>	<b>4 Cyl 1.8L VC</b>
Water Pump	<b>TF824</b>		
<b>121</b>		<b>4/78-12/80</b>	<b>4 Cyl 2.0L MA</b>
Water Pump	<b>TF756</b>		
<b>121</b>		<b>3/87-12/02</b>	<b>4 Cyl 1.3L B3</b>
Water Pump	<b>TF1020</b>		
Timing Belt Kit	<b>TFK049</b>	<i>To 11/90</i>	
Timing Belt Kit	<b>TFK049</b>	<i>From 12/90</i>	
Timing Belt Kit with Water Pump	<b>TFK048P</b>	<i>To 11/90</i>	
Timing Belt Kit with Water Pump	<b>TFK049P</b>	<i>From 12/90</i>	
<b>121</b>		<b>1/94-10/96</b>	<b>4 Cyl 1.5L B5</b>
Water Pump	<b>TF1020</b>		
Timing Belt Kit	<b>TFK019</b>		
Timing Belt Kit with Water Pump	<b>TFK049P</b>	<i>Kit contains TF1020 Pump</i>	
<b>323</b>		<b>3/77-12/81</b>	<b>4 Cyl 1.3L, 1.4L TC, UC</b>
Water Pump	<b>TF2051</b>		
<b>323 BD</b>		<b>10/80-10/85</b>	<b>4 Cyl 1.3L, 1.5L E3, E5</b>
Water Pump	<b>TF817</b>		
Timing Belt Kit	<b>TFK048</b>	<i>Kit contains 107 Teeth x 21mm wide Timing Belt</i>	
Timing Belt Kit	<b>TFK049</b>	<i>Kit contains 107 Teeth x 22mm wide Timing Belt</i>	

Description	Part No	Year & Notes	Engine
<b>MAZDA</b>			
<b>323 BF</b>			
		<b>10/85-10/89</b>	<b>4 Cyl 1.6L B6, B6T</b>
Water Pump	<b>TF1020</b>	<i>Suits Non Turbo Model</i>	
Water Pump	<b>TF3010</b>	<i>Suits Turbo Model</i>	
Timing Belt Kit	<b>TFK048</b>	<i>Kit contains 107 Teeth x 21mm wide Timing Belt</i>	
Timing Belt Kit	<b>TFK049</b>	<i>Kit contains 107 Teeth x 22mm wide Timing Belt</i>	
Timing Belt Kit with Water Pump	<b>TFK049P</b>	<i>Kit contains 107 Teeth x 22mm wide Timing Belt &amp; TF1020 Pump</i>	
<b>323 BA, BG Sohc</b>			
		<b>10/89-8/98</b>	<b>4 Cyl 1.6L B6</b>
Water Pump	<b>TF1020</b>	<i>To 8/94</i>	
Timing Belt Kit	<b>TFK049</b>	<i>Kit contains 107 Teeth x 22mm wide Timing Belt</i>	
Timing Belt Kit with Water Pump	<b>TFK049P</b>	<i>Kit contains 107 Teeth x 22mm wide Timing Belt &amp; TF1020 Pump</i>	
<b>323 BA, BG Dohc</b>			
		<b>9/94-9/98</b>	<b>4 Cyl 1.6L B6</b>
Water Pump	<b>TF3081</b>		
Timing Belt Kit	<b>TFK050</b>		
Timing Belt Kit with Water Pump	<b>TFK050P</b>	<i>Kit contains TF3081 Pump</i>	
<b>323 Astina, Protégé BJ</b>			
		<b>9/98-5/02</b>	<b>4 Cyl 1.6L ZM, ZMD</b>
Water Pump	<b>TF3081</b>		
Timing Belt Kit	<b>TFK112</b>		
Timing Belt Kit with Water Pump	<b>TFK112P</b>	<i>Kit contains TF3081 Pump</i>	
<b>323 BA, BG Sohc</b>			
		<b>10/89-8/94</b>	<b>4 Cyl 1.8L BP</b>
Water Pump	<b>TF1020</b>		
<b>323 BA, BG Dohc</b>			
		<b>10/89-9/98</b>	<b>4 Cyl 1.8L BP</b>
Water Pump	<b>TF3010</b>	<i>To 8/94</i>	
Water Pump	<b>TF3081</b>	<i>From 9/94</i>	
<b>323 Astina, Protégé BJ</b>			
		<b>9/98-5/02</b>	<b>4 Cyl 1.8L FP</b>
Water Pump	<b>TF3082</b>	<i>Pump without Housing</i>	
Timing Belt Kit	<b>TFK155</b>		
Timing Belt Kit with Water Pump	<b>TFK155P</b>	<i>Kit contains TF3082 Pump</i>	
<b>323 BA</b>			
		<b>7/94-9/98</b>	<b>V6 2.0L KF</b>
Water Pump	<b>TF3076</b>		
Timing Belt Kit	<b>TFK041</b>		
<b>323 Astina, Protégé BJ</b>			
		<b>2/01-12/03</b>	<b>4 Cyl 2.0L FSD</b>
Water Pump	<b>TF3082</b>	<i>Pump without Housing</i>	
<b>626 GB</b>			
		<b>12/78-2/83</b>	<b>4 Cyl 2.0L MA</b>
Water Pump	<b>TF756</b>		

Description	Part No	Year & Notes	Engine
<b>MAZDA</b>			
<b>626 GC incl. Turbo</b>		<b>2/83-10/87</b>	<b>4 Cyl 2.0L FE</b>
Water Pump	<b>TF893</b>	<i>Suits Round Tooth Timing Belt 22mm Wide</i>	
Water Pump	<b>TF895</b>	<i>Suits Square Tooth Timing Belt 19mm Wide</i>	
<b>626 GD incl. Turbo</b>		<b>10/87-12/91</b>	<b>4 Cyl 2.2L F2</b>
Water Pump	<b>TF2032</b>		
Timing Belt Kit	<b>TFK051</b>		
<b>626 GE</b>		<b>1/92-6/97</b>	<b>4 Cyl 2.0L FS</b>
Water Pump	<b>TF3082</b>	<i>Pump without Housing</i>	
Timing Belt Kit	<b>TFK045</b>		
Timing Belt Kit with Water Pump	<b>TFK045P</b>	<i>Kit contains TF3082 Pump</i>	
<b>626 GE</b>		<b>1/92-6/97</b>	<b>V6 2.5L KL</b>
Water Pump	<b>TF3075</b>	<i>To Chassis No. 0100608 with Round Flat Hub</i>	
Water Pump	<b>TF3076</b>	<i>From Chassis No 0100609 with Stepped Star Hub</i>	
Timing Belt Kit	<b>TFK041</b>		
<b>626 GF</b>		<b>7/97-8/02</b>	<b>4 Cyl 2.0L FSD</b>
Water Pump	<b>TF3082</b>	<i>Pump without Housing</i>	
<b>808</b>		<b>1972-78</b>	<b>4 Cyl 1.3L TC</b>
Water Pump	<b>TF2051</b>		
<b>808</b>		<b>1977-78</b>	<b>4 Cyl 1.6L NA</b>
Water Pump	<b>TF824</b>		
<b>929 LA</b>		<b>8/73-6/79</b>	<b>4 Cyl 1.8L VC</b>
Water Pump	<b>TF824</b>		
<b>929 LA, HB</b>		<b>6/78-12/83</b>	<b>4 Cyl 2.0L MA</b>
Water Pump	<b>TF756</b>		
Fan Clutch	<b>TFC162</b>		
<b>929 HB incl. Turbo</b>		<b>2/84-6/87</b>	<b>4 Cyl 2.0L FE</b>
Water Pump	<b>TF893</b>	<i>Suits Round Tooth Timing Belt 22mm Wide</i>	
Water Pump	<b>TF895</b>	<i>Suits Square Tooth Timing Belt 19mm Wide</i>	
Fan Clutch	<b>TFC194</b>		
<b>929 HC10E1 Sohc</b>		<b>7/87-12/89</b>	<b>V6 3.0L JE</b>
Water Pump	<b>TF3015</b>	<i>17mm Shaft 11.5mm length from Hub</i>	
<b>929 HC10E2 Sohc</b>		<b>1/90-8/91</b>	<b>V6 3.0L JE42</b>
Water Pump	<b>TF3015</b>	<i>17mm Shaft 11.5mm length from Hub</i>	

Description	Part No	Year & Notes	Engine
<b>MAZDA</b>			
<b>929 HC10E2 Dohc</b>		<b>8/91-1/94</b>	<b>V6 3.0L JE41</b>
<i>Water Pump</i>	<b>TF4016</b>		
<b>929 HD10E1 Dohc</b>		<b>1/94-3/96</b>	<b>V6 3.0L JE55</b>
<i>Water Pump</i>	<b>TF4016</b>		
<b>929 HE10E1 Dohc</b>		<b>4/96-11/97</b>	<b>V6 3.0L JEZE</b>
<i>Water Pump</i>	<b>TF4016</b>		
<b>1300</b>		<b>7/70-2/77</b>	<b>4 Cyl 1.3L TC</b>
<i>Water Pump</i>	<b>TF2051</b>		
<b>1500</b>		<b>10/66-9/69</b>	<b>4 Cyl 1.5L UB</b>
<i>Water Pump</i>	<b>TF824</b>		
<b>1600</b>		<b>6/77-12/78</b>	<b>4 Cyl 1.6L NA</b>
<i>Water Pump</i>	<b>TF824</b>		
<b>1800</b>		<b>9/69-7/73</b>	<b>4 Cyl 1.8L VB</b>
<i>Water Pump</i>	<b>TF756</b>		
<b>B1500, B1600, B1800</b>		<b>1/70-11/82</b>	<b>4 Cyl 1.5L, 1.6L, 1.8L UB, NA, VC</b>
<i>Water Pump</i>	<b>TF824</b>		
<b>B2000</b>		<b>12/82-5/85</b>	<b>4 Cyl 2.0L MA</b>
<i>Water Pump</i>	<b>TF756</b>		
<i>Fan Clutch</i>	<b>TFC194</b>		
<b>B2000</b>		<b>6/85-7/88</b>	<b>4 Cyl 2.0L FE</b>
<i>Water Pump</i>	<b>TF893</b>	<i>To 4/87 With Round Tooth Timing Belt 22mm</i>	
<i>Water Pump</i>	<b>TF895</b>	<i>To 4/87 With Square Tooth Timing Belt 19mm</i>	
<i>Water Pump</i>	<b>TF2032</b>	<i>From 4/87</i>	
<i>Fan Clutch</i>	<b>TFC194</b>	<i>All</i>	
<b>B2200</b>		<b>3/88-2/93</b>	<b>4 Cyl 2.2L F2</b>
<i>Water Pump</i>	<b>TF2032</b>		
<i>Fan Clutch</i>	<b>TFC194</b>		
<i>Timing Belt Kit</i>	<b>TFK051</b>		
<b>B2200 Diesel Ohv</b>		<b>1/81-5/85</b>	<b>4 Cyl 2.2L S2</b>
<i>Water Pump</i>	<b>TF1028</b>		

Description	Part No	Year & Notes	Engine
<b>MAZDA</b>			
<b>B2200 Diesel Ohv</b>		1/86-1/92	4 Cyl 2.2L R2
Water Pump	TF1018		
Fan Clutch	TFC193		
<b>B2500 Bravo Diesel</b>		4/96-2/99	4 Cyl 2.5L WL
Water Pump	TF4059		
Fan Clutch	TFC154		
Radiator Fan Blade	TFB529		
Timing Belt Kit	TFK192		
<b>B2500 Bravo Turbo Diesel</b>		3/99-11/06	4 Cyl 2.5L WLT
Water Pump	TF4059		
Fan Clutch	TFC154		
Radiator Fan Blade	TFB546		
Timing Belt Kit	TFK193		
<b>B2600</b>		3/87-10/91	4 Cyl 2.6L 4G54
Water Pump	TF1009		
Fan Clutch	TFC117		
<b>B2600 Bravo</b>		12/90-7/06	4 Cyl 2.6L G6, G6E
Water Pump	TF3123		
Fan Clutch	TFC114		
<b>B4000 Bravo</b>		1/05-7/08	V6 4.0L 13V
Water Pump	TF4103		
Fan Clutch	TFC217		
Timing Chain Kit	TCK116G	<i>Suits Manual Transmission Models (kit with Gears)</i>	
<b>BT-50 Turbo Diesel</b>		11/06-on	4 Cyl 2.5L, 3.0L WLAT, WEAT
Water Pump	TF4059		
Fan Clutch	TFC234		
Radiator Fan Blade	TFB529		
<b>Capella</b>		10/70-12/78	4 Cyl 1.6L NA
Water Pump	TF824		
<b>CX7 ER</b>		10/06-on	4 Cyl 2.3L L3
Water Pump	TF8265		
Thermostat & Housing	TTH578		
<b>CX7</b>		10/09-on	4 Cyl 2.5L MZR
Water Pump	TF8265		
Thermostat & Housing	TTH578		



Description	Part No	Year & Notes	Engine
<b>MAZDA</b>			
<b>E1300</b>		<b>5/78-1/80</b>	<b>4 Cyl 1.3L TC</b>
Water Pump	<b>TF2051</b>		
<b>E1400</b>		<b>5/78-12/83</b>	<b>4 Cyl 1.4L UC</b>
Water Pump	<b>TF2051</b>		
<b>E1600</b>		<b>5/78-12/83</b>	<b>4 Cyl 1.6L NA</b>
Water Pump	<b>TF824</b>		
<b>E1800</b>		<b>2/84-7/06</b>	<b>4 Cyl 1.8L F8</b>
Water Pump	<b>TF893</b>	<i>To 4/87 With Round Tooth Timing Belt 22mm</i>	
Water Pump	<b>TF895</b>	<i>To 4/87 With Square Tooth Timing Belt 19mm</i>	
Water Pump	<b>TF2032</b>	<i>From 4/87</i>	
Fan Clutch	<b>TFC162</b>	<i>All</i>	
<b>E2000</b>		<b>2/84-7/06</b>	<b>4 Cyl 2.0L FE</b>
Water Pump	<b>TF893</b>	<i>To 4/87 With Round Tooth Timing Belt 22mm</i>	
Water Pump	<b>TF895</b>	<i>To 4/87 With Square Tooth Timing Belt 19mm</i>	
Water Pump	<b>TF2032</b>	<i>From 4/87</i>	
Fan Clutch	<b>TFC162</b>	<i>All</i>	
Radiator Fan Blade	<b>TFB538</b>	<i>To 1/03 7 Blade</i>	
Timing Belt Kit	<b>TFK052</b>	<i>Kit contains Round Tooth Timing Belt</i>	
<b>E2200 Diesel Ohv</b>		<b>5/81-1/84</b>	<b>4 Cyl 2.2L S2</b>
Water Pump	<b>TF1028</b>		
<b>E2200 Diesel Ohc</b>		<b>2/84-8/97</b>	<b>4 Cyl 2.2L R2</b>
Water Pump	<b>TF1018</b>		
Fan Clutch	<b>TFC193</b>		
<b>E2500 Diesel</b>		<b>8/97-5/03</b>	<b>4 Cyl 2.5L WL</b>
Water Pump	<b>TF4059</b>		
Fan Clutch	<b>TFC154</b>		
Radiator Fan Blade	<b>TFB529</b>		
Timing Belt Kit	<b>TFK192</b>		
<b>Eunos 30X</b>		<b>6/96-10/97</b>	<b>V6 1.8L K8</b>
Water Pump	<b>TF3075</b>	<i>To Chassis No. 0109609 with Round Flat Hub</i>	
Water Pump	<b>TF3076</b>	<i>From Chassis No 019610 with Stepped Star Hub</i>	
Timing Belt Kit	<b>TFK041</b>		

Description	Part No	Year & Notes	Engine
<b>MAZDA</b>			
<b>Eunos 500</b>			
		<b>6/96-9/99</b>	<b>V6 2.0L KF</b>
Water Pump	<b>TF3075</b>	<i>To Chassis No. 0114350 with Round Flat Hub</i>	
Water Pump	<b>TF3076</b>	<i>From Chassis No 0114351 with Stepped Star Hub</i>	
Timing Belt Kit	<b>TFK041</b>		
<b>Eunos 800</b>			
		<b>6/96-10/98</b>	<b>V6 2.5L KL</b>
Water Pump	<b>TF3076</b>		
Timing Belt Kit	<b>TFK041</b>		
<b>MPV LW</b>			
		<b>8/99-6/02</b>	<b>V6 2.5L GY</b>
Water Pump	<b>TF8183</b>	<i>To 7/03 Pump without Housing 37mm from bottom face of Pump to end of impeller (Steel)</i>	
Water Pump	<b>TF8183H</b>	<i>To 7/03 Pump with Housing (38mm Outlet)</i>	
Water Pump	<b>TF8323</b>	<i>From 7/03 Pump without Housing 36mm from bottom face of Pump to end of impeller (Plastic)</i>	
Water Pump	<b>TF8323H</b>	<i>From 7/03 Pump with Housing (30mm Outlet)</i>	
<b>MPV LV</b>			
		<b>10/93-8/99</b>	<b>V6 3.0L JE</b>
Water Pump	<b>TF3015</b>	<i>To 11/95 17mm Shaft</i>	
Water Pump	<b>TF3032</b>	<i>From 12/95 19mm Shaft</i>	
<b>MPV LW</b>			
		<b>6/02-11/06</b>	<b>V6 3.0L AJ</b>
Water Pump	<b>TF8183</b>	<i>To 7/03 Pump without Housing 37mm from bottom face of Pump to end of impeller (Steel)</i>	
Water Pump	<b>TF8183H</b>	<i>To 7/03 Pump with Housing (38mm Outlet)</i>	
Water Pump	<b>TF8323</b>	<i>From 7/03 Pump without Housing 36mm from bottom face of Pump to end of impeller (Plastic)</i>	
Water Pump	<b>TF8323H</b>	<i>From 7/03 Pump with Housing (30mm Outlet)</i>	
<b>MX5</b>			
		<b>10/89-11/93</b>	<b>4 Cyl 1.6L B6</b>
Water Pump	<b>TF3010</b>		
Timing Belt Kit	<b>TFK050</b>	<i>Kit contains 145 Teeth x 22mm wide Timing Belt</i>	
<b>MX5 incl. Turbo</b>			
		<b>11/93-8/05</b>	<b>4 Cyl 1.8L BP</b>
Water Pump	<b>TF3081</b>		
Timing Belt Kit	<b>TFK050</b>	<i>Kit contains 145 Teeth x 22mm wide Timing Belt</i>	
Timing Belt Kit with Water Pump	<b>TFK050P</b>	<i>Kit contains TF3081 Pump</i>	
<b>MX5</b>			
		<b>9/05-on</b>	<b>4 Cyl 2.0L LF</b>
Water Pump	<b>TF8265</b>		
<b>MX6 Turbo</b>			
		<b>10/87-10/91</b>	<b>4 Cyl 2.2L F2</b>
Water Pump	<b>TF2032</b>		
Timing Belt Kit	<b>TFK051</b>		

Description	Part No	Year & Notes	Engine
<b>MAZDA</b>			
<b>MX6</b>			
		11/91-12/97	V6 2.5L KL
Water Pump	TF3075	To 7/93 To Vin No.3701 with Round Flat Hub	
Water Pump	TF3076	From 7/93 From Vin No. 3701 with Stepped Star Hub	
Timing Belt Kit	TFK041		
<b>Premacy CP</b>			
		2/01-6/03	4 Cyl 1.8L FP
Water Pump	TF3082	Pump without Housing	
Timing Belt Kit	TFK155		
Timing Belt Kit with Water Pump	TFK155P	Kit contains TF3082 Pump	
<b>Premacy CP</b>			
		2/01-6/03	4 Cyl 2.0L FS
Water Pump	TF3082	Pump without Housing	
Timing Belt Kit	TFK045		
Timing Belt Kit with Water Pump	TFK045P	Kit contains TF3082 Pump	
<b>RX2, RX3, RX4, RX5</b>			
		10/70-6/79	Rotary 1.1L, 1.3L 12A, 13B
Water Pump	TF851		
<b>RX7 Series 1, 2, 3</b>			
		3/79-12/85	Rotary 1.1L 12A
Water Pump	TF851		
<b>RX7 Series 4 Turbo</b>			
		1/86-2/89	Rotary 1.3L 13B
Water Pump	TF8282	Auto Transmission 17mm shaft & 8mm high	
<b>RX7 Series 5 Incl. Turbo</b>			
		3/89-12/91	Rotary 1.3L 13B
Water Pump	TF8178	19mm shaft	
<b>RX7 Series 6, 7, 8 Twin Turbo</b>			
		1/92-2/99	Rotary 1.3L 13B
Water Pump	TF8177	16mm shaft 3mm high	
<b>RX8</b>			
		7/03-on	Rotary 1.3L 13B
Water Pump	TF8367		
<b>T2600</b>			
		4/85-12/88	4 Cyl 2.6L 4G54
Water Pump	TF1009		
Fan Clutch	TFC117		
<b>T3000</b>			
		1/84-10/84	4 Cyl 3.0L HA
Water Pump	TF1150		
<b>T3500 incl. Turbo</b>			
		5/84-4/97	4 Cyl 3.5L SL, SLT
Water Pump	TF3013		
Fan Clutch	TFC158		

Description	Part No	Year & Notes	Engine
<b>MAZDA</b>			
<b>T4000</b>		<b>11/89-on</b>	<b>4 Cyl 4.0L TF</b>
Water Pump	<b>TF8179</b>		
Fan Clutch	<b>TFC163</b>		
<b>T4100</b>		<b>1/84-12/91</b>	<b>6 Cyl 4.1L ZB</b>
Water Pump	<b>TF3014</b>		
Fan Clutch	<b>TFC159</b>		
<b>T4600</b>		<b>6/92-6/03</b>	<b>4 Cyl 4.6L TM</b>
Water Pump	<b>TF8179</b>		
Fan Clutch	<b>TFC163</b>		
<b>Traveller</b>		<b>1/83-12/83</b>	<b>4 Cyl 1.4L UC</b>
Water Pump	<b>TF2051</b>		
<b>Traveller</b>		<b>1/83-5/84</b>	<b>4 Cyl 1.6L NA</b>
Water Pump	<b>TF824</b>		
<b>Traveller</b>		<b>6/84-12/87</b>	<b>4 Cyl 1.8L F8</b>
Water Pump	<b>TF893</b>	<i>Suits Round Tooth Timing Belt 22mm Wide</i>	
Water Pump	<b>TF895</b>	<i>Suits Square Tooth Timing Belt 19mm Wide</i>	
<b>Traveller</b>		<b>8/86-3/88</b>	<b>4 Cyl 2.0L FE</b>
Water Pump	<b>TF2032</b>		
Fan Clutch	<b>TFC120</b>		
<b>Tribute</b>		<b>2/01-1/04</b>	<b>4 Cyl 2.0L YF</b>
Water Pump	<b>TF8181</b>		
<b>Tribute</b>		<b>1/04-12/07</b>	<b>4 Cyl 2.3L L3</b>
Water Pump	<b>TF8265</b>		
Thermostat & Housing	<b>TTH578</b>		
<b>Tribute</b>		<b>2/01-1/04</b>	<b>V6 3.0L AJ</b>
Water Pump	<b>TF8183</b>	<i>To 7/03 Pump without Housing 37mm from bottom face of Pump to end of impeller (Steel)</i>	
Water Pump	<b>TF8183H</b>	<i>To 7/03 Pump with Housing (38mm Outlet)</i>	
Water Pump	<b>TF8323</b>	<i>From 7/03 Pump without Housing 36mm from bottom face of Pump to end of impeller (Plastic)</i>	
Water Pump	<b>TF8323H</b>	<i>From 7/03 Pump with Housing (30mm Outlet)</i>	

Description	Part No	Year & Notes	Engine
<b>MERCEDES BENZ</b>			
<b>180E W201</b>		10/91-3/94	4 Cyl 1.8L M102.910
Water Pump	TF1408		
<b>190D W201 Diesel</b>		1/86-12/89	5 Cyl 2.5L M602.911
Water Pump	TF8121		
<b>190E W201</b>		9/90-12/994	4 Cyl 1.8L M102.910
Water Pump	TF1408		
<b>190E W201</b>		12/84-1/95	4 Cyl 2.0L M102.962
Water Pump	TF2354	To 1989	
Water Pump	TF1408	From 1989	
<b>190E W201</b>		7/87-10/92	4 Cyl 2.3L, 2.6L M102.985, M103.942
Water Pump	TF1408		
<b>220, 220D C115</b>		1968-73	4 Cyl 2.0L, 2.8L
Water Pump	TF995		
<b>220E W124</b>		3/93-8/93	4 Cyl 2.2L M111.960
Water Pump	TF4035		
Thermostat & Housing	TTH574		
<b>230 C114</b>		1968-73	4 Cyl 2.3L
Water Pump	TF995		
<b>230E W123</b>		7/81-12/85	4 Cyl 2.3L M102.980
Water Pump	TF2354		
<b>230E W124</b>		1/86-2/93	4 Cyl 2.3L M102.982
Water Pump	TF1408		
<b>230GE, 230TE W123, W124</b>		12/83-4/89	4 Cyl 2.3L M102.982
Water Pump	TF1408		
<b>240D, 250, 250C C114, C115</b>		9/72-12/82	4 Cyl 2.4L, 2.8L
Water Pump	TF995		
<b>260E W124</b>		8/88-3/91	6 Cyl 2.6L M103.94
Water Pump	TF8114		
<b>280C, 280CE, 280S</b>		10/72-12/76	6 Cyl 2.8L
Water Pump	TF995		



Description	Part No	Year & Notes	Engine
<b>MERCEDES BENZ</b>			
<b>300CE C124</b>		<b>2/88-2/93</b>	<b>6 Cyl 3.0L</b>
<i>Water Pump</i>	<b>TF8114</b>		
<b>300D W123 Diesel</b>		<b>11/76-12/85</b>	<b>5 Cyl 3.0L</b>
<i>Water Pump</i>	<b>TF995</b>	<i>To 8/79</i>	
<i>Water Pump</i>	<b>TF8121</b>	<i>From 9/79</i>	
<b>300D W124 Diesel</b>		<b>2/86-9/93</b>	<b>6 Cyl 3.0L M603.912</b>
<i>Water Pump</i>	<b>TF8114</b>		
<b>300E W124 Petrol</b>		<b>3/86-2/93</b>	<b>6 Cyl 3.0L M104.98</b>
<i>Water Pump</i>	<b>TF8114</b>		
<b>300SEL W124, W126</b>		<b>3/87-3/93</b>	<b>6 Cyl 3.0L M103.981</b>
<i>Water Pump</i>	<b>TF8114</b>		
<b>400SE, 400SEL W140</b>		<b>3/92-8/93</b>	<b>V8 4.2L M119.971</b>
<i>Water Pump</i>	<b>TF8238</b>		
<b>A150 W169</b>		<b>4/05-7/07</b>	<b>4 Cyl 1.5L M266.920</b>
<i>Water Pump</i>	<b>TF8463</b>		
<b>A170, A180 W169</b>		<b>4/05-12/09</b>	<b>4 Cyl 1.7L M266.940</b>
<i>Water Pump</i>	<b>TF8463</b>		
<b>A200 W169</b>		<b>4/05-12/09</b>	<b>4 Cyl 2.0L M266.960</b>
<i>Water Pump</i>	<b>TF8463</b>		
<b>B180 W245 Turbo Diesel</b>		<b>2/06-on</b>	<b>4 Cyl 2.0L M640.940</b>
<i>Water Pump</i>	<b>TF8463</b>		
<b>B200 W245 Turbo</b>		<b>10/05-on</b>	<b>4 Cyl 2.0L M266.960</b>
<i>Water Pump</i>	<b>TF8463</b>		
<b>B200T W245</b>		<b>7/10-on</b>	<b>4 Cyl 2.0L M266.980</b>
<i>Water Pump</i>	<b>TF8463</b>		
<b>C43, C43T AMG W202, S202</b>		<b>4/98-1/01</b>	<b>V8 4.3L M113.944</b>
<i>Water Pump</i>	<b>TF8119</b>		
<i>Thermostat &amp; Housing</i>	<b>TTH575</b>		
<b>C55 AMG W203</b>		<b>10/04-8/07</b>	<b>V8 5.4L M113.988</b>
<i>Water Pump</i>	<b>TF8119</b>		
<i>Thermostat &amp; Housing</i>	<b>TTH575</b>		

Description	Part No	Year & Notes	Engine
<b>MERCEDES BENZ</b>			
<b>C180 W202</b>		2/94-11/00	4 Cyl 1.8L M111.951
Water Pump	TF4035		
<b>C180K, CL203, W203 Kompressor</b>		10/02-4/08	4 Cyl 1.8L M271.946, M271.940
Water Pump	TF8302		
<b>C180, CL203, W203</b>		12/01-10/02	4 Cyl 2.0L M111.951
Water Pump	TF8200		
<b>C200, C200T W202, S202</b>		10/96-7/01	4 Cyl 2.0L M111.940
Water Pump	TF4035	To 10/00	
Water Pump	TF8200	From 11/00	
<b>C200 W203 Kompressor</b>		11/00-10/02	4 Cyl 2.0L M111.955
Water Pump	TF8399		
Thermostat & Housing	TTH574		
<b>C200 W204 Supercharged</b>		4/08-on	4 Cyl 1.8L M271 E18
Water Pump	TF8302		
<b>C200K, CL203, W203, W204 Kompressor</b>		10/02-on	4 Cyl 1.8L M271.940, M271.950
Water Pump	TF8302		
<b>C220 W203 Turbo Diesel</b>		2/04-9/07	4 Cyl 2.1L M611.962, M646.963
Water Pump	TF8389	To 2/04	
Water Pump	TF8303	From 2/04	
<b>C220 W202</b>		3/94-11/96	4 Cyl 2.2L M111.961
Water Pump	TF4035		
Thermostat & Housing	TTH574		
<b>C220 W204 Turbo Diesel</b>		40367	4 Cyl 2.1L OM646
Water Pump	TF8303		
<b>C230K CL203</b>		9/04-8/05	4 Cyl 1.8L M271
Water Pump	TF8302		
<b>C240 S202, W202, W203</b>		9/97-8/05	V6 2.4L, 2.6L M112.911, M112.912
Water Pump	TF8119		
Thermostat & Housing	TTH575		
<b>C250D, C250TD W202 incl. Turbo</b>		10/94-2/00	5 Cyl 2.5L M605.910, M605.960
Water Pump	TF8121		

Description	Part No	Year & Notes	Engine
<b>MERCEDES BENZ</b>			
<b>C280 W202 Dohc</b>		8/97-11/00	6 Cyl 2.8L M112.920
<i>Water Pump</i>	<b>TF8119</b>		
<b>C280 W202 Sohc</b>		8/97-11/00	V6 2.8L M112.920
<i>Thermostat &amp; Housing</i>	<b>TTH575</b>		
<b>C320 W203</b>		11/00-8/05	V6 3.2L M112.955
<i>Water Pump</i>	<b>TF8400</b>		
<b>CLK55 A209, C209</b>		7/03-7/06	V8 5.4L M113.987
<i>Water Pump</i>	<b>TF8119</b>		
<b>CLK200 A209</b>		8/04-on	4 Cyl 1.8L M272.240
<i>Water Pump</i>	<b>TF8302</b>		
<b>CLK230 C208</b>		10/97-4/03	4 Cyl 2.3L M111.982
<i>Water Pump</i>	<b>TF8411</b>		
<i>Thermostat &amp; Housing</i>	<b>TTH574</b>		
<b>CLK240 C209</b>		12/02-9/05	V6 2.6L M112.912
<i>Water Pump</i>	<b>TF8119</b>		
<i>Thermostat &amp; Housing</i>	<b>TTH575</b>		
<b>CLK320 A208, C208</b>		10/97-9/05	V6 3.2L M112.941, M112.955
<i>Water Pump</i>	<b>TF8119</b>		
<i>Thermostat &amp; Housing</i>	<b>TTH575</b>		
<b>CLK430 A208, C208</b>		11/99-1/03	V8 4.3L M113
<i>Water Pump</i>	<b>TF8119</b>		
<i>Thermostat &amp; Housing</i>	<b>TTH575</b>		
<b>CLS500 C219</b>		5/05-on	V8 5.0L M113.967
<i>Water Pump</i>	<b>TF8400</b>		
<b>E55 AMG W210</b>		4/98-8/02	V8 5.4L M113
<i>Water Pump</i>	<b>TF8119</b>		
<i>Thermostat &amp; Housing</i>	<b>TTH575</b>		
<b>E63 S211, W211</b>		9/06-on	V8 6.2L M113.967
<i>Water Pump</i>	<b>TF8400</b>		

Description	Part No	Year & Notes	Engine
<b>MERCEDES BENZ</b>			
<b>E200 W211 Kompressor</b>		10/04-on	4 Cyl 1.8L M272.940, M271.941
Water Pump	TF8302		
<b>E220 W124</b>		9/93-1/96	4 Cyl 2.2L M111.960
Water Pump	TF4035		
Thermostat & Housing	TTH574		
<b>E230 W210</b>		1/96-1/98	4 Cyl 2.3L M111.970
Water Pump	TF4035		
<b>E240 S210, W210</b>		1/98-3/03	V6 2.4L M112.911
Water Pump	TF8119		
<b>E240 W211</b>		8/02-9/05	V6 2.6L M112.913
Water Pump	TF8119		
<b>E270 W210</b>		10/99-8/02	V6 2.7L M612.963
Water Pump	TF8389		
<b>E270 W211</b>		8/02-9/05	V6 2.7L M647.961
Water Pump	TF8303		
<b>E280, E280T S124, W124, W210</b>		9/93-3/01	V6 2.8L M104.942, M112.921
Water Pump	TF8119	<i>From 9/98</i>	
<b>E280 S211, W211</b>		9/05-on	V6 3.0L M112.913
Water Pump	TF8400		
<b>E280 W211 Turbo Diesel</b>		09/05-12/09	V6 3.0L M272.943
Water Pump	TF8423	<i>From Eng. 30058494</i>	
Thermostat & Housing	TTH576		
<b>E280 S211 Turbo Diesel</b>		9/06-on	V6 3.0L M647.961
Water Pump	TF8303		
<b>E300D W210 Diesel</b>		9/93-12/99	6 Cyl 3.0L M606.910
Water Pump	TF8121		
<b>E320 W124, W210 Dohc</b>		9/93-8/02	V6 3.2L M104.992
Water Pump	TF8324	<i>From 6/95</i>	

Description	Part No	Year & Notes	Engine
<b>MERCEDES BENZ</b>			
<b>E320 S210, S211, W210, W211</b>	<b>Sohc</b>	<b>1/96-2/05</b>	<b>V6 3.2L M112.941</b>
<i>Water Pump</i>	<b>TF8119</b>	<i>To Eng. No. 30-791890</i>	
<i>Water Pump</i>	<b>TF8400</b>	<i>From Eng. No. 30-791891</i>	
<i>Thermostat &amp; Housing</i>	<b>TTH575</b>		
<b>E350 W211</b>		<b>2/05-on</b>	<b>V6 3.5L M272.964</b>
<i>Water Pump</i>	<b>TF8423</b>		
<i>Thermostat &amp; Housing</i>	<b>TTH576</b>		
<b>E430 W210</b>		<b>1/98-8/02</b>	<b>V8 4.3L M113.940</b>
<i>Water Pump</i>	<b>TF8400</b>		
<b>E500 W211</b>		<b>8/02-9/06</b>	<b>V8 5.0L M113.967</b>
<i>Water Pump</i>	<b>TF8119</b>		
<b>ML55 W163</b>		<b>1/01-9/05</b>	<b>V8 2.6L M113.98</b>
<i>Water Pump</i>	<b>TF8119</b>		
<b>ML63 W164</b>		<b>7/06-on</b>	<b>V8 6.2L M156.980</b>
<i>Water Pump</i>	<b>TF8400</b>		
<b>ML270 W163 Turbo Diesel</b>		<b>2/00-9-05</b>	<b>5 Cyl 2.7L M113.965, M612.963</b>
<i>Water Pump</i>	<b>TF8389</b>		
<b>ML320 W164 Diesel</b>		<b>9/05-11/08</b>	<b>V6 3.0L M642.940</b>
<i>Water Pump</i>	<b>TF8422</b>		
<i>Thermostat &amp; Housing</i>	<b>TTH576</b>		
<b>ML320 W163 Petrol</b>		<b>9/98-4/03</b>	<b>V6 3.2L M112.942</b>
<i>Water Pump</i>	<b>TF8400</b>		
<i>Thermostat &amp; Housing</i>	<b>TTH575</b>		
<b>ML350 W164</b>		<b>9/05-11/08</b>	<b>V6 3.0L M272.967</b>
<i>Water Pump</i>	<b>TF8423</b>		
<b>ML430</b>		<b>3/99-11/01</b>	<b>V8 4.3L M113.942</b>
<i>Water Pump</i>	<b>TF8119</b>		
<b>ML500 W163</b>		<b>4/05-9/05</b>	<b>V8 5.0L M113.965</b>
<i>Water Pump</i>	<b>TF8119</b>		
<i>Thermostat &amp; Housing</i>	<b>TTH575</b>		



Description	Part No	Year & Notes	Engine
<b>MERCEDES BENZ</b>			
<b>R500 W251</b>		4/06-11/07	V8 5.0L M113.971
<i>Water Pump</i>	<b>TF8119</b>		
<i>Thermostat &amp; Housing</i>	<b>TTH575</b>		
<b>S280 W140</b>		10/95-4/99	6 Cyl 2.8L M104.944
<i>Water Pump</i>	<b>TF8241</b>		
<b>S320 W220</b>		4/99-2/03	6 Cyl 3.2L M112.944
<i>Water Pump</i>	<b>TF8119</b>		
<b>S350 W220</b>		2/03-2/06	V6 3.7L M112
<i>Water Pump</i>	<b>TF8400</b>		
<i>Thermostat &amp; Housing</i>	<b>TTH575</b>		
<b>SL430, S430L W220</b>		4/99-2/06	V8 4.3L M113
<i>Water Pump</i>	<b>TF8119</b>		
<i>Thermostat &amp; Housing</i>	<b>TTH575</b>		
<b>S500L W220 Sohc</b>		3/03-1/06	V8 5.0L M113
<i>Water Pump</i>	<b>TF8119</b>		
<i>Thermostat &amp; Housing</i>	<b>TTH575</b>		
<b>SL320 R129</b>		2/99-10/01	V6 3.2L M112.941
<i>Water Pump</i>	<b>TF8400</b>		
<i>Thermostat &amp; Housing</i>	<b>TTH575</b>		
<b>SL350 R230</b>		5/06-4/08	V6 3.5L M112.973
<i>Water Pump</i>	<b>TF8400</b>		
<b>SL350 R230</b>		10/03-5/06	V6 3.7L M272.968
<i>Water Pump</i>	<b>TF8119</b>		
<i>Thermostat &amp; Housing</i>	<b>TTH575</b>		
<b>SLK200 R170</b>		11/97-11/00	4 Cyl 2.0L M111.946
<i>Water Pump</i>	<b>TF4035</b>		
<i>Thermostat &amp; Housing</i>	<b>TTH575</b>		
<b>SLK200 R170</b>		9/02-8/04	4 Cyl 2.0L M111.940
<i>Water Pump</i>	<b>TF8399</b>		
<i>Thermostat &amp; Housing</i>	<b>TTH574</b>		
<b>SLK320 R170</b>		9/02-8/04	V6 3.2L M119.247
<i>Water Pump</i>	<b>TF8119</b>		

Description	Part No	Year & Notes	Engine
<b>MERCEDES BENZ</b>			
<b>Sprinter 208CDi</b>		<b>3/02-3/03</b>	<b>4 Cyl 2.2L M611.981</b>
Water Pump	<b>TF8360</b>		
Thermostat & Housing	<b>TTH577</b>		
<b>Sprinter 308CDi</b>		<b>5/00-10/06</b>	<b>4 Cyl 2.2L M611.981</b>
Water Pump	<b>TF8360</b>		
Thermostat & Housing	<b>TTH577</b>		
<b>Sprinter 308D</b>		<b>2/98-5/00</b>	<b>4 Cyl 2.3L M601.942</b>
Water Pump	<b>TF8121</b>		
<b>Sprinter 309CDi</b>		<b>10/06-on</b>	<b>4 Cyl 2.1L M646.984</b>
Water Pump	<b>TF8304</b>		
Thermostat & Housing	<b>TTH577</b>		
<b>Sprinter 311CDi</b>		<b>10/06-on</b>	<b>4 Cyl 2.1L M646.985</b>
Water Pump	<b>TF8304</b>		
Thermostat & Housing	<b>TTH577</b>		
<b>Sprinter 312D</b>		<b>1/98-4/00</b>	<b>5 Cyl 2.9L M602</b>
Water Pump	<b>TF8121</b>		
<b>Sprinter 313CDi</b>		<b>5/00-10/06</b>	<b>4 Cyl 2.2L M611.981</b>
Water Pump	<b>TF8359</b>	<i>To 7/03</i>	
Water Pump	<b>TF8304</b>	<i>From 8/03</i>	
<b>Sprinter 316CDi</b>		<b>6/03-10/06</b>	<b>5 Cyl 2.7L M612.963</b>
Water Pump	<b>TF8360</b>		
Thermostat & Housing	<b>TTH577</b>		
<b>Sprinter 412D</b>		<b>1/98-1/00</b>	<b>5 Cyl 2.9L M602.980</b>
Water Pump	<b>TF8121</b>		
<b>Sprinter 413CDi</b>		<b>5/00-10/06</b>	<b>4 Cyl 2.2L M611.981</b>
Water Pump	<b>TF8359</b>	<i>To 7/03</i>	
Water Pump	<b>TF8304</b>	<i>From 8/03</i>	
<b>Sprinter 416CDi</b>		<b>6/03-10/06</b>	<b>5 Cyl 2.7L M612.963</b>
Water Pump	<b>TF8360</b>		
Thermostat & Housing	<b>TTH577</b>		
<b>Sprinter 616CDi</b>		<b>4/02-10/06</b>	<b>5 Cyl 2.7L M612.963</b>
Water Pump	<b>TF8360</b>		
Thermostat & Housing	<b>TTH577</b>		

Description	Part No	Year & Notes	Engine
<b>MERCEDES BENZ</b>			
<b>Vito 108CDi</b>		7/99-4/04	4 Cyl 2.2L M611.980
<i>Water Pump</i>	<b>TF8359</b>		
<b>Vito 108D</b>		1/98-7/99	4 Cyl 2.3L M601.942
<i>Water Pump</i>	<b>TF8121</b>		
<b>Vito 109CDi</b>		4/04-1/09	4 Cyl 2.1L M646.981, M646.983
<i>Water Pump</i>	<b>TF8304</b>		
<i>Thermostat &amp; Housing</i>	<b>TTH577</b>		
<b>Vito 111CDi</b>		1/08-on	4 Cyl 2.1L M646.980
<i>Water Pump</i>	<b>TF8304</b>		
<i>Thermostat &amp; Housing</i>	<b>TTH577</b>		
<b>Vito 112CDi</b>		2/01-4/01	4 Cyl 2.2L M611.980
<i>Water Pump</i>	<b>TF8359</b>		
<b>Vito 113</b>		2/98-3/04	4 Cyl 2.0L M111.948
<i>Water Pump</i>	<b>TF8118</b>		
<i>Thermostat &amp; Housing</i>	<b>TTH574</b>		
<b>Vito 115CDi</b>		4/04-on	4 Cyl 2.1L M646.982
<i>Water Pump</i>	<b>TF8304</b>		
<i>Thermostat &amp; Housing</i>	<b>TTH577</b>		
<b>Vito 119P</b>		4/04-10/06	V6 3.2L
<i>Water Pump</i>	<b>TF8304</b>		
<i>Thermostat &amp; Housing</i>	<b>TTH575</b>		
<b>MG</b>			
<b>MGB, MGB GT, MK3</b>		1968-76	4 Cyl 1.1L, 1.3L, 1.8L
<i>Water Pump</i>	<b>TF738</b>		
<b>MGF, ZR160</b>		3/97-on	4 Cyl 1.8L
<i>Water Pump</i>	<b>TF8182</b>		
<b>TF, ZR K Series Dohc</b>		9/02-3/05	4 Cyl 1.8L
<i>Water Pump</i>	<b>TF8182</b>		
<b>ZT 180, 190, 220 Dohc</b>		8/04-3/05	V6 2.5L KV6
<i>Water Pump</i>	<b>TF8256</b>		

Description	Part No	Year & Notes	Engine
<b>MINI</b>			
<b>850, Mini, Clubman, Moke</b>		<b>1960-12/83</b>	<b>4 Cyl All</b>
<i>Water Pump</i>	<b>TF3709</b>		
<b>Cooper R50 MPFi</b>		<b>3/02-3/09</b>	<b>4 Cyl 1.6L W10B16A</b>
<i>Water Pump</i>	<b>TF8260</b>		
<b>Cooper R53 Supercharged</b>		<b>1/02-3/09</b>	<b>4 Cyl 1.6L W11B16A</b>
<i>Water Pump</i>	<b>TF8420</b>		
<b>Cooper R55, R56, R57 incl. Turbo</b>		<b>3/08-on</b>	<b>4 Cyl 1.6L N12B16A, N14B16</b>
<i>Water Pump</i>	<b>TF8428</b>		
<b>Cooper R56 Turbo Diesel</b>		<b>3/08-on</b>	<b>4 Cyl 1.6L 9HZT</b>
<i>Water Pump</i>	<b>TF8432</b>		
<i>Thermostat &amp; Housing</i>	<b>TTH589</b>		
<b>MITSUBISHI</b>			
<b>380</b>		<b>9/05-9/08</b>	<b>V6 3.8L 6G75</b>
<i>Water Pump</i>	<b>TF4014</b>	<i>Pump without Housing</i>	
<i>Water Pump</i>	<b>TF4014H</b>	<i>Pump with Housing</i>	
<i>Timing Belt Kit</i>	<b>TFK099H</b>	<i>Kit contains Hydraulic Tensioner</i>	
<i>Timing Belt Kit with Water Pump</i>	<b>TFK099HP</b>	<i>Kit with Hydraulic Tensioner &amp; TF4014 Pump without Housing</i>	
<i>Timing Belt Kit with Water Pump</i>	<b>TFK099HPC</b>	<i>Kit with Hydraulic Tensioner &amp; TF4014H Pump with Housing</i>	
<i>Timing Belt Kit</i>	<b>TFK099</b>		
<i>Timing Belt Kit with Water Pump</i>	<b>TFK099P</b>	<i>Kit contains TF4014 Pump without Housing</i>	
<i>Timing Belt Kit with Water Pump</i>	<b>TFK099PC</b>	<i>Kit contains TF4014H Pump with Housing</i>	
<b>Canter FC Series</b>		<b>1979-7/92</b>	<b>4 Cyl 2.4L, 2.6L 4G53, 4G54</b>
<i>Water Pump</i>	<b>TF2799</b>		
<b>Canter FB Series</b>		<b>5/98-11/02</b>	<b>4 Cyl 2.8L 4M40</b>
<i>Water Pump</i>	<b>TF8190</b>		
<b>Canter FE Series incl. Turbo</b>		<b>1/84-7/97</b>	<b>4 Cyl 3.3L 4D30, 4D31</b>
<i>Water Pump</i>	<b>TF1160</b>		
<b>Canter FE, FG Series incl. Turbo</b>		<b>10/90-11/02</b>	<b>4 Cyl 3.9L, 4.2L 4D33, 4D34</b>
<i>Water Pump</i>	<b>TF8191</b>		

Description	Part No	Year & Notes	Engine
<b>MITSUBISHI</b>			
<b>Challenger PA</b>			
		<b>3/98-3/07</b>	<b>V6 3.0L 6G72</b>
Water Pump	<b>TF4018</b>	<i>Pump without Housing</i>	
Water Pump	<b>TF4018H</b>	<i>Pump with Housing</i>	
Fan Clutch	<b>TFC105</b>		
Timing Belt Kit	<b>TFK113</b>		
Timing Belt Kit	<b>TFK113H</b>	<i>Kit contains Hydraulic Tensioner</i>	
<b>Challenger Turbo Diesel (NZ Model)</b>			
		<b>1/96-1/00</b>	<b>4 Cyl 2.8L 4M40T</b>
Timing Chain Kit	<b>TCK106</b>	<i>Single Row Timing Chain</i>	
Timing Chain Kit	<b>TCK107</b>	<i>Double Row Timing Chain</i>	
<b>Challenger KH, PB Turbo Diesel</b>			
		<b>12/09-on</b>	<b>4 Cyl 2.5L 4D56T</b>
Water Pump	<b>TF8486</b>		
Fan Clutch	<b>TFC235</b>		
Radiator Fan Blade	<b>TFB545</b>		
<b>Colt RA</b>			
		<b>1/81-10/82</b>	<b>4 Cyl 1.4L 4G12</b>
Water Pump	<b>TF877</b>		
<b>Colt RB, RC, RD, RE</b>			
		<b>10/82-5/91</b>	<b>4 Cyl 1.4L, 1.6L 4G32, 4G33</b>
Water Pump	<b>TF878</b>		
<b>Colt RG</b>			
		<b>8/04-2/08</b>	<b>4 Cyl 1.5L 4G15</b>
Water Pump	<b>TF8365</b>		
<b>Colt RG</b>			
		<b>1/06-on</b>	<b>4 Cyl 1.5L 4A91</b>
Water Pump	<b>TF8364</b>		
<b>Colt RZ Cabriolet Turbo</b>			
		<b>11/06-on</b>	<b>4 Cyl 1.5L 4G15</b>
Water Pump	<b>TF8365</b>		
<b>Cordia AA</b>			
		<b>4/83-10/84</b>	<b>4 Cyl 1.6L 4G32</b>
Water Pump	<b>TF878</b>		
<b>Cordia AA, AB, AC incl. Turbo</b>			
		<b>3/84-7/89</b>	<b>4 Cyl 1.8L 4G37, 4G62</b>
Water Pump	<b>TF1027</b>		
<b>Delica P25W, P35W Turbo Diesel</b>			
		<b>1/89-12/95</b>	<b>4 Cyl 2.5L 4D56T</b>
Water Pump	<b>TF1032</b>		
Fan Clutch	<b>TFC105</b>	<i>To 9/90</i>	
Fan Clutch	<b>TFC231</b>	<i>From 10/90</i>	
Timing Belt Kit	<b>TFK080</b>		



Description	Part No	Year & Notes	Engine
<b>MITSUBISHI</b>			
<b>Delica PD, PE Turbo Diesel</b>		<b>1/95-12/07</b>	<b>4 Cyl 2.8L 4M40T</b>
Water Pump	<b>TF3115</b>		
Fan Clutch	<b>TFC211</b>	<i>To 6/96</i>	
Fan Clutch	<b>TFC153</b>	<i>From 7/96</i>	
Radiator Fan Blade	<b>TFB521</b>		
Timing Chain Kit	<b>TCK106</b>	<i>Single Row Timing Chain</i>	
Timing Chain Kit	<b>TCK107</b>	<i>Double Row Timing Chain</i>	
<b>Express L200 MA, MB</b>		<b>3/80-9/82</b>	<b>4 Cyl 1.6L 4G32</b>
Water Pump	<b>TF1014</b>		
<b>Express L200 MA, MB</b>		<b>3/80-10/82</b>	<b>4 Cyl 2.0L 4G52</b>
Water Pump	<b>TF1009</b>		
Fan Clutch	<b>TFC117</b>		
<b>Express L200 MC, MD</b>		<b>10/82-10/86</b>	<b>4 Cyl 1.6L 4G32</b>
Water Pump	<b>TF1014</b>		
<b>Express L200 MC, MD</b>		<b>10/82-10/86</b>	<b>4 Cyl 2.0L 4G63</b>
Water Pump	<b>TF3117</b>		
Fan Clutch	<b>TFC125</b>		
<b>Express L200 MC, MD Diesel</b>		<b>10/82-10/86</b>	<b>4 Cyl 2.3L 4D55</b>
Water Pump	<b>TF1032</b>		
Fan Clutch	<b>TFC105</b>		
Timing Belt Kit	<b>TFK080</b>		
<b>Express L300 SA, SB, SC, SD, SE</b>		<b>4/80-10/86</b>	<b>4 Cyl 1.6L 4G32</b>
Water Pump	<b>TF1014</b>		
<b>Express L300 SB, SC, SD, SE</b>		<b>10/82-10/86</b>	<b>4 Cyl 1.8L, 2.0L 4G62, 4G63</b>
Water Pump	<b>TF3117</b>		
Fan Clutch	<b>TFC125</b>	<i>Check Measurements some Models use TFC117</i>	
<b>Express L300 SF, SG, SH Diesel</b>		<b>10/86-9/95</b>	<b>4 Cyl 2.0L, 2.4L 4G63, 4G64</b>
Water Pump	<b>TF3117</b>	<i>Check Casting if different use TF8274, TF3117 has no weep hole</i>	
Water Pump	<b>TF8274</b>	<i>Casting has extra cast piece to cover Oil Hole &amp; Pump also has weep hole</i>	
Fan Clutch	<b>TFC150</b>		
Radiator Fan Blade	<b>TFB515</b>	<i>Suits 2.4L Model only</i>	
<b>Express L300 SF, SG, SH</b>		<b>10/86-9/95</b>	<b>4 Cyl 2.5L 4D56</b>
Water Pump	<b>TF1032</b>		
Fan Clutch	<b>TFC105</b>		
Timing Belt Kit	<b>TFK096</b>		

Description	Part No	Year & Notes	Engine
<b>MITSUBISHI</b>			
<b>Express L300 SJ</b>			
		<b>1/94-11/03</b>	<b>4 Cyl 2.0L 4G63</b>
Water Pump	<b>TF4008</b>	<i>Check Pump some Models use TF8274 with different Pump Casting</i>	
Water Pump	<b>TF8274</b>	<i>Casting has extra cast piece to cover Oil Hole &amp; Pump also has weep hole</i>	
Fan Clutch	<b>TFC150</b>		
Timing Belt Kit	<b>TFK104</b>		
<b>Express L300 SJ</b>			
		<b>1/98-7/08</b>	<b>4 Cyl 2.4L 4G64</b>
Water Pump	<b>TF4008</b>	<i>Check Pump some Models use TF8274 with different Pump Casting</i>	
Water Pump	<b>TF8274</b>	<i>Casting has extra cast piece to cover Oil Hole &amp; Pump also has weep hole</i>	
Fan Clutch	<b>TFC150</b>		
Radiator Fan Blade	<b>TFB515</b>		
Timing Belt Kit	<b>TFK123</b>	<i>Kit contains 124 Teeth x 29mm wide Timing Belt</i>	
<b>Express L300 SJ Diesel</b>			
		<b>12/94-5/04</b>	<b>4 Cyl 2.5L 4D56</b>
Water Pump	<b>TF1032</b>		
Fan Clutch	<b>TFC105</b>		
<b>Express L300 WA Efi</b>			
		<b>12/94-3/06</b>	<b>4 Cyl 2.4L 4G64</b>
Water Pump	<b>TF4008</b>	<i>Check Pump some Models use TF8274 with different Pump Casting</i>	
Water Pump	<b>TF8274</b>	<i>Casting has extra cast piece to cover Oil Hole &amp; Pump also has weep hole</i>	
Fan Clutch	<b>TFC150</b>		
Timing Belt Kit	<b>TFK123</b>		
<b>Galant GA, GB, GC, GD</b>			
		<b>8/71-6/77</b>	<b>4 Cyl 1.3L,1.5L,1.6L 4G30,4G31,4G32 Eng</b>
Water Pump	<b>TF822</b>		
<b>Galant HJ Sohc</b>			
		<b>4/93-3/95</b>	<b>4 Cyl 2.0L 4G63</b>
Water Pump	<b>TF3094</b>		
Timing Belt Kit	<b>TFK104</b>		
<b>Galant HJ Dohc</b>			
		<b>4/93-11/96</b>	<b>V6 2.0L 6A12</b>
Water Pump	<b>TF4012</b>		
<b>Galant HG, HH Sohc</b>			
		<b>5/89-4/94</b>	<b>4 Cyl 2.0L 4G63</b>
Water Pump	<b>TF3061</b>		
<b>Galant HG, HH GSR, VR4 Dohc</b>			
		<b>5/89-3/93</b>	<b>4 Cyl 2.0L 4G63, 4G63T</b>
Water Pump	<b>TF3060</b>	<i>GSR, VR4 Model including Turbo</i>	
Timing Belt Kit	<b>TFK059</b>		
<b>Grandis BA</b>			
		<b>5/04-on</b>	<b>4 Cyl 2.4L 4G69</b>
Water Pump	<b>TF8363</b>	<i>To 2/06</i>	
Water Pump	<b>TF8334</b>	<i>From 3/06</i>	

Description	Part No	Year & Notes	Engine
<b>MITSUBISHI</b>			
<b>Lancer LA, LB</b>		<b>9/74-4/79</b>	<b>4 Cyl 1.4L 4G33</b>
<i>Water Pump</i>	<b>TF822</b>	<i>Chain Driven Engine</i>	
<b>Lancer LB, LC</b>		<b>4/77-8/81</b>	<b>4 Cyl 1.6L 4G32</b>
<i>Water Pump</i>	<b>TF1014</b>	<i>Belt Driven Engine</i>	
<b>Lancer CA</b>		<b>4/88-8/90</b>	<b>4 Cyl 1.5L 4G15</b>
<i>Water Pump</i>	<b>TF877</b>		
<i>Timing Belt Kit</i>	<b>TFK063</b>		
<b>Lancer CB</b>		<b>9/90-9/92</b>	<b>4 Cyl 1.5L 4G15</b>
<i>Water Pump</i>	<b>TF877</b>		
<i>Timing Belt Kit</i>	<b>TFK003</b>		
<b>Lancer CB</b>		<b>9/90-9/92</b>	<b>4 Cyl 1.6L 4G61</b>
<i>Water Pump</i>	<b>TF3020</b>		
<b>Lancer CC</b>		<b>1/92-7/96</b>	<b>4 Cyl 1.5L 4G15</b>
<i>Water Pump</i>	<b>TF877</b>		
<i>Timing Belt Kit</i>	<b>TFK003</b>		
<b>Lancer CC incl. Turbo</b>		<b>9/92-7/96</b>	<b>4 Cyl 1.6L 4G92</b>
<i>Water Pump</i>	<b>TF3092</b>		
<b>Lancer CC incl. Turbo</b>		<b>9/92-7/96</b>	<b>4 Cyl 1.8L 4G93</b>
<i>Water Pump</i>	<b>TF3092</b>		
<i>Timing Belt Kit</i>	<b>TFK064</b>		
<b>Lancer CE</b>		<b>7/96-11/04</b>	<b>4 Cyl 1.5L 4G15</b>
<i>Water Pump</i>	<b>TF4108</b>	<i>All</i>	
<i>Timing Belt Kit</i>	<b>TFK003</b>	<i>To 12/96</i>	
<i>Timing Belt Kit</i>	<b>TFK107</b>	<i>From 12/96</i>	
<b>Lancer CE</b>		<b>7/96-11/04</b>	<b>4 Cyl 1.8L 4G93</b>
<i>Water Pump</i>	<b>TF4065</b>	<i>Suits Sedan &amp; Hatch</i>	
<i>Water Pump</i>	<b>TF3092</b>	<i>Suits Wagon</i>	
<i>Timing Belt Kit</i>	<b>TFK133</b>		
<b>Lancer Evo CE Ralliart Turbo</b>		<b>1/00-12/04</b>	<b>4 Cyl 2.0L 4G63T</b>
<i>Water Pump</i>	<b>TF8188</b>		
<b>Lancer CG, CH Sohc</b>		<b>7/02-5/07</b>	<b>4 Cyl 2.0L 4G94</b>
<i>Water Pump</i>	<b>TF4065</b>		
<i>Timing Belt Kit</i>	<b>TFK195H</b>		

Description	Part No	Year & Notes	Engine
<b>MITSUBISHI</b>			
<b>Lancer CH, CS Dohc</b>		<b>8/05-10/09</b>	<b>4 Cyl 2.4L 4G69</b>
Water Pump	<b>TF8363</b>		
Timing Belt Kit	<b>TFK196</b>		
Timing Belt Kit	<b>TFK196H</b>	<i>Kit contains Hydraulic Tensioner</i>	
<b>Lancer CJ</b>		<b>10/07-on</b>	<b>4 Cyl 2.0L, 2.4L 4B11, 4B12</b>
Water Pump	<b>TF8366</b>	<i>Without housing</i>	
Water Pump	<b>TF8366H</b>	<i>With housing</i>	
<b>Lancer Evo CY, CZ Turbo</b>		<b>7/04-7/08</b>	<b>4 Cyl 2.0L 4G63T</b>
Water Pump	<b>TF8363</b>		
<b>Magna TE, TF</b>		<b>4/96-3/99</b>	<b>4 Cyl 2.4L 4G64</b>
Water Pump	<b>TF8187</b>		
Timing Belt Kit	<b>TFK104</b>		
<b>Magna TE, TF, TH, TJ</b>		<b>4/96-7/02</b>	<b>V6 3.0L 6G72</b>
Water Pump	<b>TF4014</b>	<i>Pump without Housing</i>	
Water Pump	<b>TF4014H</b>	<i>Pump with Housing</i>	
Timing Belt Kit	<b>TFK113</b>		
Timing Belt Kit	<b>TFK113H</b>	<i>Kit contains Hydraulic Tensioner</i>	
Timing Belt Kit with Water Pump	<b>TFK113P</b>	<i>Kit contains TF4014 Pump</i>	
Timing Belt Kit with Water Pump	<b>TFK113HPC</b>	<i>Kit contains TF4014H Pump</i>	
<b>Magna TH, TJ, TL</b>		<b>3/99-10/04</b>	<b>V6 3.5L 6G74</b>
Water Pump	<b>TF4014</b>	<i>Pump without Housing</i>	
Water Pump	<b>TF4014H</b>	<i>Pump with Housing</i>	
Timing Belt Kit	<b>TFK099H</b>	<i>Kit contains Hydraulic Tensioner</i>	
Timing Belt Kit with Water Pump	<b>TFK099HP</b>	<i>Kit with Hydraulic Tensioner &amp; TF4014 Pump without Housing</i>	
Timing Belt Kit with Water Pump	<b>TFK099HPC</b>	<i>Kit with Hydraulic Tensioner &amp; TF4014H Pump with Housing</i>	
Timing Belt Kit	<b>TFK099</b>		
Timing Belt Kit with Water Pump	<b>TFK099P</b>	<i>Kit contains TF4014 Pump without Housing</i>	
Timing Belt Kit with Water Pump	<b>TFK099PC</b>	<i>Kit contains TF4014H Pump with Housing</i>	
<b>Magna TM, TN, TP, TR, TS</b>		<b>4/85-12/96</b>	<b>4 Cyl 2.6L 4G54</b>
Water Pump	<b>TF1025</b>	<i>Pump without Housing</i>	
Water Pump	<b>TF1025BP</b>	<i>Pump with Housing</i>	
Heater Valve / Tap	<b>TFT7006</b>	<i>To 10/91</i>	

Description	Part No	Year & Notes	Engine
<b>MITSUBISHI</b>			
<b>Magna TR, TS</b>			
		<b>3/93-12/96</b>	<b>V6 3.0L 6G72</b>
Water Pump	<b>TF2040</b>	<i>Pump without Housing 40.5mm OD O-Ring</i>	
Water Pump	<b>TF2040H</b>	<i>Pump with Housing</i>	
Timing Belt Kit with Water Pump	<b>TFK058P</b>	<i>Kit contains TF2040 Pump without Housing</i>	
Timing Belt Kit with Water Pump	<b>TFK058PC</b>	<i>Kit contains TF2040H Pump with Housing</i>	
<b>Magna TW</b>			
		<b>10/04-5/06</b>	<b>V6 3.5L 6G74</b>
Water Pump	<b>TF4014</b>	<i>Pump without Housing</i>	
Water Pump	<b>TF4014H</b>	<i>Pump with Housing</i>	
Timing Belt Kit	<b>TFK099H</b>	<i>Kit contains Hydraulic Tensioner</i>	
Timing Belt Kit with Water Pump	<b>TFK099HP</b>	<i>Kit with Hydraulic Tensioner &amp; TF4014 Pump without Housing</i>	
Timing Belt Kit with Water Pump	<b>TFK099HPC</b>	<i>Kit with Hydraulic Tensioner &amp; TF4014H Pump with Housing</i>	
Timing Belt Kit	<b>TFK099</b>		
Timing Belt Kit with Water Pump	<b>TFK099P</b>	<i>Kit contains TF4014 Pump without Housing</i>	
Timing Belt Kit with Water Pump	<b>TFK099PC</b>	<i>Kit contains TF4014H Pump with Housing</i>	
<b>Mirage CE</b>			
		<b>7/96-8/04</b>	<b>4 Cyl 1.5L 4G15</b>
Water Pump	<b>TF4108</b>		
Timing Belt Kit	<b>TFK107</b>	<i>To 8/02</i>	
Timing Belt Kit with Water Pump	<b>TFK107P</b>	<i>Kit contains TF4108 Pump To 8/02</i>	
<b>Nimbus UA, UB</b>			
		<b>5/84-8/87</b>	<b>4 Cyl 1.8L 4G37</b>
Water Pump	<b>TF878</b>		
<b>Nimbus UC</b>			
		<b>1/86-1/92</b>	<b>4 Cyl 2.0L 4G63</b>
Water Pump	<b>TF1027</b>		
<b>Nimbus UF</b>			
		<b>1/92-11/98</b>	<b>4 Cyl 2.4L 4G64</b>
Water Pump	<b>TF3094</b>		
Timing Belt Kit	<b>TFK123</b>		
<b>Nimbus UG</b>			
		<b>11/98-5/05</b>	<b>4 Cyl 2.4L 4G64</b>
Water Pump	<b>TF8187</b>		
<b>Outlander ZE Sohc</b>			
		<b>1/03-7/04</b>	<b>4 Cyl 2.4L 4G64</b>
Water Pump	<b>TF8188</b>		
<b>Outlander ZF Sohc</b>			
		<b>1/03-7/06</b>	<b>4 Cyl 2.4L 4G69</b>
Water Pump	<b>TF8363</b>		
Timing Belt Kit	<b>TFK196</b>		
Timing Belt Kit	<b>TFK196H</b>	<i>Kit contains Hydraulic Tensioner</i>	



Description	Part No	Year & Notes	Engine
<b>MITSUBISHI</b>			
<b>Outlander ZG, ZH Dohc</b>		<b>11/06-on</b>	<b>4 Cyl 2.4L 4B12</b>
Water Pump	<b>TF8366</b>	<i>Without Housing</i>	
Water Pump	<b>TF8366H</b>	<i>With Housing</i>	
<b>Outlander ZG, ZH Turbo Diesel</b>		<b>11/06-on</b>	<b>V6 3.0L 6B31</b>
Water Pump	<b>TF8333</b>		
<b>Pajero NA, NB, NC Turbo Diesel</b>		<b>1/83-10/86</b>	<b>4 Cyl 2.3L 4D55T</b>
Water Pump	<b>TF1032</b>		
Fan Clutch	<b>TFC105</b>		
Heater Valve / Tap	<b>TFT7007</b>		
Timing Belt Kit	<b>TFK080</b>		
<b>Pajero ND, NE Turbo Diesel</b>		<b>1/84-8/88</b>	<b>4 Cyl 2.5L 4D56T</b>
Water Pump	<b>TF1032</b>		
Fan Clutch	<b>TFC105</b>		
Heater Valve / Tap	<b>TFT7007</b>		
Timing Belt Kit	<b>TFK096</b>		
<b>Pajero NA, NB, NC, ND, NE</b>		<b>1/83-8/88</b>	<b>4 Cyl 2.6L 4G54</b>
Water Pump	<b>TF1009</b>		
Fan Clutch	<b>TFC117</b>		
Heater Valve / Tap	<b>TFT7007</b>		
<b>Pajero NF Turbo Diesel</b>		<b>8/88-10/89</b>	<b>4 Cyl 2.5L 4D56T</b>
Water Pump	<b>TF1032</b>		
Fan Clutch	<b>TFC105</b>		
Heater Valve / Tap	<b>TFT7007</b>		
Timing Belt Kit	<b>TFK096</b>		
<b>Pajero NF</b>		<b>8/88-10/89</b>	<b>4 Cyl 2.6L 4G54</b>
Water Pump	<b>TF1009</b>		
Fan Clutch	<b>TFC117</b>		
Heater Valve / Tap	<b>TFT7007</b>		
<b>Pajero NF</b>		<b>8/88-10/89</b>	<b>V6 3.0L 6G72</b>
Water Pump	<b>TF2040</b>	<i>Pump without Housing 40.5mm OD O-Ring</i>	
Water Pump	<b>TF3114</b>	<i>Pump with Housing</i>	
Fan Clutch	<b>TFC105</b>		
Timing Belt Kit	<b>TFK058</b>		
Timing Belt Kit with Water Pump	<b>TFK058P</b>	<i>Kit contains TF2040 Pump without Housing</i>	
Timing Belt Kit with Water Pump	<b>TFK058PC1</b>	<i>Kit contains TF3114 Pump with Housing</i>	

Description	Part No	Year & Notes	Engine
<b>MITSUBISHI</b>			
<b>Pajero NG, NH Turbo Diesel</b>		<b>10/89-10/93</b>	<b>4 Cyl 2.5L 4D56T</b>
Water Pump	<b>TF1032</b>		
Fan Clutch	<b>TFC105</b>		
Timing Belt Kit	<b>TFK096</b>		
<b>Pajero NG, NH</b>		<b>10/89-10/93</b>	<b>4 Cyl 2.6L 4G54</b>
Water Pump	<b>TF1009</b>		
Fan Clutch	<b>TFC117</b>		
<b>Pajero NG, NH</b>		<b>10/89-10/93</b>	<b>V6 3.0L 6G72</b>
Water Pump	<b>TF2040</b>	<i>Pump without Housing 40.5mm OD O-Ring</i>	
Water Pump	<b>TF3114</b>	<i>Pump with Housing</i>	
Fan Clutch	<b>TFC105</b>		
Timing Belt Kit	<b>TFK058</b>		
Timing Belt Kit with Water Pump	<b>TFK058P</b>	<i>Kit contains TF2040 Pump with Housing</i>	
Timing Belt Kit with Water Pump	<b>TFK058PC1</b>	<i>Kit contains TF3114 Pump without Housing</i>	
<b>Pajero NJ, NK Diesel incl. Turbo</b>		<b>12/93-10/97</b>	<b>4 Cyl 2.8L 4M40, 4M40T</b>
Water Pump	<b>TF3115</b>		
Fan Clutch	<b>TFC153</b>		
Timing Chain Kit	<b>TCK106</b>	<i>Single Row Timing Chain</i>	
Timing Chain Kit	<b>TCK107</b>	<i>Double Row Timing Chain</i>	
<b>Pajero NJ, NK</b>		<b>12/93-10/97</b>	<b>V6 3.0L 6G72</b>
Water Pump	<b>TF2040</b>	<i>Pump without Housing 40.5mm OD O-Ring</i>	
Water Pump	<b>TF3114</b>	<i>Pump with Housing</i>	
Fan Clutch	<b>TFC105</b>		
Timing Belt Kit	<b>TFK058</b>		
Timing Belt Kit with Water Pump	<b>TFK058P</b>	<i>Kit contains TF2040 Pump</i>	
<b>Pajero NJ, NK</b>		<b>12/93-10/97</b>	<b>V6 3.5L 6G74</b>
Water Pump	<b>TF4007</b>	<i>Pump without Housing 22.5mm OD O-Ring</i>	
Water Pump	<b>TF4007H</b>	<i>Pump with Housing</i>	
Fan Clutch	<b>TFC105</b>		
Radiator Fan Blade	<b>TFB544</b>		
<b>Pajero NL Turbo Diesel</b>		<b>9/97-5/00</b>	<b>4 Cyl 2.8L 4M40T</b>
Water Pump	<b>TF3115</b>		
Fan Clutch	<b>TFC211</b>		
Timing Chain Kit	<b>TCK106</b>	<i>Single Row Timing Chain</i>	
Timing Chain Kit	<b>TCK107</b>	<i>Double Row Timing Chain</i>	

Description	Part No	Year & Notes	Engine
<b>MITSUBISHI</b>			
<b>Pajero NL</b>			
		<b>9/97-5/00</b>	<b>V6 3.5L 6G74</b>
Water Pump	<b>TF4018</b>	<i>Pump without Housing</i>	
Water Pump	<b>TF4018H</b>	<i>Pump with Housing</i>	
Fan Clutch	<b>TFC105</b>		
Radiator Fan Blade	<b>TFB544</b>		
Timing Belt Kit	<b>TFK099H</b>	<i>Kit contains Hydraulic Tensioner</i>	
Timing Belt Kit with Water Pump	<b>TFK4018H</b>	<i>Kit with Hydraulic Tensioner &amp; TF4018 Pump without Housing</i>	
Timing Belt Kit with Water Pump	<b>TFK4018HC</b>	<i>Kit with Hydraulic Tensioner &amp; TF4018H Pump with Housing</i>	
<b>Pajero NM Turbo Diesel</b>			
		<b>5/00-11/02</b>	<b>4 Cyl 2.8L 4M40T</b>
Water Pump	<b>TF3115</b>		
Fan Clutch	<b>TFC212</b>		
Timing Chain Kit	<b>TCK106</b>	<i>Single Row Timing Chain</i>	
Timing Chain Kit	<b>TCK107</b>	<i>Double Row Timing Chain</i>	
<b>Pajero NM Turbo Diesel</b>			
		<b>5/02-11/02</b>	<b>4 Cyl 3.2L 4M41T</b>
Water Pump	<b>TF3115</b>		
Fan Clutch	<b>TFC212</b>		
<b>Pajero NM</b>			
		<b>5/00-11/02</b>	<b>V6 3.5L 6G74</b>
Water Pump	<b>TF8189</b>		
Fan Clutch	<b>TFC190</b>		
Timing Belt Kit	<b>TFK128</b>		
Timing Belt Kit	<b>TFK128H</b>	<i>Kit contains Hydraulic Tensioner</i>	
<b>Pajero NP Turbo Diesel</b>			
		<b>11/02-10/06</b>	<b>4 Cyl 3.2L 4M41T</b>
Water Pump	<b>TF3115</b>		
Fan Clutch	<b>TFC153</b>		
<b>Pajero NP</b>			
		<b>11/02-10/06</b>	<b>V6 3.5L, 3.8L 6G74, 6G75</b>
Water Pump	<b>TF8189</b>		
Fan Clutch	<b>TFC190</b>		
Timing Belt Kit	<b>TFK128</b>		
Timing Belt Kit	<b>TFK128H</b>	<i>Kit contains Hydraulic Tensioner</i>	
<b>Pajero NS Turbo Diesel</b>			
		<b>10/06-12/08</b>	<b>4 Cyl 3.2L 4M41T</b>
Water Pump	<b>TF8335</b>		
Fan Clutch	<b>TFC202</b>		
<b>Pajero NS</b>			
		<b>10/06-12/08</b>	<b>V6 3.8L 6G75</b>
Water Pump	<b>TF8189</b>		
Fan Clutch	<b>TFC210</b>		
Timing Belt Kit	<b>TFK128</b>		
Timing Belt Kit	<b>TFK128H</b>	<i>Kit contains Hydraulic Tensioner</i>	

Description	Part No	Year & Notes	Engine
<b>MITSUBISHI</b>			
<b>Pajero NT Turbo Diesel</b>		<b>12/08-10/11</b>	<b>4 Cyl 3.2L 4M41T</b>
Water Pump	<b>TF8413</b>		
Fan Clutch	<b>TFC202</b>		
Radiator Fan Blade	<b>TFB545</b>		
<b>Pajero NT</b>		<b>12/08-10/11</b>	<b>V6 3.8L 6G75</b>
Water Pump	<b>TF8189</b>		
Fan Clutch	<b>TFC210</b>		
Timing Belt Kit	<b>TFK128</b>		
Timing Belt Kit	<b>TFK128H</b>	<i>Kit contains Hydraulic Tensioner</i>	
<b>Pajero iO QA</b>		<b>3/99-10/01</b>	<b>4 Cyl 1.6L 4G18</b>
Water Pump	<b>TF4108</b>		
<b>Pajero iO QA</b>		<b>3/99-10/01</b>	<b>4 Cyl 1.8L 4G93</b>
Water Pump	<b>TF4065</b>		
Timing Belt Kit	<b>TFK133</b>		
<b>Pajero iO QA</b>		<b>10/01-4/03</b>	<b>4 Cyl 2.0L 4G94</b>
Water Pump	<b>TF4065</b>		
<b>Scorpion GE, GH, GJ, GK, GL</b>		<b>3/78-9/85</b>	<b>4 Cyl 2.0L, 2.6L 4G52, 4G54</b>
Water Pump	<b>TF1009</b>		
Fan Clutch	<b>TFC117</b>		
<b>Sigma GE, GH, GJ, GK, GL</b>		<b>10/77-9/85</b>	<b>4 Cyl 1.6L 4G32</b>
Water Pump	<b>TF1014</b>	<i>Belt Driven Engine</i>	
<b>Sigma GE, GH, GJ, GK, GL, GN</b>		<b>10/77-12/87</b>	<b>4 Cyl 1.9L, 2.0L, 2.6L 4G51, 4G52, 4G54</b>
Water Pump	<b>TF1009</b>		
Fan Clutch	<b>TFC117</b>		
<b>Starion JA, JB, JD</b>		<b>5/82-8/87</b>	<b>4 Cyl 2.0L 4G63T</b>
Water Pump	<b>TF3117</b>		
Fan Clutch	<b>TFC125</b>		
<b>Starwagon SF</b>		<b>10/86-10/90</b>	<b>4 Cyl 2.0L 4G63</b>
Water Pump	<b>TF3117</b>	<i>To 5/90 Check Identification Guide</i>	
Water Pump	<b>TF3094</b>	<i>From 5/90 check Identification Guide</i>	
Fan Clutch	<b>TFC125</b>	<i>To 5/90</i>	
<b>Starwagon SF</b>		<b>10/86-10/90</b>	<b>4 Cyl 2.4L 4G64</b>
Water Pump	<b>TF3117</b>		
Fan Clutch	<b>TFC125</b>		

Description	Part No	Year & Notes	Engine
<b>MITSUBISHI</b>			
<b>Starwagon SG</b>		<b>10/90-8/91</b>	<b>4 Cyl 2.0L 4G63</b>
Water Pump	<b>TF3094</b>		
<b>Starwagon SG</b>		<b>10/90-8/91</b>	<b>4 Cyl 2.4L 4G64</b>
Water Pump	<b>TF3117</b>		
Fan Clutch	<b>TFC125</b>	<i>Check Measurements some Models use TFC117</i>	
<b>Starwagon SH</b>		<b>9/91-9/94</b>	<b>4 Cyl 2.0L 4G63</b>
Water Pump	<b>TF3117</b>	<i>To 5/92 Also check Identification Guide for TF8274</i>	
Water Pump	<b>TF4008</b>	<i>From 6/92</i>	
Water Pump	<b>TF8274</b>	<i>Casting has extra cast piece to cover Oil Hole &amp; Pump also has weep hole</i>	
Fan Clutch	<b>TFC125</b>	<i>To 5/92</i>	
Fan Clutch	<b>TFC150</b>	<i>From 6/92</i>	
Timing Belt Kit	<b>TFK104</b>		
<b>Starwagon SH</b>		<b>9/91-9/94</b>	<b>4 Cyl 2.4L 4G64</b>
Water Pump	<b>TF3117</b>		
Fan Clutch	<b>TFC125</b>	<i>Check Measurements some Models use TFC117</i>	
<b>Starwagon SJ,WA</b>		<b>9/95-1/04</b>	<b>4 Cyl 2.0L 4G63</b>
Water Pump	<b>TF4008</b>	<i>Some Models use TF8274 different Pump Casting</i>	
Water Pump	<b>TF8274</b>	<i>Casting has extra cast piece to cover Oil Hole &amp; Pump also has weep hole</i>	
Fan Clutch	<b>TFC150</b>		
Timing Belt Kit	<b>TFK104</b>		
<b>Starwagon WA</b>		<b>9/94-5/04</b>	<b>4 Cyl 2.4L 4G64</b>
Water Pump	<b>TF4008</b>	<i>Some Models use TF8274 different Pump Casting</i>	
Water Pump	<b>TF8274</b>	<i>Casting has extra cast piece to cover Oil Hole &amp; Pump also has weep hole</i>	
Fan Clutch	<b>TFC150</b>		
Timing Belt Kit	<b>TFK123</b>	<i>Kit contains 124 Teeth x 29mm wide Timing Belt</i>	
<b>Starwagon WA</b>		<b>9/94-11/96</b>	<b>V6 3.0L 6G72</b>
Water Pump	<b>TF4018</b>	<i>Pump without Housing</i>	
Water Pump	<b>TF4018H</b>	<i>Pump with Housing</i>	
Fan Clutch	<b>TFC105</b>		
<b>Triton ME, MF, MG Diesel incl. Turbo</b>		<b>10/86-9/90</b>	<b>4 Cyl 2.5L 4D56, 4D56T</b>
Water Pump	<b>TF1032</b>		
Fan Clutch	<b>TFC105</b>		
Heater Valve / Tap	<b>TFT7008</b>		
Timing Belt Kit	<b>TFK080</b>		



Description	Part No	Year & Notes	Engine
<b>MITSUBISHI</b>			
<b>Triton ME, MF, MG</b>			
		<b>10/86-9/90</b>	<b>4 Cyl 2.6L 4G54</b>
Water Pump	<b>TF1009</b>		
Fan Clutch	<b>TFC117</b>		
Heater Valve / Tap	<b>TFT7008</b>		
<b>Triton MH, MJ Diesel</b>			
		<b>9/90-10/96</b>	<b>4 Cyl 2.5L 4D56</b>
Water Pump	<b>TF1032</b>	<i>Models with 2 Bolt Thermostat Flange</i>	
Water Pump	<b>TF3144</b>	<i>Models with 4 Bolt Thermostat Flange</i>	
Fan Clutch	<b>TFC105</b>		
Heater Valve / Tap	<b>TFT7008</b>		
Timing Belt Kit	<b>TFK080</b>	<i>Kit contains 88 Teeth Timing Belt</i>	
Timing Belt Kit	<b>TFK096</b>	<i>Kit contains 99 Teeth Timing Belt</i>	
<b>Triton MH, MJ</b>			
		<b>9/90-10/96</b>	<b>4 Cyl 2.6L 4G54</b>
Water Pump	<b>TF1009</b>		
Fan Clutch	<b>TFC117</b>		
Heater Valve / Tap	<b>TFT7008</b>		
<b>Triton MH, MJ</b>			
		<b>9/90-10/96</b>	<b>V6 3.0L 6G72</b>
Water Pump	<b>TF2040</b>	<i>Pump without Housing 40.5mm OD O-Ring</i>	
Water Pump	<b>TF3114</b>	<i>Pump with Housing</i>	
Fan Clutch	<b>TFC105</b>		
Heater Valve / Tap	<b>TFT7008</b>		
Timing Belt Kit	<b>TFK058</b>		
Timing Belt Kit with Water Pump	<b>TFK058P</b>	<i>Kit contains TF2040 Pump</i>	
Timing Belt Kit with Water Pump	<b>TFK058PC1</b>	<i>Kit contains TF3114 Pump</i>	
<b>Triton MK</b>			
		<b>10/96-4/07</b>	<b>4 Cyl 2.4L 4G64</b>
Water Pump	<b>TF4008</b>		
Fan Clutch	<b>TFC150</b>		
Timing Belt Kit	<b>TFK123</b>		
<b>Triton MK Diesel incl. Turbo</b>			
		<b>1/96-4/07</b>	<b>4 Cyl 2.8L 4M40, 4M40T</b>
Water Pump	<b>TF3115</b>		
Fan Clutch	<b>TFC153</b>		
Timing Chain Kit	<b>TCK106</b>	<i>Single Row Timing Chain</i>	
Timing Chain Kit	<b>TCK107</b>	<i>Double Row Timing Chain</i>	
<b>Triton MK</b>			
		<b>10/96-4/07</b>	<b>V6 3.0L 6G72</b>
Water Pump	<b>TF4018</b>	<i>Pump without Housing</i>	
Water Pump	<b>TF4018H</b>	<i>Pump with Housing</i>	
Fan Clutch	<b>TFC105</b>		
Timing Belt Kit	<b>TFK113</b>		
Timing Belt Kit	<b>TFK113H</b>	<i>Kit contains Hydraulic Tensioner</i>	

Description	Part No	Year & Notes	Engine
<b>MITSUBISHI</b>			
<b>Triton ML</b>			
		4/07-7/09	4 Cyl 2.4L 4G64
Water Pump	TF4008		
Fan Clutch	TFC229		
Radiator Fan Blade	TFB515		
<b>Triton ML Turbo Diesel</b>			
		2/08-7/09	4 Cyl 2.5L 4D56T
Water Pump	TF8486		
Fan Clutch	TFC228		
Radiator Fan Blade	TFB545		
<b>Triton ML Turbo Diesel</b>			
		1/06-7/09	4 Cyl 3.2L 4M41T
Water Pump	TF8332		
Fan Clutch	TFC202		
<b>Triton ML</b>			
		1/06-7/09	V6 3.5L 6G74
Water Pump	TF8189		
Fan Clutch	TFC203		
Timing Belt Kit	TFK128		
Timing Belt Kit	TFK128H	<i>Kit contains Hydraulic Tensioner</i>	
<b>Triton MN Turbo Diesel</b>			
		8/09-on	4 Cyl 2.5L 4D56T
Water Pump	TF8486		
Fan Clutch	TFC228	<i>To 1/10</i>	
Fan Clutch	TFC235	<i>From 2/10</i>	
Radiator Fan Blade	TFB545		
<b>Verada KR, KS</b>			
		8/91-10/97	V6 3.0L 6G72
Water Pump	TF2040	<i>Pump without Housing 40.5mm OD O-Ring</i>	
Water Pump	TF2040H	<i>Pump with Housing</i>	
Timing Belt Kit	TFK058		
Timing Belt Kit with Water Pump	TFK058P	<i>Kit contains TF2040 Pump</i>	
<b>Verada KE, KF, KH, KJ, KL, KW</b>			
		10/96-5/06	V6 3.5L 6G74
Water Pump	TF4014	<i>Pump without Housing</i>	
Water Pump	TF4014H	<i>Pump with Housing</i>	
Timing Belt Kit	TFK099H	<i>Kit contains Hydraulic Tensioner</i>	
Timing Belt Kit with Water Pump	TFK099HP	<i>Kit with Hydraulic Tensioner &amp; TF4014 Pump without Housing</i>	
Timing Belt Kit with Water Pump	TFK099HPC	<i>Kit with Hydraulic Tensioner &amp; TF4014H Pump with Housing</i>	
Timing Belt Kit	TFK099		
Timing Belt Kit with Water Pump	TFK099P	<i>Kit contains TF4014 Pump without Housing</i>	
Timing Belt Kit with Water Pump	TFK099PC	<i>Kit contains TF4014H Pump with Housing</i>	

Description	Part No	Year & Notes	Engine
<b>NISSAN</b>			
<b>520, 620 Ute</b>		<b>1/71-12/79</b>	<b>4 Cyl 1.5L J15</b>
Water Pump	<b>TF837</b>		
<b>720</b>		<b>1/80-12/85</b>	<b>4 Cyl 1.8L L18</b>
Water Pump	<b>TF752</b>		
<b>720</b>		<b>1/80-9/84</b>	<b>4 Cyl 2.2L SD22</b>
Water Pump	<b>TF857</b>		
<b>720</b>		<b>1/85-12/85</b>	<b>4 Cyl 2.2L Z22</b>
Water Pump	<b>TF754</b>		
Fan Clutch	<b>TFC137</b>	<i>Check Measurements some Models use TFC127</i>	
<b>720</b>		<b>6/83-12/85</b>	<b>4 Cyl 2.3L, 2.5L SD23, SD25</b>
Water Pump	<b>TF833</b>		
Fan Clutch	<b>TFC166</b>	<i>Check Measurements some Models use TFC127</i>	
<b>1000, 1200</b>		<b>1967-12/85</b>	<b>4 Cyl 1.0L, 1.2L A10, A12</b>
Water Pump	<b>TF788</b>		
<b>1600</b>		<b>1965-73</b>	<b>4 Cyl 1.6L L16</b>
Water Pump	<b>TF752</b>		
<b>2000, 2300, 2400</b>		<b>1966-8/71</b>	<b>6 Cyl 2.0L G20, L23, L24</b>
Water Pump	<b>TF754</b>		
Fan Clutch	<b>TFC137</b>	<i>Check Measurements some Models use TFC127</i>	
<b>120Y B210</b>		<b>3/74-3/79</b>	<b>4 Cyl 1.2L A12</b>
Water Pump	<b>TF788</b>	<i>Suits Models without Fan Clutch</i>	
<b>180B, 200B</b>		<b>9/72-5/81</b>	<b>4 Cyl 1.8L, 2.0L L18, L20B</b>
Water Pump	<b>TF752</b>	<i>Without Air Conditioning</i>	
<b>180SX</b>		<b>1/88-1/92</b>	<b>4 Cyl 1.8l CA18DE, CA18DET</b>
Water Pump	<b>TF3023</b>		
<b>180SX</b>		<b>1/91-1/98</b>	<b>4 Cyl 2.0L SR20DE, SR20DET</b>
Water Pump	<b>TF8169</b>		
Fan Clutch	<b>TFC214</b>		
<b>200SX</b>		<b>10/94-2/03</b>	<b>4 Cyl 2.0L SR20DET</b>
Water Pump	<b>TF3097</b>		
Fan Clutch	<b>TFC214</b>		

Description	Part No	Year & Notes	Engine
<b>NISSAN</b>			
<b>240C, 240K, 240Z</b>		10/70-3/78	6 Cyl 2.4L L24
Water Pump	TF754		
<b>260C, 260Z, 280C, 280ZX</b>		1/73-5/84	6 Cyl 2.6L, 2.8L L26, L28, L28E
Water Pump	TF754		
<b>300C Y30</b>		5/84-10/86	V6 3.0L VG30E
Water Pump	TF2191		
Fan Clutch	TFC137		
<b>300ZX Z31</b>		5/84-12/89	V6 3.0L VG30E
Water Pump	TF2191		
Fan Clutch	TFC137		
<b>300ZX Z32</b>		12/89-3/97	V6 3.0L VG30DE
Water Pump	TF3098		
Fan Clutch	TFC165		
<b>350Z</b>		2/03-5/10	V6 3.5L VQ35DE
Water Pump	TF8345		
<b>370Z</b>		5/09-on	V6 3.7L VQ37HR
Water Pump	TF8345		
<b>Bluebird Series 1, 2</b>		1981-1/85	4 Cyl 2.0L L20B
Water Pump	TF752	<i>Without Air Conditioning</i>	
<b>Bluebird Series 3</b>		2/85-12/86	4 Cyl 2.0L CA20S
Water Pump	TF3023		
Fan Clutch	TFC134		
<b>Bluebird U13</b>		9/93-12/97	4 Cyl 2.4L KA24DE
Water Pump	TF3099		
<b>Brougham V30E</b>		1986-88	V6 3.0L VG30E
Water Pump	TF2191		
<b>Caball C240, C340</b>		1969-81	4 Cyl 2.0L H20
Water Pump	TF844		
<b>Cabstar F22</b>		4/84-12/87	4 Cyl 2.0L Z20
Water Pump	TF752		

Description	Part No	Year & Notes	Engine
<b>NISSAN</b>			
<b>Cabstar F22 Diesel</b>		<b>1/88-12/92</b>	<b>4 Cyl 2.7L TD27</b>
Water Pump	<b>TF3025</b>	<i>Pump only without Fan Clutch</i>	
Water Pump	<b>TF3119</b>	<i>Pump Complete with Fan Clutch</i>	
Fan Clutch	<b>TFC127</b>		
<b>Cabstar H40</b>		<b>1/83-4/88</b>	<b>4 Cyl 2.2L Z22</b>
Water Pump	<b>TF754</b>		
Fan Clutch	<b>TFC137</b>	<i>Check Measurements some Models use TFC166</i>	
<b>Cabstar H40 Diesel</b>		<b>5/87-1/91</b>	<b>4 Cyl 2.7L TD27</b>
Water Pump	<b>TF3119</b>		
<b>Cabstar H40 Diesel incl. Turbo</b>		<b>1/84-1/94</b>	<b>4 Cyl 3.3L, 3.5L ED33, FD35</b>
Water Pump	<b>TF3026</b>		
<b>Civilian</b>		<b>9/91-7/99</b>	<b>6 Cyl 4.2L TD42</b>
Water Pump	<b>TF3138</b>		
<b>Dualis J10</b>		<b>10/07-on</b>	<b>4 Cyl 2.0L MR20</b>
Water Pump	<b>TF8346</b>		
<b>EXA N13</b>		<b>2/87-10/91</b>	<b>4 Cyl 1.6L, 1.8L CA16DE, CA18DE</b>
Water Pump	<b>TF1170</b>		
<b>Gazelle S12</b>		<b>1/84-12/89</b>	<b>4 Cyl 2.0L CA20E</b>
Water Pump	<b>TF3023</b>		
Fan Clutch	<b>TFC134</b>		
<b>GT-R</b>		<b>1991-93</b>	<b>6 Cyl 2.6L RB26DETT</b>
Water Pump	<b>TF898</b>		
<b>Homer T20</b>		<b>1969-76</b>	<b>4 Cyl 1.6L J16</b>
Water Pump	<b>TF837</b>		
<b>Homer F20</b>		<b>1977-81</b>	<b>4 Cyl 2.0L H20</b>
Water Pump	<b>TF844</b>		
<b>Infiniti Q45</b>		<b>7/93-1/98</b>	<b>V8 4.5L VH45DE</b>
Water Pump	<b>TF8343</b>		
<b>Maxima J30 Sohc</b>		<b>4/90-1/96</b>	<b>V6 3.0L VG30E</b>
Water Pump	<b>TF3024</b>		
Heater Valve / Tap	<b>TFT7005</b>		
Timing Belt Kit	<b>TFK094</b>		



Description	Part No	Year & Notes	Engine
<b>NISSAN</b>			
<b>Maxima A32 Dohc</b>		2/95-12/99	V6 3.0L VQ30DE
Water Pump	TF8167		
<b>Maxima A33 Dohc</b>		12/99-12/03	V6 3.0L VQ30DE
Water Pump	TF8167		
Thermostat & Housing	TTH569		
<b>Maxima J31 Dohc</b>		12/03-7/09	V6 3.5L VQ35DE
Water Pump	TF8345		
Thermostat & Housing	TTH579		
<b>Maxima J32</b>		6/09-on	V6 3.5L VQ35DE
Water Pump	TF8345		
<b>Micra K11E</b>		6/95-12/97	4 Cyl 1.3L CG13DE
Water Pump	TF3101		
<b>Micra K12 Dohc</b>		10/07-on	4 Cyl 1.4L CR14
Water Pump	TF8390		
<b>Micra K13</b>		11/10-on	3 Cyl 1.2L, 1.5L HR12 HR15DE
Water Pump	TF8484		
Water Pump	TF8484		
<b>Murano</b>		1/05-on	V6 3.5L VQ35
Water Pump	TF8345		
Thermostat & Housing	TTH579		
<b>Navara D21</b>		1/86-12/97	4 Cyl 2.0L Z20
Water Pump	TF3058		
<b>Navara D21</b>		1/86-11/92	4 Cyl 2.4L Z24
Water Pump	TF754	<i>With Air Conditioning</i>	
Water Pump	TF752	<i>Without Air Conditioning</i>	
Fan Clutch	TFC127		
<b>Navara D21</b>		1/92-3/98	4 Cyl 2.4L KA24E
Water Pump	TF3118		
Fan Clutch	TFC127		
Timing Chain Kit	TCK108	<i>Single Row Timing Chain</i>	
<b>Navara D21 Diesel</b>		1/86-12/91	4 Cyl 2.5L SD25
Water Pump	TF3027		
Fan Clutch	TFC127		

Description	Part No	Year & Notes	Engine
<b>NISSAN</b>			
<b>Navara D21 Diesel</b>		<b>2/88-5/92</b>	<b>4 Cyl 2.5L TD25</b>
Water Pump	<b>TF3028</b>	<i>Pump &amp; Fan Clutch complete with F/C Bolt Holes 134mm</i>	
<b>Navara D21 Diesel</b>		<b>1/88-12/98</b>	<b>4 Cyl 2.7L TD27</b>
Water Pump	<b>TF3028</b>	<i>To 5/92 Pump &amp; Fan Clutch complete with F/C Bolt Holes 134mm</i>	
Water Pump	<b>TF4130</b>	<i>From 6/92 Pump &amp; Fan Clutch complete with F/C Bolt Holes 143mm</i>	
Radiator Fan Blade	<b>TFB548</b>		
<b>Navara D21</b>		<b>1/92-3/98</b>	<b>V6 3.0L VG30E</b>
Water Pump	<b>TF2191</b>		
Fan Clutch	<b>TFC115</b>		
Timing Belt Kit	<b>TFK094</b>		
<b>Navara D22</b>		<b>3/97-8/99</b>	<b>4 Cyl 2.4L KA24E</b>
Water Pump	<b>TF3118</b>		
Fan Clutch	<b>TFC127</b>		
Timing Chain Kit	<b>TCK108</b>	<i>Single Row Timing Chain</i>	
<b>Navara D22</b>		<b>8/99-12/05</b>	<b>4 Cyl 2.4L KA24DE</b>
Water Pump	<b>TF3118</b>		
Fan Clutch	<b>TFC127</b>		
<b>Navara D22</b>		<b>1/08-on</b>	<b>4 Cyl 2.5L YD25T</b>
Water Pump	<b>TF8371</b>		
<b>Navara D22 Diesel</b>		<b>1/97-12/02</b>	<b>4 Cyl 2.7L TD27</b>
Water Pump	<b>TF4130</b>	<i>Pump &amp; Fan Clutch complete with F/C Bolt Holes 143mm</i>	
Radiator Fan Blade	<b>TFB548</b>		
<b>Navara D22</b>		<b>6/00-12/05</b>	<b>V6 3.0L VG30E</b>
Water Pump	<b>TF2191</b>	<i>RWD Model</i>	
Water Pump	<b>TF3120</b>	<i>4WD Model</i>	
Fan Clutch	<b>TFC115</b>		
Timing Belt Kit	<b>TFK094</b>		
<b>Navara D22</b>		<b>2/03-7/06</b>	<b>V6 3.3L VG33</b>
Water Pump	<b>TF3120</b>		
Fan Clutch	<b>TFC115</b>		
Timing Belt Kit	<b>TFK094</b>		
<b>Navara D22 Turbo Diesel 4WD</b>		<b>12/01-1/08</b>	<b>4 Cyl 3.0L ZD30T</b>
Water Pump	<b>TF8221</b>		

Description	Part No	Year & Notes	Engine
<b>NISSAN</b>			
<b>Navara D22 Diesel</b>			
		3/97-12/01	4 Cyl 3.2L QD32
Water Pump	TF4130	<i>Pump &amp; Fan Clutch complete with F/C Bolt Holes 143mm</i>	
Fan Clutch	TFC189		
<b>Navara D40 Turbo Diesel</b>			
		12/05-on	4 Cyl 2.5L YD25T
Water Pump	TF8371		
Fan Clutch	TFC237		
Timing Chain Kit	TCK111G	<i>Double Row Timing Chain (kit with Gears)</i>	
<b>Navara D40</b>			
		12/05-on	V6 4.0L VQ40DE
Water Pump	TF8345		
Thermostat & Housing	TTH570		
Fan Clutch	TFC215		
Radiator Fan Blade	TFB547		
<b>Nomad GC22</b>			
		12/86-12/94	4 Cyl 2.4L Z24
Water Pump	TF3030		
Fan Clutch	TFC137	<i>To 10/87</i>	
Fan Clutch	TFC134	<i>From 10/87</i>	
<b>NX, NX-R</b>			
		10/91-9/95	4 Cyl 2.0L SR20DE
Water Pump	TF3050		
<b>Pathfinder WNYD21</b>			
		12/86-10/92	4 Cyl 2.4L Z24
Water Pump	TF754		
Fan Clutch	TFC166		
<b>Pathfinder WHYD21</b>			
		9/92-11/95	V6 3.0L VG30E
Water Pump	TF3120		
Fan Clutch	TFC115		
Timing Belt Kit	TFK094		
<b>Pathfinder R50</b>			
		11/95-7/05	V6 3.3L VG33E
Water Pump	TF4011		
Fan Clutch	TFC188		
Timing Belt Kit	TFK094		
<b>Pathfinder R51 Turbo Diesel</b>			
		7/05-on	4 Cyl 2.5L YD25T
Water Pump	TF8371		
Fan Clutch	TFC237		
<b>Pathfinder R51</b>			
		7/05-on	V6 4.0L VQ40DE
Water Pump	TF8345		
Fan Clutch	TFC215		

Description	Part No	Year & Notes	Engine
<b>NISSAN</b>			
<b>Patrol MQ</b>		<b>6/80-1/88</b>	<b>6 Cyl 4.0L P40</b>
Water Pump	<b>TF4021</b>		
<b>Patrol MQ</b>		<b>9/80-12/88</b>	<b>6 Cyl 2.8L L28</b>
Water Pump	<b>TF754</b>		
Fan Clutch	<b>TFC137</b>	<i>To 8/83</i>	
Fan Clutch	<b>TFC166</b>	<i>From 8/83</i>	
<b>Patrol MQ Diesel</b>		<b>6/80-12/87</b>	<b>6 Cyl 3.3L SD33</b>
Water Pump	<b>TF913</b>		
Fan Clutch	<b>TFC110</b>	<i>Suits Non Turbo Model</i>	
Fan Clutch	<b>TFC111</b>	<i>Suits Turbo Model</i>	
<b>Patrol GQ Turbo Diesel</b>		<b>1/94-12/97</b>	<b>6 Cyl 2.8L RD28T</b>
Water Pump	<b>TF6090</b>		
Fan Clutch	<b>TFC164</b>		
Timing Belt Kit	<b>TFK147</b>		
<b>Patrol GQ</b>		<b>7/89-12/97</b>	<b>6 Cyl 3.0L RB30</b>
Water Pump	<b>TF6071</b>		
Fan Clutch	<b>TFC137</b>		
Timing Belt Kit	<b>TFK028</b>		
<b>Patrol GQ</b>		<b>2/88-12/97</b>	<b>6 Cyl 4.2L TB42S</b>
Water Pump	<b>TF5010</b>		
Fan Clutch	<b>TFC138</b>	<i>To 10/91</i>	
Fan Clutch	<b>TFC139</b>	<i>From 11/91</i>	
<b>Patrol GQ</b>		<b>2/88-12/97</b>	<b>6 Cyl 4.2L TB42E</b>
Water Pump	<b>TF5010</b>		
Fan Clutch	<b>TFC167</b>		
<b>Patrol GQ Diesel</b>		<b>1/88-12/99</b>	<b>6 Cyl 4.2L TD42</b>
Water Pump	<b>TF6056</b>		
Fan Clutch	<b>TFC111</b>		
Radiator Fan Blade	<b>TFB528</b>		
<b>Patrol GU Turbo Diesel</b>		<b>12/97-4/01</b>	<b>6 Cyl 2.8L RD28ET</b>
Water Pump	<b>TF6090</b>		
Fan Clutch	<b>TFC164</b>		
<b>Patrol GU Turbo Diesel</b>		<b>4/00-on</b>	<b>4 Cyl 3.0L ZD30T</b>
Water Pump	<b>TF8221</b>	<i>To 1/07 Complete Pump and Fan Clutch</i>	

Description	Part No	Year & Notes	Engine
<b>NISSAN</b>			
<b>Patrol GU Diesel incl. Turbo</b>		<b>4/98-4/07</b>	<b>6 Cyl 4.2L TD42,TD42T</b>
Water Pump	<b>TF6056</b>		
Fan Clutch	<b>TFC111</b>	<i>Suits Non Turbo Model</i>	
Fan Clutch	<b>TFC167</b>	<i>Suits Turbo Model</i>	
<b>Patrol GU</b>		<b>12/97-10/01</b>	<b>6 Cyl 4.5L TB45E</b>
Water Pump	<b>TF4064</b>		
Fan Clutch	<b>TFC167</b>		
<b>Patrol GU</b>		<b>10/01-on</b>	<b>6 Cyl 4.8L TB48E</b>
Water Pump	<b>TF8223</b>		
<b>Pintara R31, U12</b>		<b>1/86-10/93</b>	<b>4 Cyl 2.0L CA20E</b>
Water Pump	<b>TF3023</b>		
Fan Clutch	<b>TFC134</b>		
<b>Pintara U12</b>		<b>1/89-4/93</b>	<b>4 Cyl 2.4L KA24</b>
Water Pump	<b>TF3022</b>		
<b>Prairie M10</b>		<b>12/82-12/88</b>	<b>4 Cyl 1.5L E15</b>
Water Pump	<b>TF888</b>		
<b>Pulsar N10</b>		<b>10/80-12/82</b>	<b>4 Cyl 1.3L, 1.5 E13, E15</b>
Water Pump	<b>TF888</b>		
<b>Pulsar N10</b>		<b>10/80-12/82</b>	<b>4 Cyl 1.4L A14</b>
Water Pump	<b>TF788</b>		
<b>Pulsar N12 incl. Turbo</b>		<b>10/81-12/88</b>	<b>4 Cyl 1.3L, 1.5L, 1.6L E13, E15, E16</b>
Water Pump	<b>TF888</b>		
<b>Pulsar N13</b>		<b>7/87-9/91</b>	<b>4 Cyl 1.6L, 1.8L 16LF, 18LF</b>
Water Pump	<b>TF2189</b>	<i>To 2/90 Pump without Dust Shield</i>	
Water Pump	<b>TF2512</b>	<i>From 2/90 Pump with Dust Shield</i>	
Thermostat & Housing	<b>TTH502</b>		
<b>Pulsar N14, N15</b>		<b>10/91-7/00</b>	<b>4 Cyl 1.6L GA16DE</b>
Water Pump	<b>TF3053</b>		
<b>Pulsar N14, N15</b>		<b>10/91-7/00</b>	<b>4 Cyl 2.0L SR20DE</b>
Water Pump	<b>TF3050</b>		
<b>Pulsar N16</b>		<b>7/00-2/06</b>	<b>4 Cyl 1.6L, 1.8L QG16DE, QG18DE</b>
Water Pump	<b>TF8168</b>		



Description	Part No	Year & Notes	Engine
<b>NISSAN</b>			
<b>Serena C23</b>		9/92-2/96	4 Cyl 2.0L SR20DE
Water Pump	TF3050		
<b>Silvia S13 Imported</b>		1/90-12/00	4 Cyl 2.0L SR20DET
Water Pump	TF8169		
<b>Skyline C210, R30</b>		3/78-6/86	6 Cyl 2.4L L24, L24E
Water Pump	TF754		
Fan Clutch	TFC166		
<b>Skyline R31</b>		7/86-12/90	6 Cyl 3.0L RB30E
Water Pump	TF898		
Fan Clutch	TFC137	<i>136mm Centre to Centre suits Australian Production Model</i>	
Timing Belt Kit	TFK028		
<b>Skyline HR32 RWD</b>		1/89-9/93	6 Cyl 2.0L RB20E, RB20DET
Water Pump	TF8372		
<b>Skyline HR32 AWD</b>		1/89-3/94	6 Cyl 2.6L RB26DETT
Water Pump	TF8372		
Timing Belt Kit	TFK173		
<b>Skyline R33 RWD</b>		1/93-12/98	6 Cyl 2.5L RB25DE, RB25DET
Water Pump	TF8372		
Timing Belt Kit	TFK173		
<b>Skyline HR33 AWD</b>		1/93-12/98	6 Cyl 2.6L RB26DETT
Water Pump	TF8372		
Timing Belt Kit	TFK173		
<b>Skyline R34 RWD</b>		11/98-12/00	6 Cyl 2.5L RB25DET
Water Pump	TF8372		
Timing Belt Kit	TFK173		
<b>Skyline HR34 AWD</b>		1/93-12/98	6 Cyl 2.6L RB26DETT
Water Pump	TF8372		
Timing Belt Kit	TFK173		
<b>Skyline PV35</b>		1/01-1/07	V6 3.5L VQ35DE
Water Pump	TF8345		
<b>ST Utility XFN</b>		7/88-9/92	6 Cyl 4.1L
Water Pump	TF804		

Description	Part No	Year & Notes	Engine
<b>NISSAN</b>			
<b>Stanza A10</b>		10/78-9/83	4 Cyl 1.6L L16
Water Pump	TF752		
<b>Sunny B310</b>		3/79-12/83	4 Cyl 1.2L, 1.4L, 1.5L A12, A14, A15
Water Pump	TF788	<i>Suits Models without Fan Clutch</i>	
<b>Terrano II R20</b>		3/97-4/00	4 Cyl 2.4L KA24E
Water Pump	TF3118		
Fan Clutch	TFC127		
<b>Terrano II R20 Turbo Diesel</b>		3/97-4/00	4 Cyl 2.7L TD27Ti
Water Pump	TF4130		
<b>Tiida C11</b>		2/06-on	4 Cyl 1.8L MR18
Water Pump	TF8346		
<b>Urvan E20</b>		1976-80	4 Cyl 2.0L H20
Water Pump	TF844		
<b>Urvan E23</b>		1980-82	4 Cyl 1.6L J16
Water Pump	TF837		
<b>Urvan E23</b>		9/82-12/83	4 Cyl 2.0L H20
Water Pump	TF846		
<b>Urvan E23</b>		1/81-12/86	4 Cyl 2.0L Z20
Water Pump	TF754		
Fan Clutch	TFC137	<i>Check Measurements some Models use TFC127</i>	
<b>Urvan E23 Diesel</b>		11/80-12/86	4 Cyl 2.2L, 2.3L SD22, SD23
Water Pump	TF857		
<b>Urvan E24</b>		1/87-9/93	4 Cyl 2.4L Z24
Water Pump	TF754		
Fan Clutch	TFC137	<i>Check Measurements some Models use TFC127</i>	
<b>Urvan E24 Diesel</b>		3/87-9/93	4 Cyl 2.7L TD27
Water Pump	TF3025	<i>Pump only without Fan Clutch</i>	
Water Pump	TF3119	<i>Pump Complete with Fan Clutch</i>	
Fan Clutch	TFC127		
<b>Vanette C20</b>		5/83-12/90	4 Cyl 1.2L A12
Water Pump	TF788	<i>Suits Models without Fan Clutch</i>	

Description	Part No	Year & Notes	Engine
<b>NISSAN</b>			
<b>Vanette</b>			
		12/86-12/93	4 Cyl 2.0L Z20
Water Pump	TF754		
Fan Clutch	TFC137	<i>Check Measurements some Models use TFC127</i>	
<b>X-Trail T31 Diesel</b>			
		7/08-on	4 Cyl 2.0L MR9, MR20
Water Pump	TF8452		
<b>X-Trail T30</b>			
		10/01-12/07	4 Cyl 2.5L QR25
Water Pump	TF8267		
Timing Chain Kit	TCK110G	<i>Kit with Gears</i>	
<b>X-Trail T31</b>			
		10/07-on	4 Cyl 2.5L QR25
Water Pump	TF8267		
<b>PEUGEOT</b>			
<b>205</b>			
		1/84-4/94	4 Cyl 1.6L XU5M3
Water Pump	TF4028		
<b>205 GTi</b>			
		10/87-12/94	4 Cyl 1.9L XU9JA
Water Pump	TF3141	<i>To 11/91</i>	
Water Pump	TF4028	<i>From 12/91</i>	
<b>206</b>			
		3/02-3/07	4 Cyl 1.4L TU3JP4
Water Pump	TF8235	<i>To Engine No. M3666765 20 Teeth Pulley</i>	
Water Pump	TF8330	<i>From Engine No. M3666765 18 Teeth Pulley</i>	
Thermostat & Housing	TTH503	<i>To Chassis No. 10401</i>	
Thermostat & Housing	TTH532	<i>From Chassis No. 10402</i>	
<b>206 Sohc</b>			
		10/99-2/02	4 Cyl 1.6L TU5JP
Water Pump	TF8100		
<b>206 Dohc</b>			
		2/01-2/08	4 Cyl 1.6L TU5JP4
Water Pump	TF8136		
Thermostat & Housing	TTH503	<i>To Chassis No. 10401</i>	
Thermostat & Housing	TTH532	<i>From Chassis No. 10402</i>	
<b>206 GTi 2</b>			
		10/99-7/07	4 Cyl 2.0L EW10J4
Water Pump	TF8138	<i>Without Housing 55mm impeller</i>	
Water Pump	TF8430	<i>With Housing</i>	
<b>206</b>			
		10/99-7/07	4 Cyl 2.0L EW10J4
Thermostat & Housing	TTH512		

Description	Part No	Year & Notes	Engine
<b>PEUGEOT</b>			
<b>207 3 Door 55kW</b>		<b>3/07-on</b>	<b>4 Cyl 1.4L ET3</b>
Water Pump	<b>TF8330</b>	<i>20 Teeth Spline</i>	
<b>207 5 Door 65kW</b>		<b>3/07-on</b>	<b>4 Cyl 1.4L ET3</b>
Water Pump	<b>TF8383</b>	<i>18 Teeth Spline</i>	
<b>306 Sohc</b>		<b>4/94-8/99</b>	<b>4 Cyl 1.8L XU7JP</b>
Water Pump	<b>TF8401</b>		
<b>306 Turbo Diesel</b>		<b>4/96-4/00</b>	<b>4 Cyl 1.9L XUD9</b>
Water Pump	<b>TF8401</b>		
<b>306</b>		<b>7/94-11/03</b>	<b>4 Cyl 2.0L XU10J2, XU10J4R</b>
Water Pump	<b>TF8401</b>		
<b>306 Turbo Diesel</b>		<b>4/00-12/01</b>	<b>4 Cyl 2.0L DW10TD</b>
Water Pump	<b>TF8137</b>		
<b>307</b>		<b>12/01-2/09</b>	<b>4 Cyl 1.6L TU5JP4</b>
Water Pump	<b>TF8136</b>		
Thermostat & Housing	<b>TTH503</b>	<i>To Chassis No. 10436</i>	
Thermostat & Housing	<b>TTH532</b>	<i>From Chassis No. 10437</i>	
<b>307 Turbo Diesel</b>		<b>3/05-2/09</b>	<b>4 Cyl 1.6L DV6TED4</b>
Water Pump	<b>TF8417</b>		
Thermostat & Housing	<b>TTH541</b>		
<b>307</b>		<b>12/01-2/09</b>	<b>4 Cyl 2.0L EW10J4, EW10J4S</b>
Water Pump	<b>TF8138</b>	<i>To 4/06 &amp; To Vin No. M02575379 Plastic Pump without Housing 55mm impeller</i>	
Water Pump	<b>TF8328</b>	<i>From 5/06 &amp; To Vin No. M02575380 Plastic without Housing 61mm impeller</i>	
Water Pump	<b>TF8482</b>	<i>Alloy Pump without Housing 64mm impeller</i>	
Water Pump	<b>TF8430</b>	<i>All Pump types complete Housing</i>	
Thermostat & Housing	<b>TTH512</b>		
<b>307 Turbo Diesel</b>		<b>12/01-10/05</b>	<b>4 Cyl 2.0L DW10</b>
Water Pump	<b>TF8137</b>		
Thermostat & Housing	<b>TTH512</b>		
<b>307 Turbo Diesel</b>		<b>11/05-2/09</b>	<b>4 Cyl 2.0L DW10BTED4</b>
Water Pump	<b>TF8382</b>		
Thermostat & Housing	<b>TTH512</b>		

Description	Part No	Year & Notes	Engine
<b>PEUGEOT</b>			
<b>308 T7 Turbo Diesel</b>		<b>2/08-on</b>	<b>4 Cyl 2.0L DW10BTED4</b>
Water Pump	<b>TF8382</b>		
Thermostat & Housing	<b>TTH543</b>		
<b>405</b>		<b>1/88-12/92</b>	<b>4 Cyl 1.9L XU9J4</b>
Water Pump	<b>TF3141</b>		
<b>405</b>		<b>5/93-5/96</b>	<b>4 Cyl 2.0L XU10J2, XU10J4</b>
Water Pump	<b>TF4028</b>		
<b>406 Petrol</b>		<b>9/96-9/04</b>	<b>4 Cyl 2.0L XU10J4R</b>
Water Pump	<b>TF8101</b>		
<b>406 Turbo Diesel</b>		<b>9/96-9/04</b>	<b>4 Cyl 2.0L DW10ATED</b>
Water Pump	<b>TF8137</b>		
Thermostat & Housing	<b>TTH512</b>		
<b>407 Turbo Diesel</b>		<b>9/04-5/07</b>	<b>4 Cyl 2.0L DW10BTED4</b>
Water Pump	<b>TF8328</b>	<i>Plastic Pump without Housing 61mm impeller</i>	
Water Pump	<b>TF8482</b>	<i>Alloy Pump without Housing 64mm impeller</i>	
Water Pump	<b>TF8430</b>	<i>All Pump types complete with Housing</i>	
Thermostat & Housing	<b>TTH543</b>		
Thermostat Repair Kit	<b>TTH595</b>		
<b>407</b>		<b>9/04-9/09</b>	<b>4 Cyl 2.2L EW12J4</b>
Water Pump	<b>TF8328</b>	<i>Plastic Pump without Housing 61mm impeller</i>	
Water Pump	<b>TF8482</b>	<i>Alloy Pump without Housing 64mm impeller</i>	
Water Pump	<b>TF8430</b>	<i>All Pump types complete with Housing</i>	
Thermostat & Housing	<b>TTH512</b>		
<b>407</b>		<b>9/04-on</b>	<b>V6 2.7L, 2.9L DW17, ES9</b>
Water Pump	<b>TF8329</b>		
<b>4007 Turbo Diesel</b>		<b>11/09-on</b>	<b>4 Cyl 2.2L DW12MTED4</b>
Water Pump	<b>TF8429</b>		
Thermostat & Housing	<b>TTH542</b>		
<b>607</b>		<b>11/01-4/09</b>	<b>V6 3.0L ES9</b>
Water Pump	<b>TF8329</b>		



Description	Part No	Year & Notes	Engine
<b>PROTON</b>			
<b>Gen 2</b>		10/04-on	4 Cyl 1.6L S4PH
<i>Water Pump</i>	<b>TF8407</b>		
<b>M21</b>		10/97-11/00	4 Cyl 1.8L 4G93
<i>Water Pump</i>	<b>TF3092</b>		
<b>Persona</b>		11/96-6/02	4 Cyl 1.3L, 1.5L 4G13, 4G15
<i>Water Pump</i>	<b>TF877</b>		
<b>Persona</b>		11/96-2/01	4 Cyl 1.6L 4G92
<i>Water Pump</i>	<b>TF3092</b>		
<b>Satria</b>		2/97-1/05	4 Cyl 1.3L, 1.5L 4G13, 4G15
<i>Water Pump</i>	<b>TF877</b>		
<i>Timing Belt Kit</i>	<b>TFK003</b>		
<b>Satria</b>		2/97-1/05	4 Cyl 1.6L, 1.8L 4G92, 4G93
<i>Water Pump</i>	<b>TF3092</b>		
<b>Savvy</b>		2/06-on	4 Cyl 1.1L D4F
<i>Water Pump</i>	<b>TF8408</b>		
<b>Waja</b>		12/01-7/06	4 Cyl 1.6L 4G18
<i>Water Pump</i>	<b>TF4108</b>		
<b>Wira</b>		5/95-11/96	4 Cyl 1.5L 4G15
<i>Water Pump</i>	<b>TF877</b>		
<i>Timing Belt Kit</i>	<b>TFK003</b>		
<b>Wira</b>		5/95-11/96	4 Cyl 1.6L 4G92
<i>Water Pump</i>	<b>TF3092</b>		
<b>RENAULT</b>			
<b>Clio</b>		12/01-8/07	4 Cyl 1.4L, 1.6L K4J, K4M
<i>Water Pump</i>	<b>TF8254</b>		
<b>Clio</b>		5/01-11/06	4 Cyl 2.0L F4R
<i>Water Pump</i>	<b>TF8236</b>		
<b>Kangoo</b>		8/04-on	4 Cyl 1.6L K4M
<i>Water Pump</i>	<b>TF8254</b>		

Description	Part No	Year & Notes	Engine
<b>RENAULT</b>			
<b>Koleos</b>		10/08-on	4 Cyl 2.0L M9R
Water Pump	TF8236		
<b>Laguna</b>		5/95-11/04	4 Cyl 2.0L F3R, F4R
Water Pump	TF8236		
<b>Laguna</b>		11/06-11/08	4 Cyl 2.2L
Water Pump	TF8361		
<b>Laguna Sohc</b>		5/95-7/96	V6 3.0L Z7X
Water Pump	TF8248		
<b>Laguna Dohc</b>		8/02-5/06	V6 2.9L L7X
Water Pump	TF8329		
<b>Master Turbo Diesel</b>		8/04-on	4 Cyl 2.5L G9U
Water Pump	TF8361		
<b>Megane</b>		5/01-9/04	4 Cyl 1.6L K4M
Water Pump	TF8254		
<b>Megane</b>		10/04-4/09	4 Cyl 2.0L F4R, F4RT
Water Pump	TF8307		
Thermostat & Housing	TTH512		
<b>R19</b>		9/91-7/96	4 Cyl 1.7L, 1.8L F3N, F3P
Water Pump	TF8236		
<b>Scenic</b>		5/01-9/02	4 Cyl 1.6L K4MA
Water Pump	TF8254		
<b>Scenic</b>		5/01-3/09	4 Cyl 2.0L F4R
Water Pump	TF8236	To 1/07	
Water Pump	TF8307	From 1/07 Phase II	
<b>Trafic</b>		3/04-3/07	4 Cyl 1.9L C22
Water Pump	TF8307		

Description	Part No	Year & Notes	Engine
<b>ROVER</b>			
<b>75</b>		7/04-on	4 Cyl 2.0L
Water Pump	TF8290		
<b>75</b>		3/01-on	V6 2.5L KV6
Water Pump	TF8256		
<b>825Si, 827Si</b>		9/87-1/92	V6 2.5L, 2.7L C25A1, C27A1
Water Pump	TF2025		
<b>Quintet</b>		5/83-3/86	4 Cyl 1.6L EL
Water Pump	TF855	<i>From Engine No.1200001 with 45mm hub</i>	
<b>Range Rover Sport Turbo Diesel</b>		8/05-1/09	V6 2.7L ELD11
Water Pump	TF8410		
<b>Range Rover HSE Turbo Diesel</b>		8/02-on	6 Cyl 3.0L 306D
Water Pump	TF8381		
Thermostat & Housing	TTH548		
<b>Range Rover Petrol</b>		2/86-1/89	V8 3.5L 22D
Water Pump	TF2614		
<b>Range Rover Petrol</b>		1/90-1/92	V8 3.9L 37D, 38D
Water Pump	TF2614		
<b>Range Rover Petrol</b>		1/93-1/95	V8 3.9L 37D, 38D
Water Pump	TF8271		
<b>Range Rover Petrol</b>		5/95-2/02	V8 4.0L 44D
Water Pump	TF8271		
<b>Range Rover A32A</b>		8/02-8/05	V8 4.4L 448S2
Water Pump	TF8258		
<b>Range Rover Sport, Vogue Petrol</b>		8/05-9/09	V8 4.4L M62
Water Pump	TF8258		
<b>Range Rover Petrol</b>		5/95-1/02	V8 4.6L 48D, 59D
Water Pump	TF8271		

Description	Part No	Year & Notes	Engine
<b>SAAB</b>			
<b>9-3 Turbo Diesel</b>		1/07-on	4 Cyl 1.9L Z19DTH
<i>Water Pump</i>	<b>TF8172</b>		
<b>9-3 incl. Turbo</b>		6/98-12/05	4 Cyl 2.0L B204, B205
<i>Water Pump</i>	<b>TF8248</b>		
<b>9-3 Turbo</b>		10/03-12/05	4 Cyl 2.0L B207
<i>Water Pump</i>	<b>TF8259</b>		
<b>9-3 incl. Turbo</b>		8/99-2/01	4 Cyl 2.3L B235
<i>Water Pump</i>	<b>TF8248</b>		
<b>9-3 Turbo</b>		1/06-11/07	V6 2.8L B284
<i>Water Pump</i>	<b>TF5000</b>		
<b>9-5 incl. Turbo</b>		6/98-10/02	4 Cyl 2.0L B204
<i>Water Pump</i>	<b>TF8248</b>		
<b>9-5 Turbo</b>		11/97-11/07	4 Cyl 2.3L B234, B235
<i>Water Pump</i>	<b>TF8248</b>		
<b>9-5</b>		2/99-11/01	V6 3.0L B308
<i>Water Pump</i>	<b>TF8111</b>		
<b>900</b>		2/94-6/98	4 Cyl 2.3L B258
<i>Water Pump</i>	<b>TF2962</b>		
<b>900</b>		2/94-3/98	V6 2.5L B258
<i>Water Pump</i>	<b>TF8111</b>		
<b>900i</b>		11/84-11/94	4 Cyl 2.0L B201, B204
<i>Water Pump</i>	<b>TF2663</b>		
<b>9000 incl. Turbo</b>		1/87-2/92	4 Cyl 2.0L B204
<i>Water Pump</i>	<b>TF2663</b>		
<b>9000 Turbo</b>		3/91-3/98	4 Cyl 2.3L B234
<i>Water Pump</i>	<b>TF2962</b>		
<b>9000</b>		4/90-3/96	4 Cyl 2.3L B258
<i>Water Pump</i>	<b>TF2962</b>		
<b>9000</b>		2/95-3/97	V6 3.0L B308
<i>Water Pump</i>	<b>TF8111</b>		

Description	Part No	Year & Notes	Engine
<b>SEAT</b>			
<b>Cordoba SE</b>		9/98-10/99	4 Cyl 1.6L AEE
<i>Water Pump</i>	<b>TF8128</b>		
<i>Thermostat &amp; Housing</i>	<b>TTH520</b>		
<b>Cordoba SXE</b>		9/98-10/99	4 Cyl 1.6L AFT
<i>Water Pump</i>	<b>TF2453</b>		
<b>Cordoba</b>		1/95-10/99	4 Cyl 1.8L ABS, ADZ
<i>Water Pump</i>	<b>TF2453</b>		
<b>Ibiza</b>		1/95-10/99	4 Cyl 2.0L ABF, 2E
<i>Water Pump</i>	<b>TF2453</b>		
<b>Toledo</b>		1/95-10/99	4 Cyl 2.0L 2E
<i>Water Pump</i>	<b>TF2453</b>		
<b>SKODA</b>			
<b>Octavia Elegance</b>		10/07-on	4 Cyl 2.0L BKD
<i>Water Pump</i>	<b>TF8402</b>		
<b>Octavia</b>		3/09-on	4 Cyl 1.8L BYT, BZB
<i>Water Pump</i>	<b>TF8456</b>		
<i>Thermostat Repair Kit &amp; Housing</i>	<b>TTH585</b>		
<b>Superb 3T</b>		3/09-on	4 Cyl 1.8L CDA
<i>Water Pump</i>	<b>TF8456</b>		
<i>Thermostat Repair Kit &amp; Housing</i>	<b>TTH585</b>		
<b>SSANGYONG</b>			
<b>Chairman</b>		8/05-9/07	6 Cyl 3.2L M104
<i>Water Pump</i>	<b>TF8301</b>		
<b>Korando</b>		2/04-1/06	5 Cyl 2.9L M602
<i>Water Pump</i>	<b>TF8305</b>	<i>Pump without Housing</i>	
<i>Water Pump</i>	<b>TF8499</b>	<i>Pump with Housing</i>	
<b>Kyron Turbo Diesel</b>		6/06-on	V6 2.0L, 2.7L 6649, OM665
<i>Water Pump</i>	<b>TF8306</b>		
<b>Musso</b>		2/04-9/07	5 Cyl 2.9L 6629
<i>Water Pump</i>	<b>TF8305</b>	<i>Pump without Housing</i>	
<i>Water Pump</i>	<b>TF8499</b>	<i>Pump with Housing</i>	



Description	Part No	Year & Notes	Engine
<b>SSANGYONG</b>			
<b>Musso</b>		<b>7/96-8/98</b>	<b>6 Cyl 3.2L IL63200</b>
Water Pump	<b>TF8241</b>		
<b>Rexton RX270 Turbo Diesel</b>		<b>2/04-on</b>	<b>5 Cyl 2.7L OM665</b>
Water Pump	<b>TF8306</b>	<i>To 12/05</i>	
Water Pump	<b>TF8500</b>	<i>From 1/06</i>	
<b>Rexton RX290 Turbo Diesel</b>		<b>6/03-1/05</b>	<b>5 Cyl 2.9L 6629</b>
Water Pump	<b>TF8305</b>	<i>Pump without Housing</i>	
Water Pump	<b>TF8499</b>	<i>Pump with Housing</i>	
<b>Rexton RX320</b>		<b>6/03-5/06</b>	<b>6 Cyl 3.2L 161975</b>
Water Pump	<b>TF8336</b>	<i>Pump with Housing</i>	
<b>Stavic SV270 Turbo Diesel</b>		<b>3/05-on</b>	<b>5 Cyl 2.7L 6659</b>
Water Pump	<b>TF8306</b>		
<b>Stavic SV320</b>		<b>11/05-3/07</b>	<b>V6 3.2L QM665</b>
Water Pump	<b>TF8336</b>	<i>Pump with Housing</i>	
<b>SUBARU</b>			
<b>Brumby</b>		<b>10/80-3/94</b>	<b>4 Cyl 1.8L EA81</b>
Water Pump	<b>TF848</b>		
<b>DL</b>		<b>10/80-12/95</b>	<b>4 Cyl 1.8L EA81, EA82</b>
Water Pump	<b>TF848</b>	<i>To 11/84 EA81 Engine Code</i>	
Water Pump	<b>TF3033</b>	<i>From 12/84 EA82 Engine Code</i>	
<b>Forester incl. Turbo</b>		<b>8/97-7/02</b>	<b>4 Cyl 2.0L EJ20E, EJ20T</b>
Water Pump	<b>TF3035</b>	<i>Single Outlet confirm Thermostat Housing with image</i>	
Water Pump	<b>TF3067</b>	<i>Single Outlet confirm Thermostat Housing with image</i>	
Timing Belt Kit	<b>TFK160H</b>	<i>Kit contains Hydraulic Tensioner</i>	
Timing Belt Kit with Water Pump	<b>TFK160HP</b>	<i>Kit contains Hydraulic Tensioner &amp; kit contains TF3035 Pump</i>	
Timing Belt Kit with Water Pump	<b>TFK160HP1</b>	<i>Kit contains Hydraulic Tensioner &amp; TF3067 Pump</i>	
<b>Forester Sohc</b>		<b>7/02-on</b>	<b>4 Cyl 2.5L EJ25</b>
Water Pump	<b>TF3035</b>	<i>Single Outlet confirm Thermostat Housing with image</i>	
Water Pump	<b>TF3067</b>	<i>Single Outlet confirm Thermostat Housing with image</i>	
Timing Belt Kit	<b>TFK160H</b>	<i>Kit contains Hydraulic Tensioner</i>	
Timing Belt Kit with Water Pump	<b>TFK160HP</b>	<i>Kit contains Hydraulic Tensioner &amp; kit contains TF3035 Pump</i>	

Description	Part No	Year & Notes	Engine
<b>SUBARU</b>			
<b>Forester Dohc Turbo</b>			
		<b>8/03-on</b>	<b>4 Cyl 2.5L EJ25T</b>
Water Pump	<b>TF3091</b>		
Timing Belt Kit	<b>TFK161H</b>	<i>Kit contains Hydraulic Tensioner</i>	
Timing Belt Kit with Water Pump	<b>TFK160HP1</b>	<i>Kit contains TF3067 Pump</i>	
<b>GL</b>			
		<b>6/82-6/90</b>	<b>4 Cyl 1.8L EA82</b>
Water Pump	<b>TF848</b>	<i>To 11/84</i>	
Water Pump	<b>TF3033</b>	<i>From 12/84</i>	
<b>Impreza GC, GF Sohc</b>			
		<b>4/93-12/98</b>	<b>4 Cyl 1.6L, 1.8L EJ16, EJ18</b>
Water Pump	<b>TF3035</b>	<i>Single Outlet</i>	
Timing Belt Kit	<b>TFK075</b>		
Timing Belt Kit	<b>TFK075H</b>	<i>Kit contains Hydraulic Tensioner</i>	
Timing Belt Kit with Water Pump	<b>TFK075HP</b>	<i>Kit contains Hydraulic Tensioner &amp; kit contains TF3035 Pump</i>	
<b>Impreza GC, GF Sohc</b>			
		<b>5/96-12/00</b>	<b>4 Cyl 2.0L EJ20</b>
Water Pump	<b>TF3035</b>	<i>Single Outlet (confirm Thermostat Housing with image)</i>	
Water Pump	<b>TF3067</b>	<i>Single Outlet (confirm Thermostat Housing with image)</i>	
Timing Belt Kit	<b>TFK160H</b>	<i>Kit contains Hydraulic Tensioner</i>	
Timing Belt Kit with Water Pump	<b>TFK160HP</b>	<i>Kit contains Hydraulic Tensioner &amp; kit contains TF3035 Pump</i>	
Timing Belt Kit with Water Pump	<b>TFK160HP1</b>	<i>Kit contains Hydraulic Tensioner &amp; TF3067 Pump</i>	
<b>Impreza GD</b>			
		<b>10/00-7/09</b>	<b>4 Cyl 2.0L EJ20</b>
Water Pump	<b>TF3035</b>	<i>Single Outlet- SOHC Model</i>	
Water Pump	<b>TF8492</b>	<i>Dual Outlet- Dohc Model</i>	
<b>Impreza GE, GH Dohc</b>			
		<b>1/07-on</b>	<b>4 Cyl 2.0L EJ20</b>
Water Pump	<b>TF3067</b>	<i>Single Outlet</i>	
Timing Belt Kit	<b>TFK161H</b>	<i>Kit contains Hydraulic Tensioner</i>	
<b>Impreza GD, GG Sohc</b>			
		<b>10/01-9/05</b>	<b>4 Cyl 2.5L EJ25</b>
Water Pump	<b>TF3035</b>	<i>Single Outlet</i>	
Timing Belt Kit	<b>TFK160H</b>	<i>Kit contains Hydraulic Tensioner</i>	
Timing Belt Kit with Water Pump	<b>TFK160HP</b>	<i>Kit contains Hydraulic Tensioner &amp; kit contains TF3035 Pump</i>	
<b>Impreza WRX GC, GD, GF, GG Dohc Turbo</b>			
		<b>2/94-9/05</b>	<b>4 Cyl 2.0L EJ20T, EJ205T</b>
Water Pump	<b>TF3091</b>	<i>Triple Outlet</i>	
Timing Belt Kit	<b>TFK161H</b>	<i>Kit contains Hydraulic Tensioner</i>	
<b>Impreza WRX Dohc Turbo</b>			
		<b>9/05-on</b>	<b>4 Cyl 2.5L EJ25T</b>
Water Pump	<b>TF3091</b>	<i>Triple Outlet</i>	
Timing Belt Kit	<b>TFK161H</b>	<i>Kit contains Hydraulic Tensioner</i>	

Description	Part No	Year & Notes	Engine
<b>SUBARU</b>			
<b>Leone</b>			
		11/79-8/88	4 Cyl 1.8L EA81
Water Pump	TF848		
<b>Liberty Sohc</b>			
		10/98-7/05	4 Cyl 2.0L EJ20E
Water Pump	TF3035	<i>Single Outlet (confirm Thermostat Housing with image)</i>	
Water Pump	TF3067	<i>Single Outlet (confirm Thermostat Housing with image)</i>	
Timing Belt Kit	TFK160H	<i>Kit contains Hydraulic Tensioner</i>	
Timing Belt Kit with Water Pump	TFK160HP	<i>Kit contains Hydraulic Tensioner &amp; kit contains TF3035 Pump</i>	
Timing Belt Kit with Water Pump	TFK160HP1	<i>Kit contains Hydraulic Tensioner &amp; TF3067 Pump</i>	
<b>Liberty incl.Turbo Dohc</b>			
		9/91-8/07	4 Cyl 2.0L EJ20, EJ20T
Water Pump	TF3091	<i>Triple Outlet</i>	
<b>Liberty incl.Turbo</b>			
		9/03-8/07	4 Cyl 2.0L EJ20, EJ20T
Water Pump	TF8492	<i>Dual Outlet</i>	
<b>Liberty Sohc</b>			
		10/89-2/00	4 Cyl 2.2L EJ22
Water Pump	TF3035	<i>Single Outlet</i>	
Timing Belt Kit	TFK075	<i>To 12/96</i>	
Timing Belt Kit	TFK075H	<i>To 12/96 With Hydraulic Tensioner</i>	
Timing Belt Kit with Water Pump	TFK075HP	<i>To 12/96 Kit with Hydraulic Tensioner &amp; kit contains TF3035 Pump</i>	
<b>Liberty Sohc</b>			
		10/98-8/07	4 Cyl 2.5L EJ25
Water Pump	TF3035	<i>To 5/03</i>	
Water Pump	TF8443	<i>From 6/03</i>	
Timing Belt Kit	TFK160H	<i>Kit contains Hydraulic Tensioner</i>	
Timing Belt Kit with Water Pump	TFK160HP	<i>Kit contains Hydraulic Tensioner &amp; kit contains TF3035 Pump</i>	
<b>Liberty Dohc</b>			
		11/96-2/00	4 Cyl 2.5L EJ25D
Water Pump	TF3067	<i>Single Outlet</i>	
Timing Belt Kit	TFK161H	<i>Kit contains Hydraulic Tensioner</i>	
<b>Liberty incl.Turbo &amp; GT Dohc</b>			
		5/03-on	4 Cyl 2.5L EJ255T
Water Pump	TF3091	<i>Triple Outlet</i>	
<b>Liberty</b>			
		8/04-9/09	6 Cyl 3.0L EZ30
Water Pump	TF8268		
<b>Outback Dohc</b>			
		9/96-10/98	4 Cyl 2.5L EJ25D
Water Pump	TF3067	<i>Single Outlet</i>	

Description	Part No	Year & Notes	Engine
<b>SUBARU</b>			
<b>Outback Sohc</b>		<b>10/98-on</b>	<b>4 Cyl 2.5L EJ25</b>
Water Pump	<b>TF3035</b>	<i>Single Outlet (confirm Thermostat Housing with image)</i>	
Water Pump	<b>TF3067</b>	<i>Single Outlet (confirm Thermostat Housing with image)</i>	
Timing Belt Kit	<b>TFK160H</b>	<i>Kit contains Hydraulic Tensioner</i>	
Timing Belt Kit with Water Pump	<b>TFK160HP</b>	<i>Kit contains Hydraulic Tensioner &amp; kit contains TF3035 Pump</i>	
Timing Belt Kit with Water Pump	<b>TFK160HP1</b>	<i>Kit contains Hydraulic Tensioner &amp; TF3067 Pump</i>	
<b>Outback</b>		<b>1/00-12/09</b>	<b>6 Cyl 3.0L EZ30</b>
Water Pump	<b>TF8268</b>		
<b>Sportswagon</b>		<b>8/94-12/96</b>	<b>4 Cyl 1.8L EA82</b>
Water Pump	<b>TF3033</b>		
<b>Sportswagon Sohc</b>		<b>1/96-12/00</b>	<b>4 Cyl 2.0L EJ20</b>
Water Pump	<b>TF3035</b>	<i>Single Outlet</i>	
<b>SVX</b>		<b>3/92-8/97</b>	<b>6 Cyl 3.3L EG33</b>
Water Pump	<b>TF3035</b>	<i>Single Outlet</i>	
<b>Tribeca</b>		<b>11/06-12/07</b>	<b>6 Cyl 3.0L EZ30</b>
Water Pump	<b>TF8268</b>		
<b>Vortex</b>		<b>9/85-9/89</b>	<b>4 Cyl 1.8L EA82</b>
Water Pump	<b>TF3033</b>		
<b>SUZUKI</b>			
<b>Alto</b>		<b>12/95-4/99</b>	<b>4 Cyl 993cc G10B</b>
Water Pump	<b>TF3037</b>		
<b>Alto</b>		<b>9/85-1/90</b>	<b>3 Cyl 543cc, 796cc F5A, F8B</b>
Water Pump	<b>TF2003</b>		
<b>Alto</b>		<b>8/09-on</b>	<b>3 Cyl 1.0L K10B, K10BN</b>
Water Pump	<b>TF8502</b>		
<b>APV GD</b>		<b>8/05-on</b>	<b>4 Cyl 1.6L G16A</b>
Water Pump	<b>TF8151</b>		
Timing Belt Kit	<b>TFK125</b>		
<b>Baleno SY416</b>		<b>4/95-3/02</b>	<b>4 Cyl 1.6L G16B</b>
Water Pump	<b>TF3036</b>	<i>To Vin No. 40000</i>	
Water Pump	<b>TF8151</b>	<i>From Vin No. 40001</i>	
Timing Belt Kit	<b>TFK125</b>		

Description	Part No	Year & Notes	Engine
<b>SUZUKI</b>			
<b>Baleno SY418</b>		3/96-1/02	4 Cyl 1.8L J18A
<i>Water Pump</i>	<b>TF8153</b>		
<b>Carry ST10- ST90, GA413</b>		6/78-8/05	4 Cyl 796cc, 1.3L F8A, G13BB
<i>Water Pump</i>	<b>TF2003</b>		
<b>Grand Vitara</b>		10/99-12/03	4 Cyl 1.6L G16B
<i>Water Pump</i>	<b>TF8151</b>		
<i>Fan Clutch</i>	<b>TFC145</b>		
<i>Radiator Fan Blade</i>	<b>TFB525</b>	<i>5 Blade Fan</i>	
<i>Timing Belt Kit</i>	<b>TFK125</b>		
<b>Grand Vitara</b>		2/03-12/08	4 Cyl 1.6L M16A
<i>Water Pump</i>	<b>TF8266</b>		
<i>Fan Clutch</i>	<b>TFC145</b>		
<b>Grand Vitara</b>		1/08-on	4 Cyl 1.9L F9QB
<i>Thermostat &amp; Housing</i>	<b>TTH565</b>		
<b>Grand Vitara</b>		4/98-7/08	4 Cyl 2.0L J20A
<i>Water Pump</i>	<b>TF8153</b>		
<i>Fan Clutch</i>	<b>TFC168</b>		
<b>Grand Vitara</b>		4/98-9/05	V6 2.5L H25A
<i>Water Pump</i>	<b>TF8154</b>		
<i>Fan Clutch</i>	<b>TFC168</b>		
<i>Radiator Fan Blade</i>	<b>TFB501</b>		
<b>Grand Vitara</b>		7/01-9/08	V6 2.7L H27A
<i>Water Pump</i>	<b>TF8154</b>		
<i>Fan Clutch</i>	<b>TFC187</b>		
<b>Grand Vitara</b>		9/08-on	V6 3.2L N32A
<i>Water Pump</i>	<b>TF8448</b>		
<b>Hatch SS40</b>		2/80-12/85	3 Cyl 543cc, 796cc F5A, F8B
<i>Water Pump</i>	<b>TF2003</b>		
<b>Ignis</b>		10/00-2/06	4 Cyl 1.3L, 1.5L M13A, M15A
<i>Water Pump</i>	<b>TF8266</b>		



Description	Part No	Year & Notes	Engine
<b>SUZUKI</b>			
<b>Jimny</b>			
		10/98-9/02	4 Cyl 1.3L G13BB
Water Pump	TF8270	To 10/00	
Water Pump	TF8266	From 11/00	
Fan Clutch	TFC129		
Radiator Fan Blade	TFB525	To 10/00	
<b>Jimny</b>			
		10/00-on	4 Cyl 1.3L M13A
Water Pump	TF8266		
Fan Clutch	TFC129		
Radiator Fan Blade	TFB550		
<b>Kizashi</b>			
		5/10-on	4 Cyl 2.4L J24B
Water Pump	TF8447		
<b>Liana RH416, RH418</b>			
		11/01-11/07	4 Cyl 1.6L, 1.8L M16A, M18A
Water Pump	TF8266		
<b>LJ80, LJ81</b>			
		11/77-12/81	4 Cyl 797cc F8A
Water Pump	TF2003		
<b>Mighty Boy SS40T</b>			
		7/85-10/88	3 Cyl 543cc F5A
Water Pump	TF2003		
<b>Sierra Stockman</b>			
		3/90-12/98	4 Cyl 1.0L F10A
Water Pump	TF2003		
<b>Sierra SJ50, SJ51</b>			
		10/83-12/91	4 Cyl 1.3L G13A
Water Pump	TF2008		
Radiator Fan Blade	TFB531	To 3/90	
Timing Belt Kit	TFK067		
<b>Sierra SJ70</b>			
		1/89-7/99	4 Cyl 1.3L G13BA
Water Pump	TF3012		
Radiator Fan Blade	TFB531		
Timing Belt Kit	TFK067		
<b>Sierra SJ80</b>			
		3/90-7/99	4 Cyl 1.3L G13BA
Water Pump	TF8270		
Fan Clutch	TFC145		
Radiator Fan Blade	TFB525	5 Blade Fan	
Timing Belt Kit	TFK067		

Description	Part No	Year & Notes	Engine
<b>SUZUKI</b>			
<b>Super Carry SK410</b>		<b>7/85-1/90</b>	<b>4 Cyl 970cc F10A</b>
Water Pump	<b>TF2003</b>		
<b>Swift SA310, SF310</b>		<b>3/84-5/96</b>	<b>3 Cyl 993cc G10A</b>
Water Pump	<b>TF2008</b>	<i>To 12/88 SA310 Model</i>	
Water Pump	<b>TF3037</b>	<i>From 1/89 SF310 Model</i>	
Timing Belt Kit	<b>TFK067</b>	<i>To 12/88</i>	
<b>Swift SA413, SF413</b>		<b>1/85-1/99</b>	<b>4 Cyl 1.3L G13A</b>
Water Pump	<b>TF3037</b>	<i>With Automatic Transmission. Pump has Timing Bolt hole</i>	
Water Pump	<b>TF3012</b>	<i>With Manual Transmission</i>	
Timing Belt Kit	<b>TFK067</b>	<i>To 12/88</i>	
<b>Swift Cino</b>		<b>5/94-6/00</b>	<b>4 Cyl 1.3L G13BA</b>
Water Pump	<b>TF3037</b>	<i>Without Housing</i>	
<b>Swift</b>		<b>2/05-on</b>	<b>4 Cyl 1.5L, 1.6L M15A, M16A</b>
Water Pump	<b>TF8266</b>		
<b>Swift SF416</b>		<b>10/89-4/96</b>	<b>4 Cyl 1.6L G16B</b>
Water Pump	<b>TF3036</b>		
Timing Belt Kit	<b>TFK125</b>		
<b>SX4 GY</b>		<b>2/07-on</b>	<b>4 Cyl 2.0L J20A, J20B</b>
Water Pump	<b>TF8153</b>	<i>To 1/10</i>	
Water Pump	<b>TF8485</b>	<i>From 2/10</i>	
<b>Vitara SE416</b>		<b>7/88-10/95</b>	<b>4 Cyl 1.6L G16A</b>
Water Pump	<b>TF3036</b>		
Fan Clutch	<b>TFC145</b>		
Radiator Fan Blade	<b>TFB525</b>	<i>5 Blade Fan</i>	
<b>Vitara SZ416</b>		<b>1/91-5/99</b>	<b>4 Cyl 1.6L G16B</b>
Water Pump	<b>TF3036</b>		
Fan Clutch	<b>TFC145</b>		
Radiator Fan Blade	<b>TFB526</b>	<i>5 Blade Fan</i>	
Timing Belt Kit	<b>TFK125</b>		
<b>Vitara SV420, SV620</b>		<b>3/95-5/99</b>	<b>4 Cyl 2.0L H20A, J20A</b>
Water Pump	<b>TF8153</b>		
Fan Clutch	<b>TFC168</b>		

Description	Part No	Year & Notes	Engine
<b>SUZUKI</b>			
<b>X90 SZ416</b>		<b>3/96-6/98</b>	<b>4 Cyl 1.6L G16B</b>
Water Pump	<b>TF3036</b>		
Fan Clutch	<b>TFC145</b>		
Radiator Fan Blade	<b>TFB525</b>	<i>5 Blade Fan</i>	
Timing Belt Kit	<b>TFK125</b>		
<b>XL7 JA627</b>		<b>5/05-1/06</b>	<b>V6 2.7L H27A</b>
Water Pump	<b>TF8154</b>		
Fan Clutch	<b>TFC168</b>		
<b>TOYOTA</b>			
<b>4 Runner LN60, LN61 Diesel</b>		<b>7/84-9/89</b>	<b>4 Cyl 2.4L 2L</b>
Water Pump	<b>TF1061</b>		
Fan Clutch	<b>TFC180</b>		
Radiator Fan Blade	<b>TFB508</b>	<i>7 Blade Fan</i>	
Timing Belt Kit	<b>TFK019</b>		
<b>4 Runner LN61 Diesel</b>		<b>5/89-9/89</b>	<b>4 Cyl 2.8L 3L</b>
Water Pump	<b>TF3046</b>		
Fan Clutch	<b>TFC192</b>		
Timing Belt Kit	<b>TFK020</b>		
Timing Belt Kit with Water Pump	<b>TFK020P</b>	<i>Kit contains TF3046 Pump</i>	
<b>4 Runner LN130 Diesel</b>		<b>10/89-6/96</b>	<b>4 Cyl 2.8L 3L</b>
Water Pump	<b>TF3046</b>		
Fan Clutch	<b>TFC192</b>		
Radiator Fan Blade	<b>TFB509</b>		
Timing Belt Kit	<b>TFK020</b>		
Timing Belt Kit with Water Pump	<b>TFK020P</b>	<i>Kit contains TF3046 Pump</i>	
<b>4 Runner RN130</b>		<b>10/89-6/96</b>	<b>4 Cyl 2.4L 22R</b>
Water Pump	<b>TF3045</b>		
Fan Clutch	<b>TFC130</b>		
Radiator Fan Blade	<b>TFB503</b>	<i>7 Blade Fan</i>	
<b>4 Runner YN60, YN63</b>		<b>7/84-10/90</b>	<b>4 Cyl 2.0L, 2.2L 3YC, 4Y, 4YEC</b>
Water Pump	<b>TF894</b>		
Fan Clutch	<b>TFC116</b>		
Radiator Fan Blade	<b>TFB503</b>	<i>7 Blade Fan</i>	

Description	Part No	Year & Notes	Engine
<b>TOYOTA</b>			
<b>4 Runner YN63</b>			
		5/89-9/89	4 Cyl 2.4L 22R
Water Pump	TF3045		
Fan Clutch	TFC130		
<b>4 Runner YN130</b>			
		10/89-12/90	4 Cyl 2.2L 4YE
Water Pump	TF894		
Fan Clutch	TFC116		
Radiator Fan Blade	TFB503	7 Blade Fan	
<b>4 Runner VZN130</b>			
		10/90-7/96	V6 3.0L 3VZE
Water Pump	TF3049	To 8/92 (Check Identification Guide)	
Water Pump	TF3105	From 8/92 (Check Identification Guide)	
Fan Clutch	TFC175	To 8/94	
Fan Clutch	TFC169	From 9/94	
Radiator Fan Blade	TFB517	To 8/93	
Radiator Fan Blade	TFB518	From 8/93	
<b>Avalon MCX10</b>			
		7/00-3/06	V6 3.0L 1MZFE
Water Pump	TF9092		
Heater Valve / Tap	TFT7010		
Timing Belt Kit	TFK100		
Timing Belt Kit	TFK100H	Kit contains Hydraulic Tensioner	
Timing Belt Kit with Water Pump	TFK100HP	Kit contains TF9092 Pump	
<b>Avante ST141</b>			
		11/84-4/87	4 Cyl 2.0L 2SC
Water Pump	TF1053		
<b>Avante RT142</b>			
		11/84-4/87	4 Cyl 2.4L 22RE
Water Pump	TF3045		
<b>Aurion GSV40</b>			
		10/06-on	V6 3.5L 2GRFE
Water Pump	TF8253		
<b>Avensis Verso ACM20, ACM21</b>			
		12/01-on	4 Cyl 2.0L, 2.4L 1AZFE, 2AZFE
Water Pump	TF8227		
<b>Blizzard LD10 Diesel</b>			
		3/82-12/83	4 Cyl 2.2L L
Water Pump	TF819		
<b>Bundera LJ70 Diesel</b>			
		1/86-12/91	4 Cyl 2.4L 2LT
Water Pump	TF3046		
Fan Clutch	TFC179		
Radiator Fan Blade	TFB508	7 Blade Fan	
Timing Belt Kit	TFK019	To 3/90	

Description	Part No	Year & Notes	Engine
<b>TOYOTA</b>			
<b>Bundera RJ70</b>			
		1/85-12/91	4 Cyl 2.4L 22R
Water Pump	TF3045		
Fan Clutch	TFC130		
Radiator Fan Blade	TFB503	7 Blade Fan	
<b>Camry ACV36, ACV40</b>			
		9/02-on	4 Cyl 2.4L 2AZFE
Water Pump	TF8227		
Timing Chain Kit	TCK112	Without VVT	
<b>Camry AVH40</b>			
		1/10-on	V6 2.4L 2AZFE
Water Pump	TF8227		
Inverter Water Pump	TF8451	Inverter Pump	
<b>Camry ASV50, AVV50</b>			
		12/11-on	4 Cyl 2.5L 2ARFE, 2ARFXE
Water Pump	TF8487		
<b>Camry MCV20, MCV36</b>			
		8/97-6/06	V6 3.0L 1MZFE
Water Pump	TF9092		
Heater Valve / Tap	TFT7010	To 8/02	
Timing Belt Kit	TFK100		
Timing Belt Kit	TFK100H	Kit contains Hydraulic Tensioner	
Timing Belt Kit with Water Pump	TFK100HP	Kit contains TF9020 Pump	
<b>Camry SDV10</b>			
		2/93-4/95	4 Cyl 2.2L 5SFE
Water Pump	TF3047	Pump without Housing	
Water Pump	TF3047H	Pump with Housing	
Heater Valve / Tap	TFT7010		
<b>Camry SV11, SV21</b>			
		4/83-8/89	4 Cyl 1.8L, 2.0L 1SE, 2SE
Water Pump	TF1053		
<b>Camry SV21, SV22</b>			
		5/87-2/93	4 Cyl 2.0L 3SFE, 3SFC
Water Pump	TF3047	Pump without Housing	
Water Pump	TF3047H	Pump with Housing	
Timing Belt Kit	TFK013		
Timing Belt Kit with Water Pump	TFK013P	Kit contains TF3047 Pump without Housing	
Timing Belt Kit with Water Pump	TFK013PC	Kit contains TF3047H Pump with Housing	



Description	Part No	Year & Notes	Engine
<b>TOYOTA</b>			
<b>Camry SXV10, SXV20</b>			
		<b>4/95-8/02</b>	<b>4 Cyl 2.2L 5SFE</b>
Water Pump	<b>TF3047</b>	<i>Pump without Housing</i>	
Water Pump	<b>TF3047H</b>	<i>Pump with Housing</i>	
Heater Valve / Tap	<b>TFT7010</b>		
Timing Belt Kit	<b>TFK013</b>		
Timing Belt Kit with Water Pump	<b>TFK013P</b>	<i>Kit contains TF3047 Pump without Housing</i>	
Timing Belt Kit with Water Pump	<b>TFK013PC</b>	<i>Kit contains TF3047H Pump with Housing</i>	
<b>Camry VZV21R</b>			
		<b>6/88-2/03</b>	<b>V6 2.5L 2VZFE</b>
Water Pump	<b>TF3040</b>		
<b>Camry VCV10R, VDV10</b>			
		<b>2/93-8/97</b>	<b>V6 3.0L 3VZFE</b>
Water Pump	<b>TF3040</b>		
Heater Valve / Tap	<b>TFT7010</b>		
Timing Belt Kit	<b>TFK011</b>		
<b>Celica TA22, TA23</b>			
		<b>11/71-12/76</b>	<b>4 Cyl 1.6L 2T</b>
Water Pump	<b>TF798</b>		
<b>Celica RA23, RA28, RA40</b>			
		<b>6/76-10/81</b>	<b>4 Cyl 2.0L 18R, 18RC</b>
Water Pump	<b>TF836A</b>	<i>Pump only</i>	
<b>Celica RA60</b>			
		<b>11/81-9/83</b>	<b>4 Cyl 2.0L 21RC</b>
Water Pump	<b>TF842</b>		
Fan Clutch	<b>TFC130</b>		
Radiator Fan Blade	<b>TFB503</b>	<i>7 Blade Fan</i>	
<b>Celica RA65</b>			
		<b>10/84-12/85</b>	<b>4 Cyl 2.4L 22REC</b>
Water Pump	<b>TF3045</b>		
Fan Clutch	<b>TFC130</b>		
Radiator Fan Blade	<b>TFB503</b>	<i>7 Blade Fan</i>	
<b>Celica SA63</b>			
		<b>10/83-9/84</b>	<b>4 Cyl 2.0L 2SC</b>
Water Pump	<b>TF1053</b>		
<b>Celica ST162</b>			
		<b>11/86-11/89</b>	<b>4 Cyl 2.0L 3SFE</b>
Water Pump	<b>TF3047</b>	<i>Pump without Housing</i>	
Water Pump	<b>TF3047H</b>	<i>Pump with Housing</i>	
Heater Valve / Tap	<b>TFT7002</b>		
Timing Belt Kit	<b>TFK013</b>		
Timing Belt Kit with Water Pump	<b>TFK013P</b>	<i>Kit contains TF3047 Pump without Housing</i>	
Timing Belt Kit with Water Pump	<b>TFK013PC</b>	<i>Kit contains TF3047H Pump with Housing</i>	

Description	Part No	Year & Notes	Engine
<b>TOYOTA</b>			
<b>Celica ST162</b>			
		<b>11/85-10/89</b>	<b>4 Cyl 2.0L 3SGE</b>
Water Pump	<b>TF1090</b>		
Heater Valve / Tap	<b>TFT7002</b>		
<b>Celica ST184</b>			
		<b>11/89-3/94</b>	<b>4 Cyl 2.2L 5SFE</b>
Water Pump	<b>TF3047</b>	<i>Pump without Housing</i>	
Water Pump	<b>TF3047H</b>	<i>Pump with Housing</i>	
Heater Valve / Tap	<b>TFT7003</b>		
Timing Belt Kit	<b>TFK013</b>	<i>Kit contains TF3047 Pump without Housing</i>	
Timing Belt Kit with Water Pump	<b>TFK013P</b>	<i>Kit contains TF3047H Pump with Housing</i>	
<b>Celica ST185 Turbo</b>			
		<b>3/90-12/92</b>	<b>4 Cyl 2.0L 3SGTE</b>
Water Pump	<b>TF3041</b>	<i>Pump without Housing</i>	
Water Pump	<b>TF3041H</b>	<i>Pump with Housing</i>	
Heater Valve / Tap	<b>TFT7003</b>		
<b>Celica ST204</b>			
		<b>3/94-11/99</b>	<b>4 Cyl 2.2L 5SFE</b>
Water Pump	<b>TF3047</b>	<i>Pump without Housing</i>	
Water Pump	<b>TF3047H</b>	<i>Pump with Housing</i>	
Heater Valve / Tap	<b>TFT7004</b>		
Timing Belt Kit	<b>TFK013</b>	<i>Kit contains TF3047 Pump without Housing</i>	
Timing Belt Kit with Water Pump	<b>TFK013P</b>	<i>Kit contains TF3047H Pump with Housing</i>	
<b>Celica ST205 Turbo</b>			
		<b>5/94-12/94</b>	<b>4 Cyl 2.0L 3SGTE</b>
Water Pump	<b>TF3041</b>	<i>Pump without Housing</i>	
Water Pump	<b>TF3041H</b>	<i>Pump with Housing</i>	
Heater Valve / Tap	<b>TFT7004</b>		
<b>Celica ZTZ231</b>			
		<b>11/99-1/06</b>	<b>4 Cyl 1.8L 2ZZGE</b>
Water Pump	<b>TF8228</b>		
<b>Coaster BB20, BB21 Diesel</b>			
		<b>1/84-6/92</b>	<b>4 Cyl 3.4L 3B</b>
Water Pump	<b>TF3068</b>	<i>To 8/88</i>	
Water Pump	<b>TF8142</b>	<i>From 9/88</i>	
Fan Clutch	<b>TFC143</b>	<i>All</i>	
<b>Coaster BB40 Diesel</b>			
		<b>2/93-11/99</b>	<b>4 Cyl 3.4L 13B</b>
Water Pump	<b>TF8142</b>		
Fan Clutch	<b>TFC230</b>		
<b>Coaster BB50 Diesel</b>			
		<b>2/03-9/06</b>	<b>4 Cyl 4.1L 15BFTE</b>
Water Pump	<b>TF8284</b>		
Radiator Fan Blade	<b>TFB532</b>		

Description	Part No	Year & Notes	Engine
<b>TOYOTA</b>			
<b>Coaster HB30 Diesel</b>			
		<b>1/87-1/90</b>	<b>6 Cyl 4.0L 2H</b>
Water Pump	<b>TF896</b>		
Fan Clutch	<b>TFC107</b>	<i>Pulley holes Centre to Centre 60mm</i>	
Radiator Fan Blade	<b>TFB504</b>		
<b>Coaster HZB30 Diesel</b>			
		<b>1/90-1/93</b>	<b>6 Cyl 4.2L 1HZ</b>
Water Pump	<b>TF3106</b>		
Fan Clutch	<b>TFC106</b>	<i>Pulley holes Centre to Centre 62mm</i>	
Radiator Fan Blade	<b>TFB500</b>		
Timing Belt Kit	<b>TFK083</b>	<i>To 5/92</i>	
Timing Belt Kit	<b>TFK170</b>	<i>From 6/92</i>	
Timing Belt Kit with Water Pump	<b>TFK083P</b>	<i>To 5/92</i>	
Timing Belt Kit	<b>TFK170H</b>	<i>From 6/92 Kit contains Hydraulic Tensioner</i>	
<b>Coaster HZB50 Diesel</b>			
		<b>2/93-2/03</b>	<b>6 Cyl 4.2L 1HZ</b>
Water Pump	<b>TF3106</b>		
Fan Clutch	<b>TFC106</b>	<i>To 7/99</i>	
Fan Clutch	<b>TFC218</b>	<i>From 8/99</i>	
Radiator Fan Blade	<b>TFB500</b>	<i>To 7/97</i>	
Radiator Fan Blade	<b>TFB522</b>	<i>From 7/97</i>	
Timing Belt Kit	<b>TFK170</b>	<i>From 6/92</i>	
Timing Belt Kit	<b>TFK170H</b>	<i>From 6/92 Kit contains Hydraulic Tensioner</i>	
<b>Coaster RB11, RB13, RB20</b>			
		<b>1/79-8/84</b>	<b>4 Cyl 2.2L 20R, 22R</b>
Water Pump	<b>TF842</b>		
Fan Clutch	<b>TFC130</b>		
Radiator Fan Blade	<b>TFB503</b>	<i>7 Blade Fan</i>	
<b>Coaster XZB50R</b>			
		<b>9/06-on</b>	<b>4 Cyl 4.0L NC04CTU</b>
Fan Clutch	<b>TFC227</b>		
Radiator Fan Blade	<b>TFB512</b>		
<b>Corolla AE71</b>			
		<b>10/83-4/85</b>	<b>4 Cyl 1.6L 4AC</b>
Water Pump	<b>TF5003</b>		
Timing Belt Kit	<b>TFK021</b>		
<b>Corolla AE80</b>			
		<b>4/85-5/89</b>	<b>4 Cyl 1.3L 2AC</b>
Water Pump	<b>TF1058</b>	<i>Pump without Housing</i>	
Water Pump	<b>TF1058H</b>	<i>Pump with Housing</i>	
Timing Belt Kit	<b>TFK021</b>		

Description	Part No	Year & Notes	Engine
<b>TOYOTA</b>			
<b>Corolla AE82 Sohc</b>			
		<b>4/85-5/89</b>	<b>4 Cyl 1.6L 4ALC</b>
Water Pump	<b>TF1058</b>	<i>Pump without Housing</i>	
Water Pump	<b>TF1058H</b>	<i>Pump with Housing</i>	
Timing Belt Kit	<b>TFK021</b>		
<b>Corolla AE82 Dohc</b>			
		<b>9/86-5/89</b>	<b>4 Cyl 1.6L 4AGE</b>
Water Pump	<b>TF1063</b>		
<b>Corolla AE86</b>			
		<b>7/83-12/85</b>	<b>4 Cyl 1.6L 4AC</b>
Water Pump	<b>TF5003</b>		
Timing Belt Kit	<b>TFK021</b>		
<b>Corolla AE90</b>			
		<b>7/89-11/92</b>	<b>4 Cyl 1.4L 6AFC</b>
Water Pump	<b>TF3039</b>	<i>Pump without Housing</i>	
Water Pump	<b>TF3039H</b>	<i>Pump with Housing</i>	
<b>Corolla AE92</b>			
		<b>6/89-9/94</b>	<b>4 Cyl 1.6L 4AFC, 4AFE</b>
Water Pump	<b>TF3039</b>	<i>Pump without Housing</i>	
Water Pump	<b>TF3039H</b>	<i>Pump with Housing</i>	
Timing Belt Kit	<b>TFK012</b>	<i>Square 94 Teeth Timing Belt</i>	
Timing Belt Kit with Water Pump	<b>TFK012P</b>	<i>TF3039 Pump without Housing</i>	
Timing Belt Kit with Water Pump	<b>TFK012PC</b>	<i>TF3039H Pump with Housing</i>	
Timing Belt Kit	<b>TFK015</b>	<i>Round 117 Teeth Timing Belt</i>	
Timing Belt Kit with Water Pump	<b>TFK015P</b>	<i>Contains TF3039 Pump without Housing</i>	
Timing Belt Kit with Water Pump	<b>TFK015PC</b>	<i>Contains TF3039H Pump with Housing</i>	
<b>Corolla AE92</b>			
		<b>7/89-9/94</b>	<b>4 Cyl 1.6L 4AGE</b>
Water Pump	<b>TF1063</b>		
<b>Corolla AE93</b>			
		<b>11/92-9/94</b>	<b>4 Cyl 1.8L 7AFE</b>
Water Pump	<b>TF3083</b>	<i>Pump without Housing</i>	
Water Pump	<b>TF4015</b>	<i>Pump with Housing</i>	
Timing Belt Kit	<b>TFK016</b>		
Timing Belt Kit with Water Pump	<b>TFK016P</b>	<i>Kit contains TF3083 Pump without Housing</i>	
Timing Belt Kit with Water Pump	<b>TFK016PC</b>	<i>Kit contains TF4115 Pump with Housing</i>	

Description	Part No	Year & Notes	Engine
<b>TOYOTA</b>			
<b>Corolla AE95</b>			
		<b>4/88-7/95</b>	<b>4 Cyl 1.6L 4AFE</b>
Water Pump	<b>TF3039</b>	<i>Pump without Housing</i>	
Water Pump	<b>TF3039H</b>	<i>Pump with Housing</i>	
Heater Valve / Tap	<b>TFT7000</b>		
<b>Corolla AE101</b>			
		<b>9/94-7/00</b>	<b>4 Cyl 1.6L 4AFE</b>
Water Pump	<b>TF3084</b>	<i>Pump without Housing</i>	
Water Pump	<b>TF3084H</b>	<i>Pump with Housing</i>	
Heater Valve / Tap	<b>TFT7009</b>		
Timing Belt Kit	<b>TFK015</b>	<i>Kit with Round 117 Teeth Timing Belt</i>	
<b>Corolla AE102</b>			
		<b>9/94-12/99</b>	<b>4 Cyl 1.8L 7AFE</b>
Water Pump	<b>TF3083</b>	<i>Pump without Housing</i>	
Water Pump	<b>TF4015</b>	<i>Pump with Housing</i>	
Heater Valve / Tap	<b>TFT7009</b>		
Timing Belt Kit	<b>TFK016</b>		
Timing Belt Kit with Water Pump	<b>TFK016P</b>	<i>Kit contains TF3083 Pump without Housing</i>	
Timing Belt Kit with Water Pump	<b>TFK016PC</b>	<i>Kit contains TF4115 Pump with Housing</i>	
<b>Corolla AE112</b>			
		<b>9/98-12/01</b>	<b>4 Cyl 1.8L 7AFE</b>
Water Pump	<b>TF3083</b>	<i>Pump without Housing</i>	
Water Pump	<b>TF4015</b>	<i>Pump with Housing</i>	
Heater Valve / Tap	<b>TFT7001</b>		
Timing Belt Kit	<b>TFK016</b>		
Timing Belt Kit with Water Pump	<b>TFK016P</b>	<i>Kit contains TF3083 Pump without Housing</i>	
Timing Belt Kit with Water Pump	<b>TFK016PC</b>	<i>Kit contains TF4115 Pump with Housing</i>	
<b>Corolla KE30, KE35, KE36, KE50</b>			
		<b>2/71-11/78</b>	<b>4 Cyl 1.2L 3KC</b>
Water Pump	<b>TF835</b>		
<b>Corolla KE38, KE55, KE70</b>			
		<b>11/78-4/85</b>	<b>4 Cyl 1.3L 4KC</b>
Water Pump	<b>TF859</b>	<i>To 4/83</i>	
Water Pump	<b>TF897</b>	<i>From 5/83</i>	



Description	Part No	Year & Notes	Engine
<b>TOYOTA</b>			
<b>Corolla ZZE122</b>		12/01-5/07	4 Cyl 1.8L 1ZZFE
Water Pump	TF7011		
Heater Valve / Tap	TFT7001		
Timing Chain Kit	TCK115G	<i>Models with VVT (kit with Gears)</i>	
<b>Corolla ZZE123</b>		5/03-4/06	4 Cyl 1.8L 2ZZGE
Water Pump	TF8228		
<b>Corolla ZE152</b>		5/07-on	4 Cyl 1.8L 2ZRFE
Water Pump	TF8295		
<b>Corona MX13, MX23</b>		11/74-12/77	6 Cyl 2.6L 4M
Water Pump	TF841		
<b>Corona RT40</b>		11/64-6/69	4 Cyl 1.6L 4R
Water Pump	TF731		
<b>Corona RT81</b>		8/71-2/74	4 Cyl 1.6L 12R
Water Pump	TF959		
<b>Corona RT104, RT118 , RT132</b>		3/74-12/81	4 Cyl 2.0L 18RC
Water Pump	TF836A	<i>Pump only</i>	
<b>Corona RT133</b>		1/82-8/82	4 Cyl 2.0L 21RC
Water Pump	TF842		
Fan Clutch	TFC130		
<b>Corona RT142</b>		11/84-4/87	4 Cyl 2.4L 22RE
Water Pump	TF3045		
Fan Clutch	TFC130		
Radiator Fan Blade	TFB503	<i>7 Blade Fan</i>	
<b>Corona ST141</b>		8/83-4/87	4 Cyl 2.0L 2SC
Water Pump	TF1053		
<b>Corona XT130</b>		10/79-7/83	4 Cyl 1.9L Starfire
Water Pump	TF814		
Fan Clutch	TFC102		
Radiator Fan Blade	TFB503	<i>7 Blade Fan</i>	
<b>Cressida MX32, MX36</b>		3/77-12/80	6 Cyl 2.6L 4M
Water Pump	TF841		
Fan Clutch	TFC112		

Description	Part No	Year & Notes	Engine
<b>TOYOTA</b>			
<b>Cressida MX62</b>		2/81-11/84	6 Cyl 2.8L 5ME
Water Pump	TF1055		
Fan Clutch	TFC112		
Radiator Fan Blade	TFB504		
<b>Cressida MX73 Sohc</b>		11/84-5/88	6 Cyl 2.8L 5ME, 5MGE
Water Pump	TF1055	To 10/85	
<b>Cressida MX73 Dohc</b>		11/84-5/88	6 Cyl 2.8L 5ME, 5MGE
Water Pump	TF816	From 11/85	
<b>Cressida MX73</b>		11/84-5/88	6 Cyl 2.8L 5ME, 5MGE
Fan Clutch	TFC112		
Radiator Fan Blade	TFB504		
<b>Cressida MX83</b>		10/88-8/93	6 Cyl 3.0L 7MGE
Water Pump	TF3042		
Fan Clutch	TFC112		
Radiator Fan Blade	TFB504		
<b>Crown MS65, MS83, MS85</b>		1971-12/80	6 Cyl 2.6L 4M
Water Pump	TF841		
Fan Clutch	TFC112		
<b>Crown MS111</b>		9/79-10/80	6 Cyl 2.6L 4M
Water Pump	TF841		
Radiator Fan Blade	TFB504		
<b>Crown MS112</b>		10/80-10/83	6 Cyl 2.8L 5ME
Water Pump	TF1055		
Fan Clutch	TFC112		
Radiator Fan Blade	TFB504		
<b>Crown MS123</b>		10/83-5/88	6 Cyl 2.8L 5ME, 5MGE
Water Pump	TF816		
Fan Clutch	TFC112		
Radiator Fan Blade	TFB504		
<b>Dyna BU20 Diesel</b>		1976-12/84	4 Cyl 3.0L B
Water Pump	TF885		
<b>Dyna BU20 Diesel</b>		1976-85	4 Cyl 3.4L 3B
Water Pump	TF9075		

Description	Part No	Year & Notes	Engine
<b>TOYOTA</b>			
<b>Dyna BU60, BU63 Diesel</b>		<b>11/84-6/95</b>	<b>4 Cyl 3.0L B</b>
Water Pump	<b>TF9075</b>	<i>To 8/88</i>	
Water Pump	<b>TF8206</b>	<i>From 9/88 to 4/92</i>	
Water Pump	<b>TF3078</b>	<i>From 5/92</i>	
Fan Clutch	<b>TFC143</b>	<i>To 8/88</i>	
Fan Clutch	<b>TFC170</b>	<i>From 9/88</i>	
Radiator Fan Blade	<b>TFB531</b>	<i>All</i>	
<b>Dyna BU61 Diesel</b>		<b>11/85-6/95</b>	<b>4 Cyl 3.0L 11B</b>
Water Pump	<b>TF3038</b>	<i>To 8/88</i>	
Water Pump	<b>TF3078</b>	<i>From 9/88</i>	
Fan Clutch	<b>TFC143</b>	<i>To 8/88</i>	
Fan Clutch	<b>TFC170</b>	<i>From 9/88</i>	
Radiator Fan Blade	<b>TFB531</b>	<i>All</i>	
<b>Dyna BU65, BU66 Diesel</b>		<b>1/89-6/95</b>	<b>4 Cyl 3.0L 11B</b>
Water Pump	<b>TF3078</b>		
Fan Clutch	<b>TFC170</b>		
Radiator Fan Blade	<b>TFB531</b>		
<b>Dyna BU85 Diesel</b>		<b>11/84-8/88</b>	<b>4 Cyl 3.4L 13B</b>
Water Pump	<b>TF3038</b>		
Fan Clutch	<b>TFC143</b>		
Radiator Fan Blade	<b>TFB503</b>		
<b>Dyna BU88</b>		<b>1/88-1/93</b>	<b>4 Cyl 3.7L 14B</b>
Water Pump	<b>TF3078</b>		
Fan Clutch	<b>TFC170</b>		
Radiator Fan Blade	<b>TFB503</b>	<i>7 Blade Fan</i>	
<b>Dyna BU88</b>		<b>1/88-8/95</b>	<b>4 Cyl 4.0L 1W</b>
Radiator Fan Blade	<b>TFB503</b>	<i>7 Blade Fan</i>	
<b>Dyna BU91 Diesel</b>		<b>1/88-8/95</b>	<b>4 Cyl 3.7L 14B</b>
Water Pump	<b>TF3078</b>		
Fan Clutch	<b>TFC170</b>		
Radiator Fan Blade	<b>TFB503</b>	<i>7 Blade Fan</i>	
<b>Dyna BU91 Diesel</b>		<b>1/88-8/95</b>	<b>4 Cyl 4.0L 1W</b>
Radiator Fan Blade	<b>TFB503</b>	<i>7 Blade Fan</i>	

Description	Part No	Year & Notes	Engine
<b>TOYOTA</b>			
<b>Dyna BU100, BU110 Diesel</b>		<b>6/95-5/03</b>	<b>4 Cyl 3.5L 3B</b>
Water Pump	<b>TF3078</b>		
Fan Clutch	<b>TFC170</b>		
<b>Dyna BU142, BU212, BU222 Diesel</b>		<b>7/95-5/03</b>	<b>4 Cyl 4.1L 15B</b>
Water Pump	<b>TF3078</b>		
Fan Clutch	<b>TFC170</b>		
<b>Dyna BU300, BU340 Turbo Diesel</b>		<b>5/03-1/04</b>	<b>4 Cyl 4.1L 15BFTE</b>
Water Pump	<b>TF8284</b>		
Radiator Fan Blade	<b>TFB532</b>		
<b>Dyna HU40 Turbo Diesel</b>		<b>1976-84</b>	<b>6 Cyl 4.0L 2H</b>
Water Pump	<b>TF896</b>		
Fan Clutch	<b>TFC107</b>		
<b>Dyna LH80 Diesel</b>		<b>12/85-4/91</b>	<b>4 Cyl 2.4L 2L</b>
Water Pump	<b>TF1061</b>		
Fan Clutch	<b>TFC180</b>	<i>To 8/88</i>	
Fan Clutch	<b>TFC192</b>	<i>From 9/88</i>	
Radiator Fan Blade	<b>TFB508</b>	<i>To 8/88</i>	
Radiator Fan Blade	<b>TFB509</b>	<i>From 8/88</i>	
Timing Belt Kit	<b>TFK019</b>		
<b>Dyna LY60 Diesel</b>		<b>11/85-9/88</b>	<b>4 Cyl 2.4L 2L</b>
Water Pump	<b>TF1061</b>		
Fan Clutch	<b>TFC180</b>		
Radiator Fan Blade	<b>TFB508</b>	<i>7 Blade Fan</i>	
Timing Belt Kit	<b>TFK019</b>		
<b>Dyna LY61 Diesel</b>		<b>10/88-6/95</b>	<b>4 Cyl 2.8L 3L</b>
Water Pump	<b>TF3046</b>		
Fan Clutch	<b>TFC192</b>		
Radiator Fan Blade	<b>TFB509</b>		
Timing Belt Kit	<b>TFK020</b>		
Timing Belt Kit with Water Pump	<b>TFK020P</b>	<i>Kit contains TF3046 Pump</i>	
<b>Dyna LY211 Diesel</b>		<b>12/94-8/01</b>	<b>4 Cyl 2.8L 3L</b>
Water Pump	<b>TF3046</b>		
Fan Clutch	<b>TFC192</b>		
Radiator Fan Blade	<b>TFB510</b>		
Timing Belt Kit	<b>TFK020</b>		
Timing Belt Kit with Water Pump	<b>TFK020P</b>	<i>Kit contains TF3046 Pump</i>	

Description	Part No	Year & Notes	Engine
<b>TOYOTA</b>			
<b>Dyna LY220 Diesel</b>		<b>1/89-6/05</b>	<b>4 Cyl 3.0L 5L</b>
Water Pump	<b>TF3046</b>		
Fan Clutch	<b>TFC192</b>		
Radiator Fan Blade	<b>TFB520</b>		
Timing Belt Kit with Water Pump	<b>TFK020P</b>	<i>Kit contains TF3046 Pump</i>	
<b>Dyna LY230 Diesel</b>		<b>9/01-4/05</b>	<b>4 Cyl 3.0L 5L</b>
Water Pump	<b>TF3046</b>		
Fan Clutch	<b>TFC179</b>		
Radiator Fan Blade	<b>TFB520</b>		
Timing Belt Kit with Water Pump	<b>TFK020P</b>	<i>Kit contains TF3046 Pump</i>	
<b>Dyna RU10 – RU30</b>		<b>1969-84</b>	<b>4 Cyl 2.0L 5R</b>
Water Pump	<b>TF858</b>		
<b>Dyna YH81</b>		<b>11/85-12/94</b>	<b>4 Cyl 1.8L 2YC</b>
Water Pump	<b>TF894</b>		
Fan Clutch	<b>TFC116</b>		
Radiator Fan Blade	<b>TFB503</b>	<i>7 Blade Fan</i>	
<b>Dyna YU60, YU62</b>		<b>11/84-12/91</b>	<b>4 Cyl 2.0L, 2.2L 3YC, 4YC</b>
Water Pump	<b>TF894</b>		
Fan Clutch	<b>TFC116</b>		
Radiator Fan Blade	<b>TFB505</b>		
<b>Echo NCP10, NCP12, NCP13</b>		<b>10/99-10/05</b>	<b>4 Cyl 1.3L, 1.5L 1NZFE, 2NZFE</b>
Water Pump	<b>TF4010</b>		
<b>Hi-Ace KDH200, 220, 222 Turbo Diesel</b>		<b>3/05-on</b>	<b>4 Cyl 2.5L 2KDFTV</b>
Water Pump	<b>TF8209</b>		
Timing Belt Kit	<b>TFK221</b>		
Timing Belt Kit	<b>TFK221H</b>	<i>Kit contains Hydraulic Tensioner</i>	
Timing Belt Kit with Water Pump	<b>TFK221P1</b>	<i>Kit contains TF8209 Pump</i>	
<b>Hi-Ace KDH201, 221, 223 Turbo Diesel</b>		<b>11/06-on</b>	<b>4 Cyl 3.0L 1KDFTV</b>
Water Pump	<b>TF8209</b>		
Timing Belt Kit	<b>TFK221</b>		
Timing Belt Kit	<b>TFK221H</b>	<i>Kit contains Hydraulic Tensioner</i>	
Timing Belt Kit with Water Pump	<b>TFK221P1</b>	<i>Kit contains TF8209 Pump</i>	
<b>Hi-Ace LH11 Diesel</b>		<b>1/83-12/85</b>	<b>4 Cyl 2.2L L</b>
Water Pump	<b>TF1061</b>		
Fan Clutch	<b>TFC180</b>		



Description	Part No	Year & Notes	Engine
<b>TOYOTA</b>			
<b>Hi-Ace LH20, LH30 Diesel</b>		<b>3/81-1/83</b>	<b>4 Cyl 2.2L L</b>
Water Pump	<b>TF819</b>	<i>To 10/82</i>	
Water Pump	<b>TF1061</b>	<i>From 11/82</i>	
Fan Clutch	<b>TFC180</b>	<i>All</i>	
<b>Hi-Ace LH51 – LH71 Diesel</b>		<b>2/83-9/89</b>	<b>4 Cyl 2.2L, 2.4L L, 2L</b>
Water Pump	<b>TF1061</b>		
Fan Clutch	<b>TFC180</b>		
Radiator Fan Blade	<b>TFB520</b>	<i>To 8/85</i>	
Radiator Fan Blade	<b>TFB508</b>	<i>From 8/85</i>	
Timing Belt Kit	<b>TFK019</b>		
<b>Hi-Ace LH103, LH113, LH125 Diesel</b>		<b>2/89-10/00</b>	<b>4 Cyl 2.8L 3L</b>
Water Pump	<b>TF3046</b>		
Fan Clutch	<b>TFC133</b>		
Radiator Fan Blade	<b>TFB508</b>	<i>7 Blade Fan</i>	
Timing Belt Kit	<b>TFK020</b>		
Timing Belt Kit with Water Pump	<b>TFK020P</b>	<i>Kit contains TF3046 Pump</i>	
<b>Hi-Ace LH162, LH172, LH184 Diesel</b>		<b>10/00-2/05</b>	<b>4 Cyl 3.0L 5L</b>
Water Pump	<b>TF3046</b>		
Fan Clutch	<b>TFC179</b>		
Radiator Fan Blade	<b>TFB520</b>		
Timing Belt Kit	<b>TFK020</b>		
Timing Belt Kit with Water Pump	<b>TFK020P</b>	<i>Kit contains TF3046 Pump</i>	
<b>Hi-Ace RCH12, RCH22</b>		<b>10/95-4/04</b>	<b>4 Cyl 2.4L 2RZ</b>
Water Pump	<b>TF8147</b>		
Fan Clutch	<b>TFC142</b>		
Radiator Fan Blade	<b>TFB503</b>	<i>7 Blade Fan</i>	
<b>Hi-Ace RH11, RH16</b>		<b>1/72-4/77</b>	<b>4 Cyl 1.6L 12R</b>
Water Pump	<b>TF959</b>		
<b>Hi-Ace RH32, RH42</b>		<b>5/77-1/83</b>	<b>4 Cyl 2.0L 18RC</b>
Water Pump	<b>TF836A</b>	<i>Pump only</i>	
Radiator Fan Blade	<b>TFB503</b>	<i>7 Blade Fan</i>	
<b>Hi-Ace RZH103, 113, 125</b>		<b>10/89-3/05</b>	<b>4 Cyl 2.4L 2RZ, 2RZE</b>
Water Pump	<b>TF3131</b>	<i>To 8/95 Carby Model</i>	
Water Pump	<b>TF8147</b>	<i>From 8/95 Carby &amp; Efi Model</i>	
Fan Clutch	<b>TFC142</b>		
Radiator Fan Blade	<b>TFB503</b>	<i>7 Blade Fan</i>	

Description	Part No	Year & Notes	Engine
<b>TOYOTA</b>			
<b>Hi-Ace TRH200, 201, 221, 223</b>			
		<b>3/05-on</b>	<b>4 Cyl 2.7L 2TRFE</b>
Water Pump	<b>TF4005</b>		
Fan Clutch	<b>TFC186</b>		
<b>Hi-Ace YH50 – YH73</b>			
		<b>1/83-10/89</b>	<b>4 Cyl 1.8L, 2.0L, 2.2L 2Y, 3Y, 4Y</b>
Water Pump	<b>TF894</b>		
Fan Clutch	<b>TFC116</b>		
Radiator Fan Blade	<b>TFB503</b>		
<b>Hi-Lux GGN15, GGN25</b>			
		<b>3/05-on</b>	<b>V6 4.0L 1GRFE</b>
Water Pump	<b>TF8272</b>		
Fan Clutch	<b>TFC156</b>		
Radiator Fan Blade	<b>TFB539</b>		
<b>Hi-Lux KUN16, KUN26 Turbo Diesel</b>			
		<b>3/05-on</b>	<b>4 Cyl 3.0L 1KDFTV</b>
Water Pump	<b>TF8144</b>	<i>To 8/06 Without Housing Base</i>	
Water Pump	<b>TF8144H</b>	<i>To 8/06 With Housing Base</i>	
Water Pump	<b>TF8369</b>	<i>From 8/06 Pump Only Can fit TF8144 if original Pump has been changed with TF8144H</i>	
Fan Clutch	<b>TFC219</b>		
Radiator Fan Blade	<b>TFB527</b>		
Timing Belt Kit	<b>TFK221</b>		
Timing Belt Kit	<b>TFK221H</b>	<i>Kit contains Hydraulic Tensioner</i>	
Timing Belt Kit with Water Pump	<b>TFK221P</b>	<i>To 8/06 Kit contains TF8144 Pump without Housing</i>	
Timing Belt Kit with Water Pump	<b>TFK221PC</b>	<i>To 8/06 Kit contains TF8144H Pump with Housing</i>	
Timing Belt Kit with Water Pump	<b>TFK221P2</b>	<i>From 8/06 Kit contains TF8369 Pump without Housing</i>	
<b>Hi-Lux KZN165 Turbo Diesel</b>			
		<b>1/98-3/05</b>	<b>4 Cyl 3.0L 1KZTE</b>
Water Pump	<b>TF8144</b>	<i>Without Housing Base</i>	
Water Pump	<b>TF8144H</b>	<i>With Housing Base</i>	
Fan Clutch	<b>TFC151</b>		
Radiator Fan Blade	<b>TFB503</b>		
Timing Belt Kit	<b>TFK153</b>		
Timing Belt Kit	<b>TFK153H</b>	<i>Kit contains Hydraulic Tensioner</i>	
Timing Belt Kit with Water Pump	<b>TFK153PC</b>	<i>Kit contains TF8144H Pump</i>	
Timing Belt Kit with Water Pump	<b>TFK153HPC</b>	<i>Kit contains TF8144H Pump and Hydraulic Tensioner</i>	
<b>Hi-Lux LN40, LN46 Diesel</b>			
		<b>1/79-10/86</b>	<b>4 Cyl 2.2L L</b>
Water Pump	<b>TF819</b>		
Fan Clutch	<b>TFC180</b>		
Timing Belt Kit	<b>TFK019</b>		

Description	Part No	Year & Notes	Engine
<b>TOYOTA</b>			
<b>Hi-Lux LN55 Diesel</b>			
		11/83-2/89	4 Cyl 2.2L L
Water Pump	TF819		
Fan Clutch	TFC180		
Radiator Fan Blade	TFB508	7 Blade Fan	
Timing Belt Kit	TFK019		
<b>Hi-Lux LN56 Diesel</b>			
		9/84-9/88	4 Cyl 2.4L 2L
Water Pump	TF1061		
Fan Clutch	TFC180		
Radiator Fan Blade	TFB508		
Timing Belt Kit	TFK019		
<b>Hi-Lux LN65 Diesel</b>			
		11/83-10/88	4 Cyl 2.4L 2L
Water Pump	TF1061		
Fan Clutch	TFC180		
Radiator Fan Blade	TFB520	To 8/84	
Radiator Fan Blade	TFB508	From 8/84	
Timing Belt Kit	TFK019		
<b>Hi-Lux LN85 Diesel</b>			
		10/88-10/97	4 Cyl 2.4L 2L
Water Pump	TF1061		
Fan Clutch	TFC180		
Radiator Fan Blade	TFB509		
<b>Hi-Lux LN86, 106, 107, 111 Diesel</b>			
		10/88-1/98	4 Cyl 2.8L 3L
Water Pump	TF3046		
Fan Clutch	TFC192		
Radiator Fan Blade	TFB509		
Timing Belt Kit	TFK020		
Timing Belt Kit with Water Pump	TFK020P	Kit contains TF3046 Pump	
<b>Hi-Lux LN147,167, 172 Diesel</b>			
		11/97-4/05	4 Cyl 3.0L 5L
Water Pump	TF3046		
Fan Clutch	TFC179		
Radiator Fan Blade	TFB511	To 8/01	
Radiator Fan Blade	TFB512	From 9/01	
Timing Belt Kit	TFK020		
Timing Belt Kit with Water Pump	TFK020P	Kit contains TF3046 Pump	
<b>Hi-Lux RN20</b>			
		1/72-1/78	4 Cyl 1.6L 12R
Water Pump	TF959	To 11/75	
Fan Clutch	TFC116		

Description	Part No	Year & Notes	Engine
<b>TOYOTA</b>			
<b>Hi-Lux RN41</b>			
		<b>1/78-10/83</b>	<b>4 Cyl 2.0L 18R</b>
Water Pump	<b>TF836A</b>	<i>From 9/79 Pump &amp; Hub only</i>	
Fan Clutch	<b>TFC116</b>	<i>From 9/79</i>	
<b>Hi-Lux RN46</b>			
		<b>4/79-11/81</b>	<b>4 Cyl 2.0L 18R</b>
Water Pump	<b>TF836A</b>	<i>From 9/79 Pump &amp; Hub only</i>	
Fan Clutch	<b>TFC116</b>	<i>From 9/79</i>	
Radiator Fan Blade	<b>TFB503</b>		
<b>Hi-Lux RN85 – RN110</b>			
		<b>10/88-12/97</b>	<b>4 Cyl 2.4L 22R</b>
Water Pump	<b>TF3045</b>		
Fan Clutch	<b>TFC130</b>		
Radiator Fan Blade	<b>TFB503</b>		
<b>Hi-Lux RZN147</b>			
		<b>11/97-10/02</b>	<b>4 Cyl 2.0L 1RZE</b>
Water Pump	<b>TF8147</b>		
Fan Clutch	<b>TFC142</b>		
<b>Hi-Lux RZN149, 154, 169, 174</b>			
		<b>11/97-4/05</b>	<b>4 Cyl 2.7L 3RZFE</b>
Water Pump	<b>TF4005</b>		
Fan Clutch	<b>TFC146</b>		
Radiator Fan Blade	<b>TFB502</b>	<i>7 Blade Fan</i>	
Timing Chain Kit	<b>TCK113</b>	<i>Kit without Gears</i>	
Timing Chain Kit	<b>TCK113G</b>	<i>Kit with Gears</i>	
<b>Hi-Lux RZN167</b>			
		<b>11/02-4/05</b>	<b>V6 3.4L 5VZFE</b>
Water Pump	<b>TF4006</b>		
Fan Clutch	<b>TFC184</b>		
Radiator Fan Blade	<b>TFB516</b>		
Timing Belt Kit	<b>TFK090</b>		
Timing Belt Kit with Water Pump	<b>TFK090P</b>	<i>Kit contains TF4006 Pump</i>	
<b>Hi-Lux TGN16</b>			
		<b>3/05-on</b>	<b>4 Cyl 2.7L 2TRFE</b>
Water Pump	<b>TF4005</b>		
Fan Clutch	<b>TFC185</b>		
Radiator Fan Blade	<b>TFB507</b>	<i>To 9/08</i>	
Radiator Fan Blade	<b>TFB516</b>	<i>From 9/08</i>	
<b>Hi-Lux YN55 – YN67</b>			
		<b>10/78-2/89</b>	<b>4 Cyl 1.6L, 1.8L, 2.0L, 2.2L 1Y, 2Y, 3Y, 4Y</b>
Water Pump	<b>TF894</b>		
Fan Clutch	<b>TFC116</b>		
Radiator Fan Blade	<b>TFB503</b>		

Description	Part No	Year & Notes	Engine
<b>TOYOTA</b>			
<b>Hi-Lux YN85</b>		<b>10/88-10/97</b>	<b>4 Cyl 1.8L 2Y</b>
Water Pump	<b>TF894</b>		
Fan Clutch	<b>TFC116</b>		
Radiator Fan Blade	<b>TFB505</b>		
<b>Hi-Lux VZN167, VZN172</b>		<b>10/02-3/05</b>	<b>V6 3.4L 5VZFE</b>
Water Pump	<b>TF4006</b>		
Fan Clutch	<b>TFC184</b>		
Radiator Fan Blade	<b>TFB516</b>		
<b>Kluger MCU28</b>		<b>11/03-on</b>	<b>V6 3.3L 3MZFE</b>
Water Pump	<b>TF9092</b>		
<b>Kluger GSU40, GSU45</b>		<b>8/07-on</b>	<b>V6 3.5L 2GRFE</b>
Water Pump	<b>TF8253</b>		
<b>LANDCRUISER - 40 SERIES</b>			
<b>Landcruiser BJ40 Diesel</b>		<b>12/77-9/80</b>	<b>4 Cyl 3.0L B</b>
Water Pump	<b>TF885</b>		
<b>Landcruiser BJ42 Diesel</b>		<b>6/80-12/84</b>	<b>4 Cyl 3.4L 3B</b>
Water Pump	<b>TF9075</b>		
Radiator Fan Blade	<b>TFB503</b>	<i>7 Blade Fan</i>	
<b>Landcruiser FJ40, FJ45, FJ55</b>		<b>11/72-12/84</b>	<b>6 Cyl 4.2L 2F</b>
Water Pump	<b>TF856</b>	<i>To 7/80</i>	
Water Pump	<b>TF3055</b>	<i>From 8/80 suits Models with Fan Clutch</i>	
Fan Clutch	<b>TFC175</b>		
Radiator Fan Blade	<b>TFB514</b>	<i>7 Blade Fan</i>	
Radiator Fan Blade	<b>TFB513</b>	<i>8 Blade Fan</i>	
<b>Landcruiser HJ45 Diesel</b>		<b>9/77-12/79</b>	<b>6 Cyl 3.6L H</b>
Water Pump	<b>TF887</b>		
Fan Clutch	<b>TFC107</b>	<i>Pulley holes Centre to Centre 60mm</i>	
<b>Landcruiser HJ47 Diesel</b>		<b>10/80-12/84</b>	<b>6 Cyl 4.0L 2H</b>
Water Pump	<b>TF896</b>		
Fan Clutch	<b>TFC107</b>	<i>Pulley holes Centre to Centre 60mm</i>	
Radiator Fan Blade	<b>TFB523</b>		



Description	Part No	Year & Notes	Engine
<b>TOYOTA</b>			
<b>LANDCRUISER – 60 SERIES</b>			
<b>Landcruiser FJ60</b>		<b>11/80-4/90</b>	<b>6 Cyl 4.2L 2F</b>
Water Pump	<b>TF3055</b>		
Fan Clutch	<b>TFC175</b>		
Radiator Fan Blade	<b>TFB514</b>	<i>7 Blade Fan</i>	
<b>Landcruiser FJ62</b>		<b>1/85-4/90</b>	<b>6 Cyl 4.0L 3F</b>
Water Pump	<b>TF1220</b>	<i>With Manual Transmission</i>	
Water Pump	<b>TF3051</b>	<i>With Auto Transmission without Oil Cooler &amp; Fixed Fan</i>	
Water Pump	<b>TF3052</b>	<i>With Auto Transmission with Oil Cooler &amp; Fan Clutch</i>	
Fan Clutch	<b>TFC175</b>		
Radiator Fan Blade	<b>TFB514</b>	<i>7 Blade Fan</i>	
<b>Landcruiser HJ60, HJ61 Diesel</b>		<b>11/80-4/90</b>	<b>6 Cyl 4.0L 2H, 12HT</b>
Water Pump	<b>TF896</b>		
Fan Clutch	<b>TFC107</b>	<i>Pulley holes Centre to Centre 60mm</i>	
Radiator Fan Blade	<b>TFB522</b>		
<b>LANDCRUISER – 70 SERIES</b>			
<b>Landcruiser BJ70, BJ73, BJ74 Diesel</b>		<b>1/85-2/90</b>	<b>4 Cyl 3.4L 3B, 13BT</b>
Water Pump	<b>TF3068</b>		
Fan Clutch	<b>TFC107</b>	<i>Pulley holes Centre to Centre 60mm</i>	
<b>Landcruiser FJ70, FJ73, FJ75</b>		<b>1/85-10/92</b>	<b>6 Cyl 4.0L 3F</b>
Water Pump	<b>TF1220</b>	<i>With Manual Transmission</i>	
Water Pump	<b>TF3051</b>	<i>With Auto Transmission without Oil Cooler &amp; Fixed Fan</i>	
Water Pump	<b>TF3052</b>	<i>With Auto Transmission with Oil Cooler &amp; Fan Clutch</i>	
Fan Clutch	<b>TFC175</b>		
Radiator Fan Blade	<b>TFB514</b>	<i>7 Blade Fan</i>	
<b>Landcruiser FZJ75, FZJ78, FZJ79</b>		<b>11/92-3/07</b>	<b>6 Cyl 4.5L 1FZE</b>
Water Pump	<b>TF4009</b>		
Fan Clutch	<b>TFC144</b>	<i>Pulley holes Centre to Centre 64mm</i>	
Radiator Fan Blade	<b>TFB519</b>		
<b>Landcruiser HDJ78, HDJ79 Turbo Diesel</b>		<b>11/01-3/07</b>	<b>6 Cyl 4.2L 1HDFTE</b>
Water Pump	<b>TF3106</b>		
Fan Clutch	<b>TFC106</b>	<i>Pulley holes Centre to Centre 62mm</i>	
Radiator Fan Blade	<b>TFB522</b>		
Timing Belt Kit	<b>TFK171</b>		

Description	Part No	Year & Notes	Engine
<b>TOYOTA</b>			
<b>LANDCRUISER – 70 SERIES (cont)</b>			
<b>Landcruiser HJ75 Diesel</b>			
		<b>1/85-3/90</b>	<b>6 Cyl 4.0L 2H</b>
Water Pump	<b>TF896</b>		
Fan Clutch	<b>TFC107</b>	<i>Pulley holes Centre to Centre 60mm</i>	
Radiator Fan Blade	<b>TFB522</b>		
<b>Landcruiser HZJ70, HZJ73, HZJ75 Diesel</b>			
		<b>1/90-10/99</b>	<b>6 Cyl 4.2L 1HZ</b>
Water Pump	<b>TF3106</b>		
Fan Clutch	<b>TFC106</b>	<i>Pulley holes Centre to Centre 62mm</i>	
Radiator Fan Blade	<b>TFB500</b>		
Timing Belt Kit	<b>TFK083</b>	<i>To 5/98</i>	
Timing Belt Kit	<b>TFK170</b>	<i>From 6/98</i>	
Timing Belt Kit	<b>TFK170H</b>	<i>From 6/98 Kit contains Hydraulic Tensioner</i>	
Timing Belt Kit with Water Pump	<b>TFK083P</b>	<i>To 5/98 Kit contains TF3106 Pump</i>	
<b>Landcruiser HZJ78, HZJ79 Diesel</b>			
		<b>10/99-3/07</b>	<b>6 Cyl 4.2L 1HZ</b>
Water Pump	<b>TF3106</b>		
Fan Clutch	<b>TFC106</b>	<i>Pulley holes Centre to Centre 62mm</i>	
Radiator Fan Blade	<b>TFB522</b>		
Timing Belt Kit	<b>TFK170</b>		
Timing Belt Kit	<b>TFK170H</b>	<i>Kit contains Hydraulic Tensioner</i>	
<b>Landcruiser PZJ70, PZJ73 Diesel</b>			
		<b>3/90-2/91</b>	<b>5 Cyl 3.5L 1PZ</b>
Water Pump	<b>TF3106</b>		
Fan Clutch	<b>TFC106</b>	<i>Pulley holes Centre to Centre 62mm</i>	
Radiator Fan Blade	<b>TFB500</b>		
<b>Landcruiser VDJ76, VDJ78, VDJ79</b>			
		<b>3/07-on</b>	<b>V8 4.5L 1VDFTV</b>
Water Pump	<b>TF8373</b>		
Water Pump Fan Bracket	<b>TF8373FB</b>		
Fan Clutch	<b>TFC232</b>		
Radiator Fan Blade	<b>TFB551</b>		

Description	Part No	Year & Notes	Engine
<b>TOYOTA</b>			
<b>LANDCRUISER – 80 SERIES</b>			
<b>Landcruiser FJ80</b>		<b>12/89-8/92</b>	<b>6 Cyl 4.0L 3F, 3FE</b>
Water Pump	<b>TF3052</b>	<i>Automatic Transmission with Oil Cooler &amp; Fan Clutch</i>	
Fan Clutch	<b>TFC175</b>		
Radiator Fan Blade	<b>TFB514</b>		
<b>Landcruiser FZJ80</b>		<b>11/92-2/98</b>	<b>6 Cyl 4.5L 1FZE</b>
Water Pump	<b>TF4009</b>		
Fan Clutch	<b>TFC144</b>	<i>Pulley holes Centre to Centre 64mm</i>	
<b>Landcruiser FZJ80</b>		<b>5/90-12/98</b>	<b>6 Cyl 4.5L 1FZFE</b>
Radiator Fan Blade	<b>TFB519</b>		
<b>Landcruiser HDJ80 Turbo Diesel</b>		<b>5/90-3/95</b>	<b>6 Cyl 4.2L 1HDT, 1HDFT</b>
Water Pump	<b>TF3106</b>		
Fan Clutch	<b>TFC106</b>	<i>Pulley holes Centre to Centre 62mm</i>	
Radiator Fan Blade	<b>TFB500</b>		
<b>Landcruiser HZJ80 Diesel</b>		<b>11/90-3/98</b>	<b>6 Cyl 4.2L 1HZ</b>
Water Pump	<b>TF3106</b>		
Fan Clutch	<b>TFC106</b>	<i>Pulley holes Centre to Centre 62mm</i>	
Radiator Fan Blade	<b>TFB500</b>		
<b>LANDCRUISER – 100 SERIES</b>			
<b>Landcruiser FZJ105</b>		<b>3/98-10/02</b>	<b>6 Cyl 4.5L 1FZE</b>
Water Pump	<b>TF4009</b>		
Fan Clutch	<b>TFC144</b>	<i>Pulley holes Centre to Centre 64mm</i>	
Radiator Fan Blade	<b>TFB516</b>		
Timing Chain Kit	<b>TCK114</b>	<i>Kit without Gears</i>	
Timing Chain Kit	<b>TCK114G</b>	<i>Kit with Gears</i>	
<b>Landcruiser HDJ100 Turbo Diesel</b>		<b>10/02-1/08</b>	<b>6 Cyl 4.2L 1HDFT</b>
Water Pump	<b>TF3106</b>		
<b>Landcruiser HDJ100 Turbo Diesel</b>		<b>10/00-1/08</b>	<b>6 Cyl 4.2L 1HDFT</b>
Radiator Fan Blade	<b>TFB522</b>		
Timing Belt Kit	<b>TFK171H</b>	<i>Kit contains Hydraulic Tensioner</i>	

Description	Part No	Year & Notes	Engine
<b>TOYOTA</b>			
<b>LANDCRUISER – 100 SERIES (cont)</b>			
<b>Landcruiser HZJ105 Diesel</b>		<b>3/98-1/08</b>	<b>6 Cyl 4.2L 1HZ</b>
Water Pump	<b>TF3106</b>		
Fan Clutch	<b>TFC176</b>		
Radiator Fan Blade	<b>TFB522</b>		
<b>Landcruiser UZJ100</b>		<b>3/98-1/08</b>	<b>V8 4.7L 2UZFE</b>
Water Pump	<b>TF8143</b>		
Water Pump Fan Bracket	<b>TF8143FB</b>		
Fan Clutch	<b>TFC216</b>		
Radiator Fan Blade	<b>TFB506</b>		
<b>LANDCRUISER – 200 SERIES</b>			
<b>Landcruiser VDJ200</b>		<b>11/07-on</b>	<b>V8 4.5L 1VDFTV</b>
Water Pump	<b>TF8373</b>		
Water Pump Fan Bracket	<b>TF8373FB</b>		
Fan Clutch	<b>TFC232</b>		
Radiator Fan Blade	<b>TFB551</b>		
<b>Landcruiser UZJ200</b>		<b>11/07-on</b>	<b>V8 4.7L 2UZFE</b>
Water Pump	<b>TF8143</b>		
Water Pump Fan Bracket	<b>TF8143FB</b>		
Fan Clutch	<b>TFC226</b>		
Radiator Fan Blade	<b>TFB551</b>		
<b>Lexcen VN</b>		<b>9/89-11/91</b>	<b>V6 3.8L</b>
Water Pump	<b>TF9000</b>	<i>Multifit Pump</i>	
Water Pump	<b>TF1039</b>	<i>OE Replacement can use TF9000 Multifit Pump</i>	
<b>Lexcen VP, VR</b>		<b>11/91-4/95</b>	<b>V6 3.8L</b>
Water Pump	<b>TF9000</b>	<i>Multifit Pump</i>	
Water Pump	<b>TF3000</b>	<i>OE Replacement can use TF9000 Multifit Pump</i>	
<b>Lexcen VS</b>		<b>5/95-4/97</b>	<b>V6 3.8L</b>
Water Pump	<b>TF9000</b>	<i>Multifit Pump</i>	
Water Pump	<b>TF4000</b>	<i>To Engine No. VH515478 OE Replacement</i>	
Water Pump	<b>TF4001</b>	<i>From Engine No. VH515479 OE Replacement</i>	

Description	Part No	Year & Notes	Engine
<b>TOYOTA</b>			
<b>Lite-Ace CM20, CM35 Diesel</b>			
		1/83-1/89	4 Cyl 1.8L 1C
Water Pump	TF1200		
Radiator Fan Blade	TFB503	7 Blade Fan	
<b>Lite-Ace KM36</b>			
		1/86-3/92	4 Cyl 1.5L 5KC
Water Pump	TF1210		
Fan Clutch	TFC221		
Radiator Fan Blade	TFB503	7 Blade Fan	
<b>Lite-Ace YM21, YM30, YM35</b>			
		1/84-3/92	4 Cyl 1.8L 2Y
Water Pump	TF894		
Fan Clutch	TFC116		
Radiator Fan Blade	TFB503	7 Blade Fan	
<b>Lite-Ace YM40, YM41</b>			
		3/86-9/88	4 Cyl 2.0L 3YC
Water Pump	TF894		
Fan Clutch	TFC116		
<b>MR2 AW11</b>			
		10/87-2/90	4 Cyl 1.6L 4AGE
Water Pump	TF1063		
<b>MR2 SW20</b>			
		3/90-8/99	4 Cyl 2.0L 3SGE
Water Pump	TF3041	Pump without Housing	
Water Pump	TF3041H	Pump with Housing	
<b>MR2 ZZW30</b>			
		10/00-3/06	4 Cyl 1.8L 1ZZFE
Water Pump	TF7011		
<b>Paseo EL44, EL54</b>			
		7/91-12/99	4 Cyl 1.5L 5EFE
Water Pump	TF3085	Pump without Pulley	
Water Pump	TF3085P	Pump with Pulley	
<b>Prado GRJ120</b>			
		2/03-on	V6 4.0L 1GRFE
Water Pump	TF8272		
Fan Clutch	TFC156		
Radiator Fan Blade	TFB539		
Thermostat & Housing	TTH550		
<b>Prado GRJ150</b>			
		11/09-on	V6 4.0L 1GRFE
Water Pump	TF8483		
Radiator Fan Blade	TFB539		
Thermostat & Housing	TTH550		



Description	Part No	Year & Notes	Engine
<b>TOYOTA</b>			
<b>Prado KDJ120</b>			
		<b>11/06-on</b>	<b>4 Cyl 3.0L 1KDFTV</b>
Water Pump	<b>TF8144</b>	<i>Without Housing Base</i>	
Water Pump	<b>TF8144H</b>	<i>With Housing Base</i>	
Fan Clutch	<b>TFC225</b>		
Radiator Fan Blade	<b>TFB520</b>	<i>7 Blade Fan</i>	
Timing Belt Kit	<b>TFK221</b>		
Timing Belt Kit	<b>TFK221H</b>	<i>Kit contains Hydraulic Tensioner</i>	
Timing Belt Kit with Water Pump	<b>TFK221P</b>	<i>Kit contains TF8144 Pump</i>	
Timing Belt Kit with Water Pump	<b>TFK221PC</b>	<i>Kit contains TF8144H Pump</i>	
<b>Prado KDJ150, KDJ155</b>			
		<b>11/09-on</b>	<b>4 Cyl 3.0L 1KDFTV</b>
Water Pump	<b>TF8144</b>	<i>Without Housing Base</i>	
Water Pump	<b>TF8144H</b>	<i>With Housing Base</i>	
Fan Clutch	<b>TFC225</b>		
Radiator Fan Blade	<b>TFB520</b>	<i>7 Blade Fan</i>	
Timing Belt Kit	<b>TFK221</b>		
Timing Belt Kit	<b>TFK221H</b>	<i>Kit contains Hydraulic Tensioner</i>	
Timing Belt Kit with Water Pump	<b>TFK221P</b>	<i>Kit contains TF8144 Pump</i>	
Timing Belt Kit with Water Pump	<b>TFK221PC</b>	<i>Kit contains TF8144H Pump with Housing</i>	
<b>Prado KZJ95, KZJ120 Turbo Diesel</b>			
		<b>3/00-11/06</b>	<b>4 Cyl 3.0L 1KZTE</b>
Water Pump	<b>TF8144</b>	<i>Without Housing Base</i>	
Water Pump	<b>TF8144H</b>	<i>With Housing Base</i>	
Fan Clutch	<b>TFC151</b>		
Radiator Fan Blade	<b>TFB520</b>	<i>7 Blade Fan</i>	
Timing Belt Kit	<b>TFK153</b>		
Timing Belt Kit	<b>TFK153H</b>	<i>Kit contains Hydraulic Tensioner</i>	
Timing Belt Kit with Water Pump	<b>TFK153PC</b>	<i>Kit contains TF8144H Pump with Housing</i>	
Timing Belt Kit with Water Pump	<b>TFK153HPC</b>	<i>Kit contains TF8144H Pump and Hydraulic Tensioner</i>	
<b>Prado RZJ95, RZJ120</b>			
		<b>7/96-8/04</b>	<b>4 Cyl 2.7L 3RZFE</b>
Water Pump	<b>TF4005</b>		
Fan Clutch	<b>TFC146</b>		
Radiator Fan Blade	<b>TFB502</b>	<i>7 Blade Fan</i>	
<b>Prado VZJ95</b>			
		<b>7/96-2/03</b>	<b>V6 3.4L 5VZFE</b>
Water Pump	<b>TF4006</b>		
Fan Clutch	<b>TFC169</b>		
Radiator Fan Blade	<b>TFB516</b>		
Timing Belt Kit	<b>TFK090</b>		
Timing Belt Kit with Water Pump	<b>TFK090P</b>	<i>Kit contains TF4006 Pump</i>	

Description	Part No	Year & Notes	Engine
<b>TOYOTA</b>			
<b>Prius NHW11, NWH20</b>		<b>10/01-on</b>	<b>4 Cyl 1.5L 1NZFXE</b>
Water Pump	<b>TF4010</b>		
<b>Prius ZVW30</b>		<b>7/09-on</b>	<b>4 Cyl 1.8L 2ZRFE</b>
Water Pump	<b>TF8440</b>		
Inverter Water Pump	<b>TF8453</b>	<i>Inverter Pump</i>	
<b>RAV4 ACA20, ACA21, ACA33</b>		<b>7/00-on</b>	<b>4 Cyl 2.0L, 2.4L 1AZFE, 2AZFE</b>
Water Pump	<b>TF8227</b>		
<b>RAV4 ACA38</b>		<b>1/10-on</b>	<b>4 Cyl 2.4L 2AZFE</b>
Water Pump	<b>TF8227</b>		
<b>RAV4 GSA33</b>		<b>10/07-on</b>	<b>6 Cyl 3.5L 2GRFE</b>
Water Pump	<b>TF8253</b>		
<b>RAV4 SXA10, SXA11</b>		<b>7/94-7/00</b>	<b>4 Cyl 2.0L 3SFE</b>
Water Pump	<b>TF3047</b>	<i>Pump without Housing</i>	
Water Pump	<b>TF3047H</b>	<i>Pump with Housing</i>	
Radiator Fan Blade	<b>TFB533</b>		
Timing Belt Kit	<b>TFK013</b>		
Timing Belt Kit with Water Pump	<b>TFK013P</b>	<i>Kit contains TF3047 Pump without Housing</i>	
Timing Belt Kit with Water Pump	<b>TFK013PC</b>	<i>Kit contains TF3047H Pump with Housing</i>	
<b>RAV 4 ALA49 Turbo Diesel</b>		<b>2/13-on</b>	<b>4 Cyl 2.2L 2ADFTV</b>
Water Pump	<b>TF8473</b>		
<b>Rukus AZE151</b>		<b>5/10-on</b>	<b>4 Cyl 2.4L 2AZFE</b>
Water Pump	<b>TF8469</b>		
<b>Soarer JZZ30 Import</b>		<b>1/90-12/97</b>	<b>6 Cyl 2.5L 1JZGTE</b>
Water Pump	<b>TF8149</b>	<i>To 6/96 Check Identification Guide</i>	
Water Pump	<b>TF8150</b>	<i>From 7/96 check Identification Guide</i>	
<b>Soarer JZS151 Import</b>		<b>1995-on</b>	<b>6 Cyl 3.0L 2JZGE</b>
Water Pump	<b>TF8281</b>		

Description	Part No	Year & Notes	Engine
<b>TOYOTA</b>			
<b>Spacia SR40</b>			
		9/00-1/01	4 Cyl 2.0L 3SFE
Water Pump	TF3047	<i>Pump without Housing</i>	
Water Pump	TF3047H	<i>Pump with Housing</i>	
Fan Clutch	TFC220		
Radiator Fan Blade	TFB530		
Timing Belt Kit	TFK013		
Timing Belt Kit with Water Pump	TFK013P	<i>Kit contains TF3047 Pump without Housing</i>	
Timing Belt Kit with Water Pump	TFK013PC	<i>Kit contains TF3047H Pump with Housing</i>	
<b>Spacia YR22</b>			
		10/93-1/98	4 Cyl 2.2L 4YEC
Water Pump	TF894		
Fan Clutch	TFC116		
Radiator Fan Blade	TFB534		
<b>Starlet EP91R</b>			
		4/96-10/99	4 Cyl 1.3L 4EFE
Water Pump	TF3085P	<i>Pump with Pulley</i>	
Water Pump	TF8213	<i>Complete Pump with Pulley &amp; Housing</i>	
Timing Belt Kit	TFK111		
<b>Stout RK101</b>			
		1/70-1976	4 Cyl 2.0L 5R
Water Pump	TF731		
<b>Stout RK110</b>			
		4/79-12/83	4 Cyl 2.0L 5R
Water Pump	TF858		
<b>Supra MA61</b>			
		10/83-1/87	6 Cyl 2.8L 5ME
Water Pump	TF1055		
Fan Clutch	TFC112		
<b>Supra MA70</b>			
		1/87-10/88	6 Cyl 3.0L 7MGE
Water Pump	TF3042		
Radiator Fan Blade	TFB504		
<b>Supra MA71 Turbo</b>			
		10/88-4/93	6 Cyl 3.0L 7MGTE
Water Pump	TF3042		
<b>Supra JZA80 Import</b>			
		1/93-12/97	6 Cyl 3.0L 2JZGE
Water Pump	TF8149		
<b>Tarago AC30, AC50</b>			
		6/00-on	4 Cyl 2.4L 2AZFE
Water Pump	TF8227		

Description	Part No	Year & Notes	Engine
<b>TOYOTA</b>			
<b>Tarago CR21 Diesel</b>		<b>7/83-9/88</b>	<b>4 Cyl 2.0L 2C</b>
Water Pump	<b>TF1200</b>		
Radiator Fan Blade	<b>TFB503</b>	<i>7 Blade Fan</i>	
<b>Tarago GS50</b>		<b>2/07-on</b>	<b>V6 3.5L 2GRFE</b>
Water Pump	<b>TF8253</b>		
<b>Tarago TCR10, 11, 20, 21</b>		<b>9/90-10/93</b>	<b>4 Cyl 2.4L 2TZFE</b>
Water Pump	<b>TF3132</b>		
Fan Clutch	<b>TFC132</b>		
Radiator Fan Blade	<b>TFB524</b>		
<b>Tarago YR20, YR21</b>		<b>2/83-12/90</b>	<b>4 Cyl 1.8L, 2.0L 2Y, 3YC</b>
Water Pump	<b>TF894</b>		
Fan Clutch	<b>TFC116</b>		
Radiator Fan Blade	<b>TFB503</b>	<i>7 Blade Fan</i>	
<b>Tarago YR22, YR31</b>		<b>3/84-12/90</b>	<b>4 Cyl 2.2L 4YEC</b>
Water Pump	<b>TF894</b>		
Fan Clutch	<b>TFC116</b>		
Radiator Fan Blade	<b>TFB503</b>	<i>To 8/87</i>	
Radiator Fan Blade	<b>TFB534</b>	<i>From 8/87</i>	
<b>Townace KR42</b>		<b>2/97-4/04</b>	<b>4 Cyl 1.8L 7KC, 7KE</b>
Water Pump	<b>TF8139</b>		
Fan Clutch	<b>TFC221</b>		
Radiator Fan Blade	<b>TFB503</b>	<i>7 Blade Fan</i>	
<b>Townace YR39</b>		<b>4/92-1/97</b>	<b>4 Cyl 2.0L 3YC</b>
Water Pump	<b>TF894</b>		
Fan Clutch	<b>TFC116</b>		
Radiator Fan Blade	<b>TFB534</b>		
<b>Toyo-Ace LY30 Diesel</b>		<b>3/82-8/83</b>	<b>4 Cyl 2.2L L</b>
Water Pump	<b>TF819</b>		
<b>Toyo-Ace LY31 Diesel</b>		<b>9/83-12/85</b>	<b>4 Cyl 2.4L 2L</b>
Water Pump	<b>TF1061</b>		
Fan Clutch	<b>TFC180</b>		
<b>Toyo-Ace RY16, RY31</b>		<b>1968-12/85</b>	<b>4 Cyl 2.0L 5R</b>
Water Pump	<b>TF847</b>		

Description	Part No	Year & Notes	Engine
<b>TOYOTA</b>			
<b>Yaris NCP90, 91, 93</b>		11/05-on	4 Cyl 1.3L, 1.5L 1NZFE, 2NZFE
<i>Water Pump</i>	<b>TF4010</b>		
<b>VOLKSWAGEN</b>			
<b>Amarok 2H Diesel</b>		1/11-On	4 Cyl 2.0L CDCA
<i>Water Pump</i>	<b>TF8472</b>		
<b>Beetle 9C</b>		1/02-10/11	4 Cyl 1.6L AKL, AYD
<i>Water Pump</i>	<b>TF8132</b>		
<b>Beetle 9C incl. Turbo</b>		9/01-on	4 Cyl 1.8L, 2.0L AWU, AQY, APK
<i>Water Pump</i>	<b>TF8131</b>		
<b>Bora 1J</b>		12/99-11/05	4 Cyl 2.0L APK
<i>Water Pump</i>	<b>TF8131</b>		
<b>Bora 1J,V5</b>		12/99-11/05	V5 2.3L AGZ, AQN
<i>Water Pump</i>	<b>TF8133</b>		
<b>Bora 1J</b>		6/01-11/05	V6 2.8L AUE, BDE
<i>Water Pump</i>	<b>TF8310</b>		
<b>Caddy Van</b>		1/06-on	4 Cyl 1.6L BGU, BSE
<i>Water Pump</i>	<b>TF8132</b>		
<b>Caddy Van Turbo Diesel</b>		1/06-on	4 Cyl 1.9L BJB, BLS
<i>Water Pump</i>	<b>TF8314</b>		
<b>Caravelle</b>		1984-12/92	4 Cyl 2.1L DJ, MV
<i>Water Pump</i>	<b>TF8237</b>		
<b>Caravelle</b>		1/93-4/05	5 Cyl 2.5L AET
<i>Water Pump</i>	<b>TF8134</b>		
<b>Caravelle Turbo Diesel</b>		8/00-4/05	5 Cyl 2.5L ACV
<i>Water Pump</i>	<b>TF8134</b>		
<b>Caravelle T5 Turbo Diesel</b>		2/08-on	5 Cyl 2.5L BNZ, BPC
<i>Water Pump</i>	<b>TF8318</b>		
<b>Caravelle</b>		12/02-4/05	5 Cyl 2.8L AMV
<i>Water Pump</i>	<b>TF8103</b>		



Description	Part No	Year & Notes	Engine
<b>VOLKSWAGEN</b>			
<b>Citivan T5 Turbo Diesel</b>		10/06-On	4 Cyl 1.9L BRR, BRS
<i>Water Pump</i>	<b>TF8314</b>		
<b>Citivan T5 Petrol</b>		10/06-On	4 Cyl 2.0L AXA
<i>Water Pump</i>	<b>TF8131</b>		
<b>EOS FSI</b>		3/07-8/08	4 Cyl 2.0L BWA
<i>Water Pump</i>	<b>TF8385</b>		
<i>Thermostat &amp; Housing</i>	<b>TTH518</b>		
<b>EOS TDi Turbo Diesel</b>		3/07-on	4 Cyl 2.0L BMM
<i>Water Pump</i>	<b>TF8402</b>		
<b>Golf VI</b>		9/10-on	4 Cyl 1.2L CBZB
<i>Water Pump</i>	<b>TF8489</b>		
<i>Thermostat &amp; Housing</i>	<b>TTH594</b>		
<b>Golf 90TSi Trendline Turbo Diesel</b>		2/09-on	4 Cyl 1.4L CAXA
<i>Water Pump</i>	<b>TF8475</b>		
<i>Thermostat Repair Kit &amp; Housing</i>	<b>TTH582</b>		
<b>Golf GL Rally, GL, S/SE, A5 Petrol</b>		10/98-12/09	4 Cyl 1.6L AEH, AKL, BFQ, BGU
<i>Water Pump</i>	<b>TF8132</b>		
<b>Golf A5, Comfortline, Trendline Petrol</b>		8/07-3/09	4 Cyl 1.6L BSE
<i>Water Pump</i>	<b>TF8132</b>		
<b>Golf 77 TDi Trendline, VI Turbo Diesel</b>		8/09-on	4 Cyl 1.6L CAYC
<i>Water Pump</i>	<b>TF8455</b>		
<i>Thermostat &amp; Housing</i>	<b>TTH580</b>		
<b>Golf CL Petrol</b>		8/90-11/99	4 Cyl 1.8L ADZ
<i>Water Pump</i>	<b>TF2453</b>		
<b>Golf incl. GTi Petrol</b>		1/98-8/04	4 Cyl 1.8L AGN, AGU
<i>Water Pump</i>	<b>TF8131</b>		
<b>Golf GL, TDi Turbo Diesel</b>		10/95-5/98	4 Cyl 1.9L IZ
<i>Water Pump</i>	<b>TF2453</b>		
<b>Golf TDi Comfortline, Trendline Turbo Diesel</b>		8/04-7/08	4 Cyl 1.9L BKC
<i>Water Pump</i>	<b>TF8314</b>		

Description	Part No	Year & Notes	Engine
<b>VOLKSWAGEN</b>			
<b>Golf A5 Turbo Diesel</b>		8/07-3/09	4 Cyl 1.9L BXE
<i>Water Pump</i>	<b>TF8314</b>		
<b>Golf GL Petrol</b>		3/95-2/04	4 Cyl 2.0L AGG
<i>Water Pump</i>	<b>TF2453</b>		
<b>Golf GLE Petrol</b>		1/99-8/04	4 Cyl 2.0L AGY
<i>Water Pump</i>	<b>TF8131</b>		
<b>Golf Generation, GLE Petrol</b>		11/98-8/04	4 Cyl 2.0L APK
<i>Water Pump</i>	<b>TF8131</b>		
<b>Golf FSi Comfortline, Fsi Sportline, V Petrol</b>		8/04-1/10	4 Cyl 2.0L BLX
<i>Water Pump</i>	<b>TF8132</b>		
<b>Golf A5, V Petrol</b>		10/06-1/10	4 Cyl 2.0L AXX
<i>Water Pump</i>	<b>TF8385</b>		
<i>Thermostat &amp; Housing</i>	<b>TTH518</b>		
<b>Golf TDi Comfortline, A5 Turbo Diesel</b>		8/04-3/10	4 Cyl 2.0L BKD
<i>Water Pump</i>	<b>TF8402</b>	<i>To 3/09</i>	
<i>Water Pump</i>	<b>TF8455</b>	<i>From 4/09</i>	
<i>Thermostat &amp; Housing</i>	<b>TTH593</b>		
<b>Golf A5 Petrol</b>		8/07-3/09	4 Cyl 2.0L BVY
<i>Water Pump</i>	<b>TF8132</b>		
<i>Thermostat &amp; Housing</i>	<b>TTH535</b>		
<b>Golf A5 incl. GTi</b>		5/05-on	4 Cyl 2.0L BWA
<i>Water Pump</i>	<b>TF8385</b>		
<i>Thermostat &amp; Housing</i>	<b>TTH518</b>		
<b>Golf A5 GTTDI</b>		8/07-5/10	4 Cyl 2.0L BMN
<i>Water Pump</i>	<b>TF8427</b>		
<b>Golf A5 Gti Pirelli</b>		10/08-9/09	4 Cyl 2.0L BYD
<i>Water Pump</i>	<b>TF8385</b>		
<b>Golf VI</b>		1/10-on	4 Cyl 2.0L CBAB
<i>Water Pump</i>	<b>TF8402</b>		
<i>Thermostat &amp; Housing</i>	<b>TTH593</b>		
<b>Golf VI Petrol</b>		8/11-on	4 Cyl 2.0L CCZB
<i>Water Pump</i>	<b>TF8456</b>		

Description	Part No	Year & Notes	Engine
<b>VOLKSWAGEN</b>			
<b>Golf VR6</b>		3/94-10/98	4 Cyl 2.8L AAA
Water Pump	TF8103		
<b>Golf R32, A5</b>		9/03-on	4 Cyl 3.2L BUB
Water Pump	TF8310		
<b>Jetta 1KM 77TDi Turbo Diesel</b>		11/09-on	4 Cyl 1.6L CAYC
Water Pump	TF8402		
<b>Jetta 1KM,TDi Turbo Diesel</b>		2/06-2/09	4 Cyl 2.0L BKD
Water Pump	TF8402	From 7/06 & Vin No. 1K-6-899001	
<b>Jetta 1KM Petrol</b>		2/06-2/09	4 Cyl 2.0L BVY
Water Pump	TF8132		
Thermostat & Housing	TTH535		
<b>Jetta 1KM FSi Turbo Petrol</b>		2/06-2/09	4 Cyl 2.0L BWA
Water Pump	TF8385		
Thermostat & Housing	TTH518		
<b>Jetta 147TSI Turbo Petrol</b>		2/09-on	4 Cyl 2.0L BGB
Water Pump	TF8456		
<b>Jetta 1KM 103TDi</b>		2/09-on	4 Cyl 2.0L
Water Pump	TF8402		
Thermostat & Housing	TTH592		
<b>Kombi</b>		1986-92	4 Cyl 2.1L
Water Pump	TF8237		
<b>Kombi</b>		2/03-9/05	5 Cyl 2.5L AXA, AET
Water Pump	TF8134	To 6/03 With AET Engine	
Water Pump	TF8131	From 6/03 with AXA Engine	
<b>Kombi T5 Turbo Diesel</b>		2/06-12/08	5 Cyl 2.5L AXD
Water Pump	TF8318		
<b>Multivan T5 Turbo Diesel</b>		4/05-6/07	5 Cyl 2.5L AXE
Water Pump	TF8318		
Thermostat & Housing	TTH547		
<b>Multivan T5 Turbo Diesel</b>		6/04-on	5 Cyl 2.5L BPC
Water Pump	TF8318		

Description	Part No	Year & Notes	Engine
<b>VOLKSWAGEN</b>			
<b>Multivan T5 Petrol</b>		1/04-on	V6 3.2L BKK, BUB
<i>Water Pump</i>	<b>TF8310</b>		
<b>Passat 3B incl. Turbo</b>		3/98-11/02	4 Cyl 1.8L AEB, ADR
<i>Water Pump</i>	<b>TF8126</b>	<i>Pump without Housing</i>	
<i>Water Pump</i>	<b>TF4829</b>	<i>Pump with Housing</i>	
<b>Passat GP Turbo Petrol</b>		1/02-12/02	4 Cyl 1.8L AWT
<i>Water Pump</i>	<b>TF8131</b>		
<b>Passat</b>		8/95-4/98	4 Cyl 2.0L ADY
<i>Water Pump</i>	<b>TF2453</b>		
<b>Passat TDi Turbo Diesel</b>		3/06-on	4 Cyl 2.0L BKP
<i>Water Pump</i>	<b>TF8402</b>		
<b>Passat FSi Turbo Petrol</b>		3/06-8/08	4 Cyl 2.0L BWA
<i>Water Pump</i>	<b>TF8385</b>		
<i>Thermostat &amp; Housing</i>	<b>TTH518</b>		
<b>Passat V5</b>		1/02-11/05	5 Cyl 2.3L AGZ, AZX
<i>Water Pump</i>	<b>TF8133</b>		
<b>Passat 3B</b>		8/95-12/04	V6 2.8L AAA, ACK
<i>Water Pump</i>	<b>TF8135</b>		
<b>Passat 3B</b>		2/99-8/05	V6 2.8L APR, BBG
<i>Water Pump</i>	<b>TF4762</b>		
<b>Passat</b>		1/01-1/06	V6 2.8L AMX
<i>Water Pump</i>	<b>TF4762</b>		
<b>Passat FSi</b>		3/06-on	V6 3.2L AXZ
<i>Water Pump</i>	<b>TF8310</b>		
<b>Passat R36, FSi</b>		6/08-on	V6 3.6L BWS
<i>Water Pump</i>	<b>TF8310</b>		
<b>Polo 6R, 77TSi</b>		9/10-on	4 Cyl 1.2L CBZB
<i>Water Pump</i>	<b>TF8489</b>		
<i>Thermostat &amp; Housing</i>	<b>TTH594</b>		

Description	Part No	Year & Notes	Engine
<b>VOLKSWAGEN</b>			
<b>Polo 6N, 9N</b>		9/00-on	4 Cyl 1.4L AHW, BBY, BBZ, BUD
<i>Water Pump</i>	<b>TF8130</b>		
<i>Thermostat &amp; Housing</i>	<b>TTH520</b>		
<i>Thermostat Repair Kit &amp; Housing</i>	<b>TTH581</b>		
<b>Polo</b>		12/96-9/00	4 Cyl 1.6L AEE
<i>Water Pump</i>	<b>TF8128</b>		
<i>Thermostat &amp; Housing</i>	<b>TTH520</b>		
<i>Thermostat Repair Kit &amp; Housing</i>	<b>TTH581</b>		
<b>Polo 9N incl. GTi</b>		3/04-8/10	4 Cyl 1.6L BCD, BJX
<i>Water Pump</i>	<b>TF8131</b>		
<b>Polo Petrol</b>		8/07-on	4 Cyl 1.6L BTS
<i>Water Pump</i>	<b>TF8418</b>		
<b>Polo Turbo Diesel</b>		10/05-on	4 Cyl 1.9L AXR
<i>Water Pump</i>	<b>TF8314</b>		
<b>Tiguan 5N, 125 Petrol</b>		5/08-on	4 Cyl 2.0L AXX, CAWA
<i>Water Pump</i>	<b>TF8456</b>		
<i>Thermostat Repair Kit &amp; Housing</i>	<b>TTH585</b>		
<b>Tiguan Turbo Diesel</b>		5/08-on	4 Cyl 2.0L CBBB
<i>Water Pump</i>	<b>TF8427</b>		
<b>Tiguan 103 Turbo Diesel</b>		8/08-on	4 Cyl 2.0L CBAB
<i>Water Pump</i>	<b>TF8402</b>		
<i>Thermostat &amp; Housing</i>	<b>TTH593</b>		
<b>Touareg Turbo Diesel</b>		10/04-12/09	5 Cyl 2.5L BAC
<i>Water Pump</i>	<b>TF8318</b>		
<i>Thermostat &amp; Housing</i>	<b>TTH547</b>		
<b>Touareg</b>		9/03-on	V6 3.2L, 3.6L BMV, BHK
<i>Water Pump</i>	<b>TF8310</b>		
<b>Touareg</b>		9/03-9/06	V8 4.2L AXQ
<i>Water Pump</i>	<b>TF8412</b>		
<b>Transporter T5 Turbo Diesel</b>		1/04-on	4 Cyl 1.9L AXB, BRS
<i>Water Pump</i>	<b>TF8314</b>		



Description	Part No	Year & Notes	Engine
<b>VOLKSWAGEN</b>			
<b>Transporter T4</b>		1/93-9/04	4 Cyl 2.0L AAC
Water Pump	TF2453		
<b>Transporter T5</b>		8/04-on	4 Cyl 2.0L AXA
Water Pump	TF8131		
<b>Transporter T3</b>		1/88-1/92	4 Cyl 2.1L
Water Pump	TF8237		
<b>Transporter T4 Diesel</b>		12/94-9/04	5 Cyl 2.4L, 2.5L AAB, AVR
Water Pump	TF8134		
<b>Transporter T4, T5 Turbo Diesel</b>		1/94-1/08	5 Cyl 2.5L AXD, AXE
Water Pump	TF8318		
Thermostat & Housing	TTH547		
<b>Transporter T5 Turbo Diesel</b>		10/06-on	5 Cyl 2.5L BNZ, BPC
Water Pump	TF8318		
Thermostat & Housing	TTH547		
<b>Transporter T5</b>		9/04-7/08	V6 3.2L BKK, BUB
Water Pump	TF8310		
<b>Vento</b>		5/95-4/98	4 Cyl 2.0L ADY
Water Pump	TF2453		
<b>VOLVO</b>			
<b>240</b>		1/83-10/93	4 Cyl 2.1L, 2.3L B21A, B23E, B230F
Water Pump	TF969	<i>To 1984 B21 &amp; B23 Engine Code</i>	
Water Pump	TF1551	<i>From 1984 B230 Engine Code</i>	
<b>242, 244, 245</b>		3/75-12/82	4 Cyl 2.1L, 2.3L B21A, B21E, B23E
Water Pump	TF969		
<b>260, 264, 265</b>		1981-86	V6 2.8L B28E
Water Pump	TF1553		
<b>440</b>		10/93-9/96	4 Cyl 2.0L B20F
Water Pump	TF8236		
<b>740</b>		6/85-12/91	4 Cyl 2.3L
Water Pump	TF1551		

Description	Part No	Year & Notes	Engine
<b>VOLVO</b>			
<b>760</b>		<b>1/84-3/86</b>	<b>4 Cyl 2.3L B230ET</b>
Water Pump	<b>TF969</b>	<i>To 1/85 Check Identification Guide for correct Pump</i>	
Water Pump	<b>TF1551</b>	<i>From 1/85 check Identification Guide for correct Pump</i>	
<b>760</b>		<b>2/83-12/90</b>	<b>V6 2.8L B28F</b>
Water Pump	<b>TF1553</b>		
<b>850</b>		<b>10/92-1/97</b>	<b>5 Cyl 2.3L, 2.4L B5234T, B5244T</b>
Water Pump	<b>TF4674</b>	<i>To Engine No. 131034</i>	
Water Pump	<b>TF8353</b>	<i>From Engine No. 131035</i>	
<b>940</b>		<b>11/90-9/96</b>	<b>4 Cyl 2.3L B23F, B230, B234</b>
Water Pump	<b>TF1551</b>		
<b>960</b>		<b>11/90-10/91</b>	<b>V6 2.8L B280F</b>
Water Pump	<b>TF1553</b>		
<b>960</b>		<b>12/91-3/97</b>	<b>6 Cyl 2.9L B6304F</b>
Water Pump	<b>TF4674</b>	<i>To Engine No. 131034</i>	
Water Pump	<b>TF8353</b>	<i>From Engine No. 131035</i>	
<b>C30</b>		<b>3/07-on</b>	<b>5 Cyl 2.4L,2.5L B5254T, D5244T</b>
Water Pump	<b>TF8353</b>		
<b>C70</b>		<b>3/98-7/04</b>	<b>5 Cyl 2.3L, 2.4L B5234, B5244</b>
Water Pump	<b>TF4674</b>		
<b>C70</b>		<b>1/06-on</b>	<b>5 Cyl 2.5L B5254T3, B5254T</b>
Water Pump	<b>TF8353</b>		
<b>S40</b>		<b>10/97-2/04</b>	<b>4 / 6 Cyl 1.8L, 1.9L B4184, B4194, B4204</b>
Water Pump	<b>TF8353</b>		
<b>S40 MPFi Petrol</b>		<b>2/04-on</b>	<b>5 Cyl 2.4L B5244S</b>
Water Pump	<b>TF8353</b>		
<b>S40 Turbo Diesel</b>		<b>3/07-12/09</b>	<b>5 Cyl 2.4L B5244T</b>
Water Pump	<b>TF8353</b>		
Thermostat & Housing	<b>TTH530</b>		
<b>S40</b>		<b>2/04-on</b>	<b>5 Cyl 2.5L B5254T</b>
Water Pump	<b>TF8353</b>		

Description	Part No	Year & Notes	Engine
<b>VOLVO</b>			
<b>S60</b>		12/00-on	5 Cyl 2.3L, 2.4L B5234T, B5244S/T
<i>Water Pump</i>	<b>TF8353</b>		
<b>S60</b>		2/03-on	5 Cyl 2.5L B5254T
<i>Water Pump</i>	<b>TF8353</b>		
<i>Thermostat &amp; Housing</i>	<b>TTH519</b>		
<b>S70</b>		3/97-1/01	5 Cyl 2.3L, 2.4L B5234, B5252, B5254
<i>Water Pump</i>	<b>TF8353</b>		
<b>S80 Turbo Diesel</b>		10/06-on	5 Cyl 2.4L D5244T
<i>Water Pump</i>	<b>TF8379</b>		
<i>Thermostat &amp; Housing</i>	<b>TTH530</b>		
<b>S80 Twin Turbo</b>		5/98-1/06	6 Cyl 2.8L B6284T
<i>Water Pump</i>	<b>TF4674</b>		
<b>S90</b>		2/97-8/98	6 Cyl 2.9L B6304F
<i>Water Pump</i>	<b>TF4674</b>		
<b>V40</b>		10/97-2/05	4 Cyl 1.8L,1.9L B4184,B4194,B4204
<i>Water Pump</i>	<b>TF8353</b>		
<b>V50 MPFi Petrol</b>		2/04-on	5 Cyl 2.4L B5244S
<i>Water Pump</i>	<b>TF4674</b>		
<b>V50 Turbo Diesel</b>		3/07-on	5 Cyl 2.4L D5244T
<i>Water Pump</i>	<b>TF8379</b>		
<i>Thermostat &amp; Housing</i>	<b>TTH530</b>		
<b>V50</b>		2/04-on	5 Cyl 2.5L B5254T
<i>Water Pump</i>	<b>TF8353</b>		
<b>V70</b>		3/97-4/04	5 Cyl 2.3L, 2.4L B5234T, B5244T
<i>Water Pump</i>	<b>TF8353</b>		
<i>Thermostat &amp; Housing</i>	<b>TTH540</b>		
<b>V70</b>		3/97-4/05	5 Cyl 2.4L B5252F
<i>Water Pump</i>	<b>TF8353</b>		
<b>V70</b>		3/97-1/06	5 Cyl 2.5L B5254T
<i>Water Pump</i>	<b>TF8353</b>		

Description	Part No	Year & Notes	Engine
<b>VOLVO</b>			
<b>V90</b>		<b>3/97-2/99</b>	<b>6 Cyl 2.9L B6304</b>
<i>Water Pump</i>	<b>TF4674</b>		
<b>XC70 MPFi Petrol</b>		<b>9/00-2/03</b>	<b>5 Cyl 2.4L B5244T3</b>
<i>Water Pump</i>	<b>TF8353</b>		
<i>Thermostat &amp; Housing</i>	<b>TTH540</b>	<i>To Engine No. 3264757</i>	
<b>XC70 Turbo Diesel</b>		<b>1/08-on</b>	<b>5 Cyl 2.4L D5244T</b>
<i>Water Pump</i>	<b>TF8379</b>		
<i>Thermostat &amp; Housing</i>	<b>TTH530</b>		
<b>XC70 Turbo Diesel</b>		<b>2/03-1/08</b>	<b>5 Cyl 2.5L B5254T</b>
<i>Water Pump</i>	<b>TF8353</b>		
<i>Thermostat &amp; Housing</i>	<b>TTH519</b>		
<b>XC90 Turbo Diesel</b>		<b>10/06-on</b>	<b>5 Cyl 2.4L D5244T</b>
<i>Water Pump</i>	<b>TF8379</b>		
<i>Thermostat &amp; Housing</i>	<b>TTH530</b>		
<b>XC90 Turbo Petrol</b>		<b>7/03-3/08</b>	<b>5 Cyl 2.5L B5254T</b>
<i>Water Pump</i>	<b>TF8353</b>		
<i>Thermostat &amp; Housing</i>	<b>TTH540</b>	<i>From Eng. 3264758</i>	
<b>XC90 Turbo Petrol</b>		<b>7/03-10/06</b>	<b>6 Cyl 2.9L B6294T</b>
<i>Water Pump</i>	<b>TF8379</b>		





TF181

Ford



TF216

Landrover



TF220

Holden



TF564

Ford



TF578

Chrysler



TF587

Holden

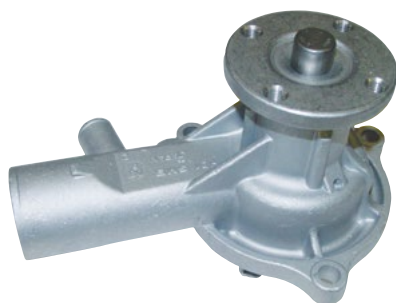

TF726

Holden



TF730

Ford



TF731

Toyota



TF738

MG



TF746

Ford



TF752

Nissan



TF754

Nissan



TF756

Ford

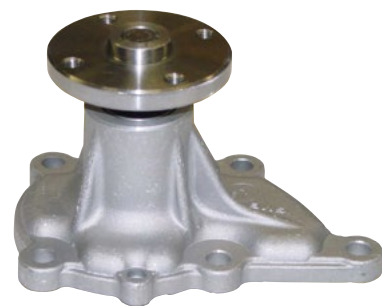

TF788

Nissan





TF798

Toyota



TF800

Ford



TF802

Chrysler



TF803/8

Holden



TF804

Ford



TF805

Ford

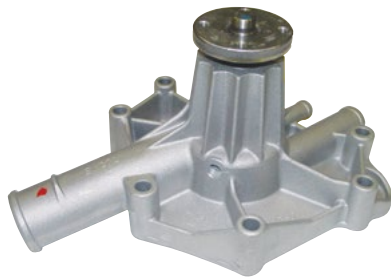

TF806

Chrysler



TF807

Ford



TF809

Ford



TF809C

Ford



TF811

International



TF812

Holden

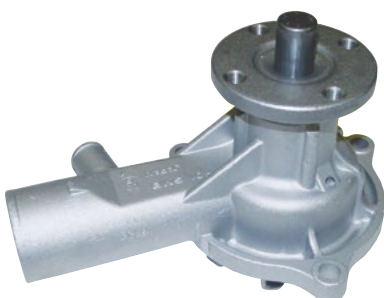

TF814

Holden

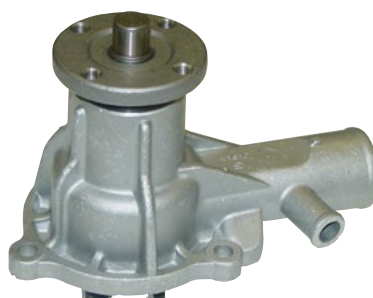

TF815

Holden



TF816

Toyota



TF817

Ford



TF819

Toyota



TF822

Chrysler

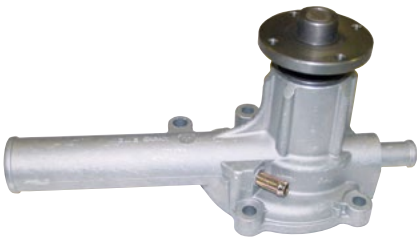

TF824

Ford



TF827

Holden



TF833

Nissan



TF835

Toyota



TF836A

Toyota



TF837

Nissan

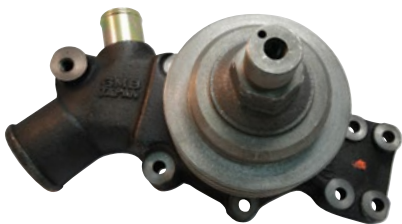

TF840

Jaguar



TF841

Toyota

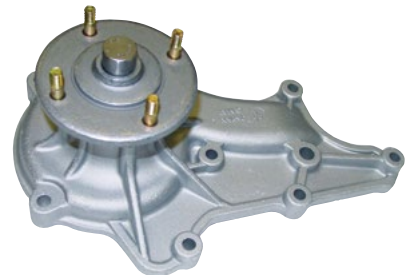

TF842

Toyota



TF843

Honda

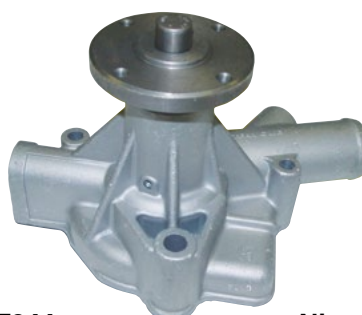

TF844

Nissan



TF846

Nissan





TF847

Daihatsu



TF848

Subaru



TF851

Mazda

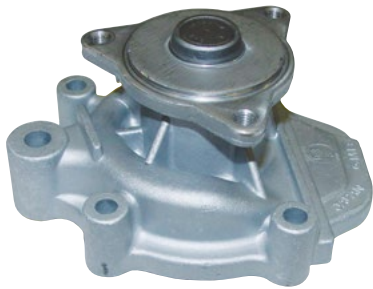

TF855

Honda



TF856

Toyota



TF857

Nissan



TF858

Daihatsu

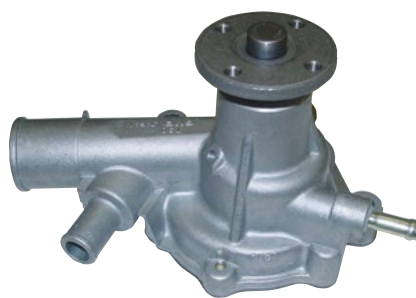

TF859

Toyota



TF864

Holden



TF877

Hyundai



TF878

Mitsubishi



TF880

Jaguar



TF885

Daihatsu

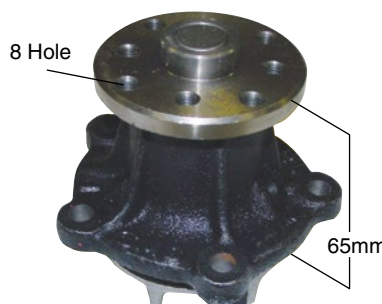

TF887

Toyota



TF888

Holden

Round Teeth



TF893

Ford



TF894

Daihatsu

Square Teeth



TF895

Ford

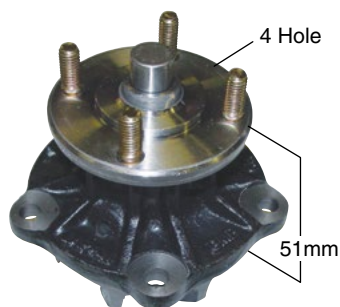

TF896

Toyota



TF897

Toyota

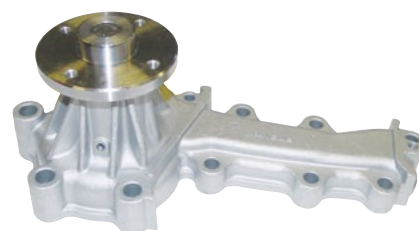

TF898

Holden



TF907

Honda



TF913

Nissan



TF935

Bedford



TF959

Daihatsu



TF969

Volvo



TF972

Lada



TF995

Mercedes



TF1000

Holden

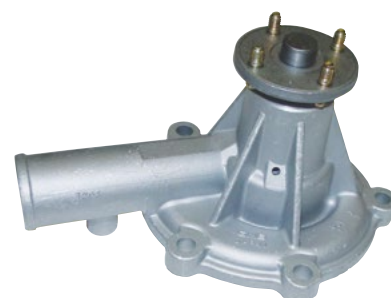

TF1009

Ford





TF1014

Chrysler



TF1018

Asia



TF1020

Ford



TF1022

Holden

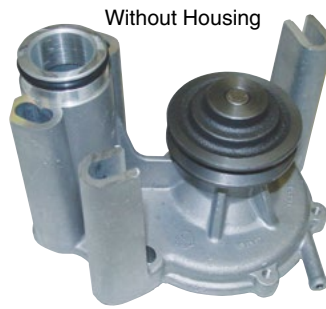

Without Housing

TF1025

Mitsubishi



With Housing

TF1025BP

Mitsubishi

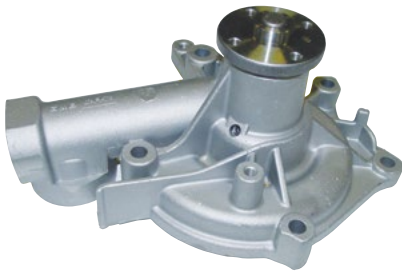

TF1027

Hyundai



TF1028

Ford



TF1032

Mitsubishi



TF1039

Holden



TF1040

Ford



TF1053

Toyota



TF1055

Toyota

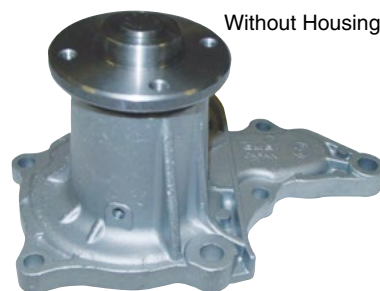

Without Housing

TF1058

Toyota

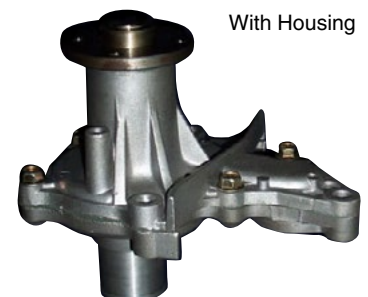

With Housing

TF1058H

Toyota





TF1061

Toyota



TF1063

Toyota

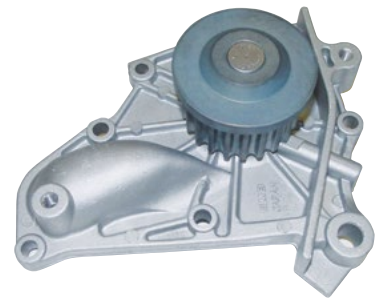

TF1090

Toyota



TF1100

Holden



TF1120

Honda



TF1130

Honda



TF1132

Honda



TF1150

Mazda



TF1160

Mitsubishi



TF1170

Nissan

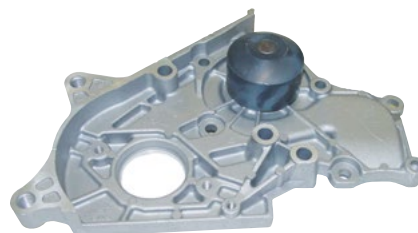

TF1200

Toyota



TF1210

Toyota



TF1220

Toyota

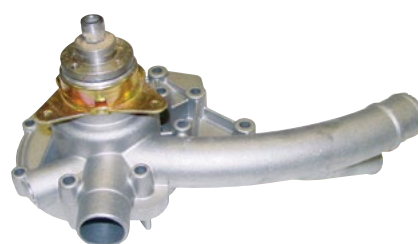

TF1408

Mercedes



TF1551

Volvo

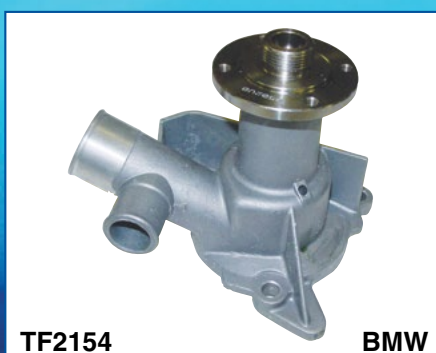
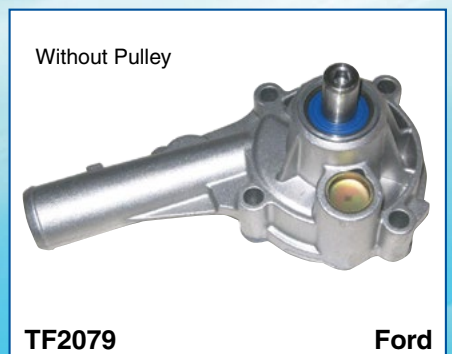
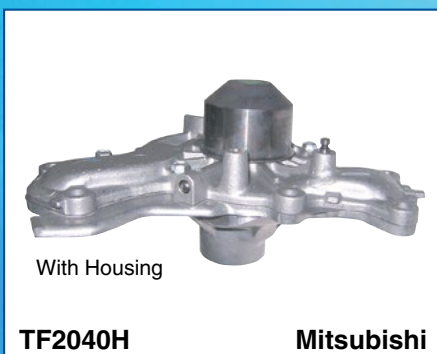
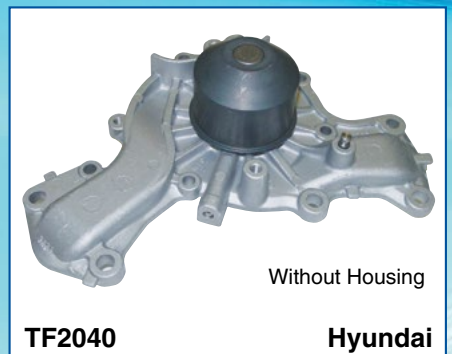
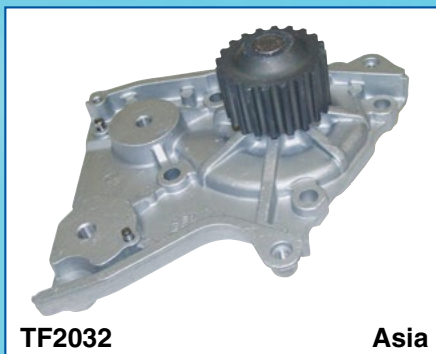
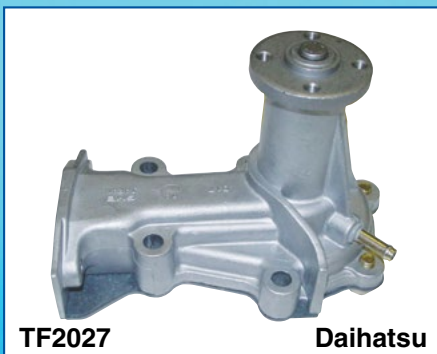
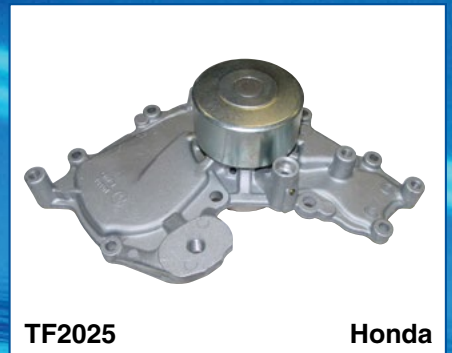
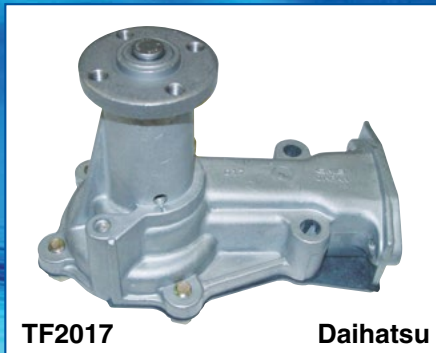
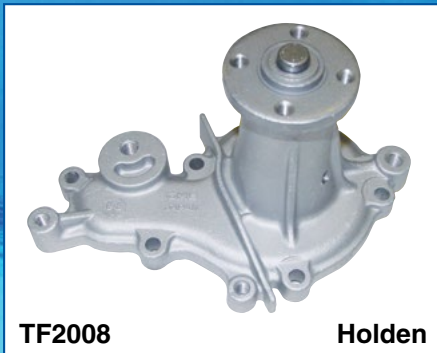
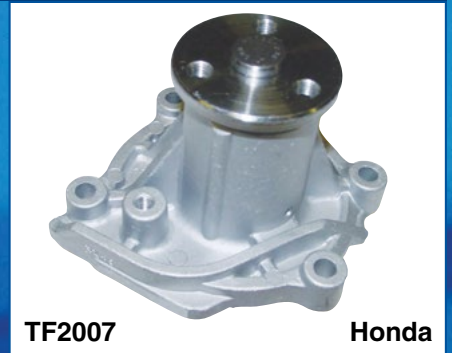





TF2191

Nissan



TF2354

Mercedes

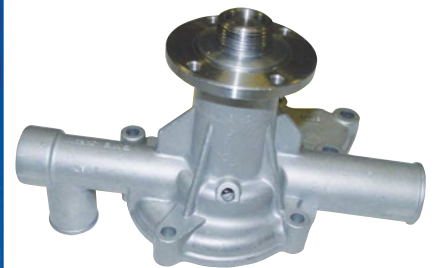

TF2358

BMW

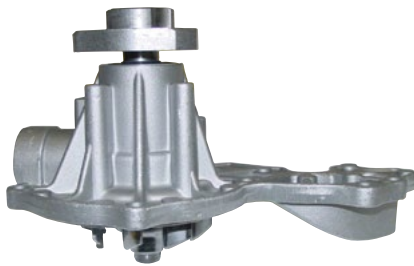

TF2453

Audi

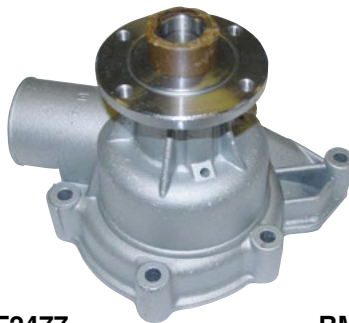

TF2477

BMW

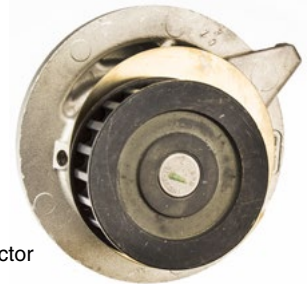

With  
Dust  
Deflector

TF2512

Daewoo



TF2565

Ford



TF2593

Holden



TF2614

Landrover



TF2646

BMW

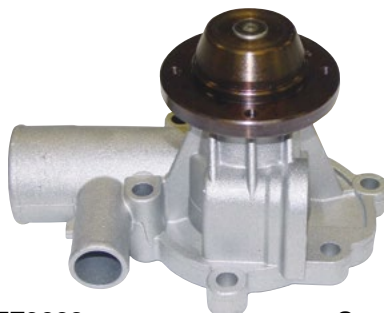

TF2663

Saab



TF2671

BMW



TF2735

BMW



TF2799

Mitsubishi



24 Teeth

TF2800

Daewoo



TF2953

Ford



TF2962

Saab

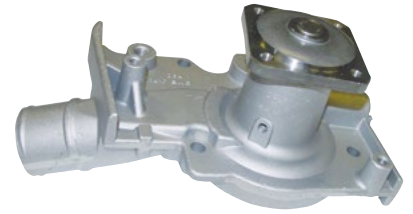

TF2990

Ford

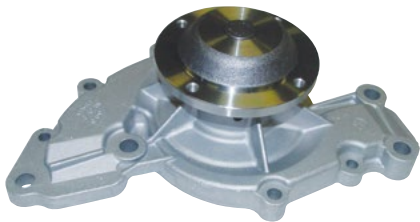

TF3000

Holden



TF3003

Isuzu



TF3004

Isuzu

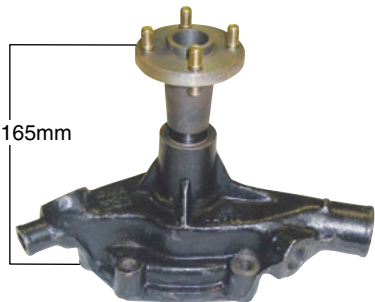

TF3008

Daihatsu



TF3009

Daihatsu

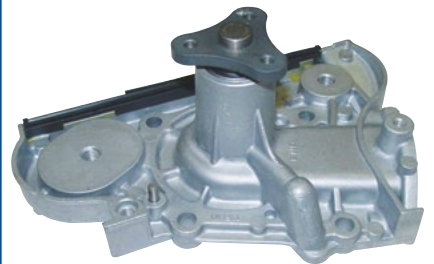

TF3010

Ford



TF3012

Suzuki



TF3013

Ford



TF3014

Asia

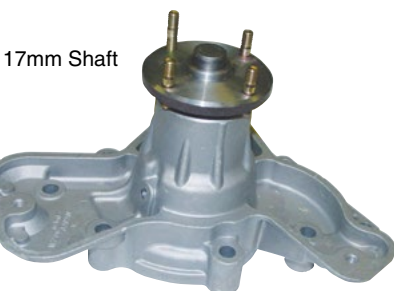

TF3015

Mazda



TF3016

Honda



TF3018

Honda





TF3019

Honda

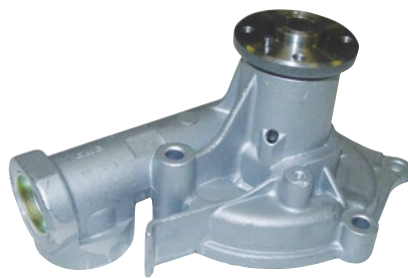

TF3020

Hyundai



TF3022

Ford

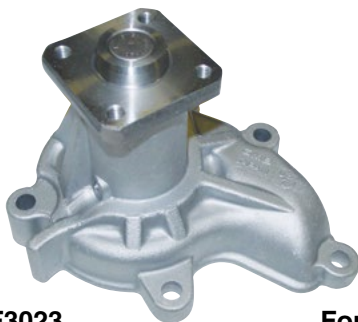

TF3023

Ford



TF3024

Nissan



TF3025

Nissan



TF3026

Nissan

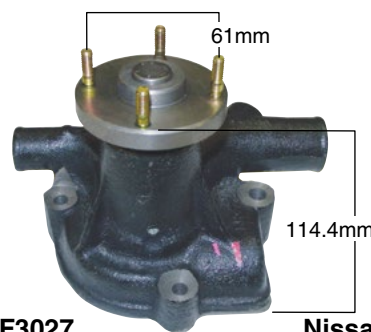

TF3027

Nissan



TF3028

Nissan



TF3030

Nissan



TF3032

Mazda



TF3033

Subaru



TF3035

Subaru



TF3036

Suzuki

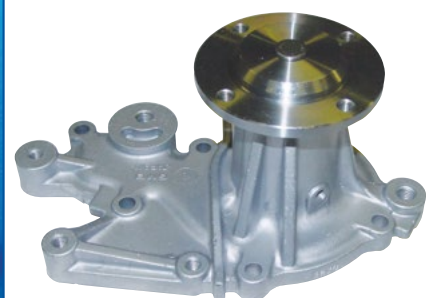

TF3037

Holden





TF3038

Daihatsu



TF3039

Holden

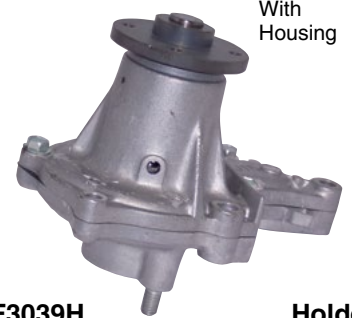

TF3039H

Holden

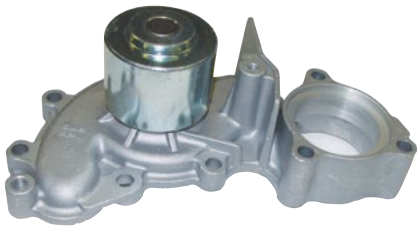

TF3040

Holden

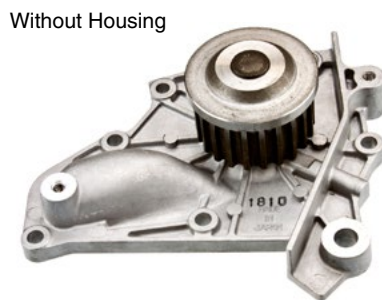

TF3041

Toyota

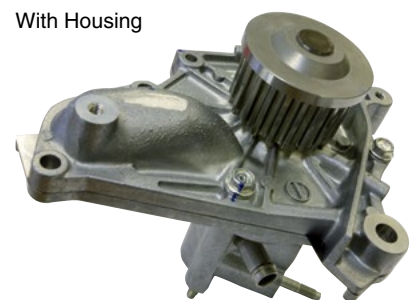

TF3041H

Toyota



TF3042

Toyota

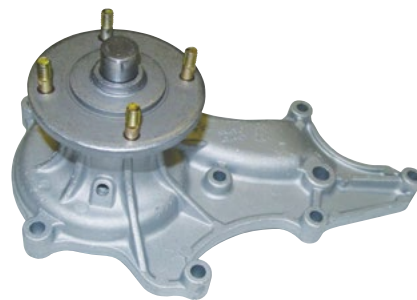

TF3045

Toyota



TF3046

Toyota

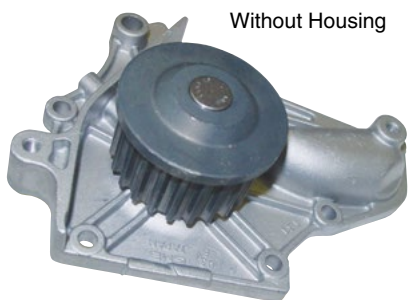

TF3047

Holden

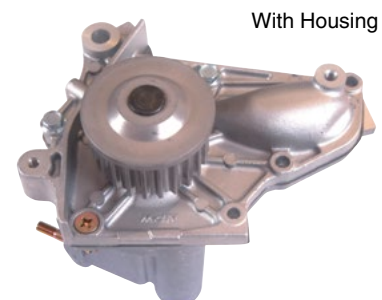

TF3047H

Holden



TF3049

Toyota



TF3050

Nissan



TF3051

Toyota



TF3052

Toyota



TF3053

Nissan



TF3055

Toyota



TF3058

Nissan

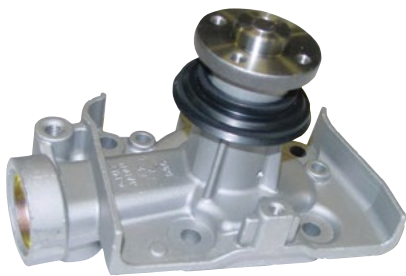

TF3059

Daihatsu



TF3060

Hyundai



TF3061

Mitsubishi



TF3063

Honda



TF3067

Subaru

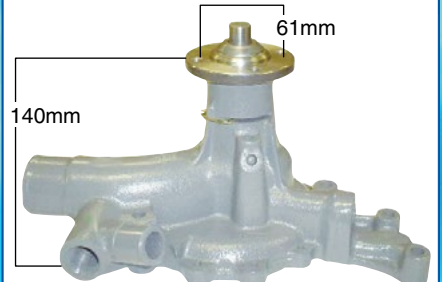

TF3068

Toyota

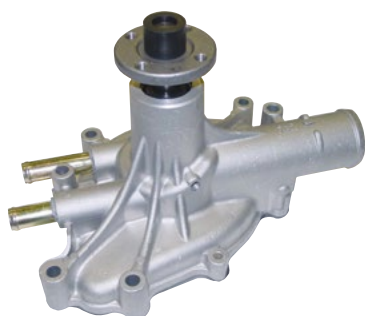

TF3069

Ford



TF3070

Ford



TF3071

Daewoo



TF3072

Holden



TF3074

Daewoo



TF3075

Eunos



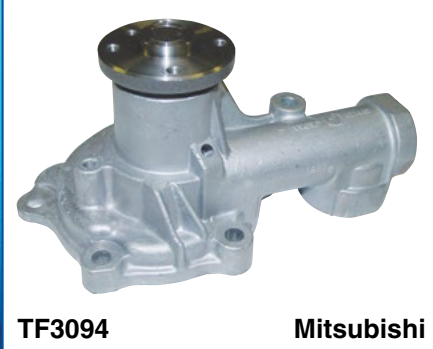
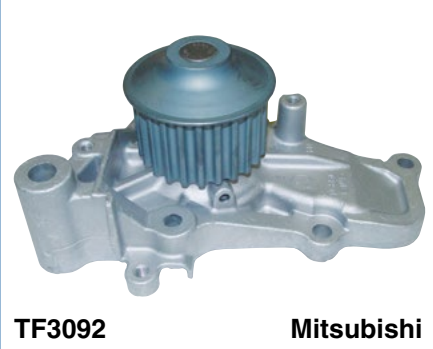
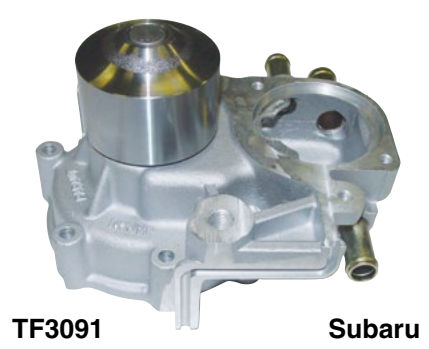
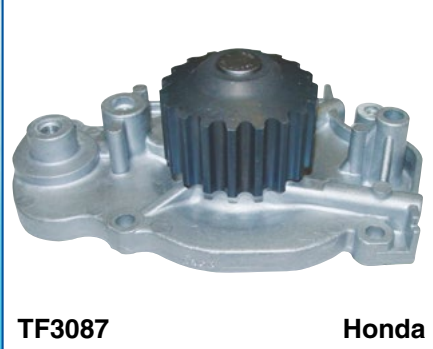
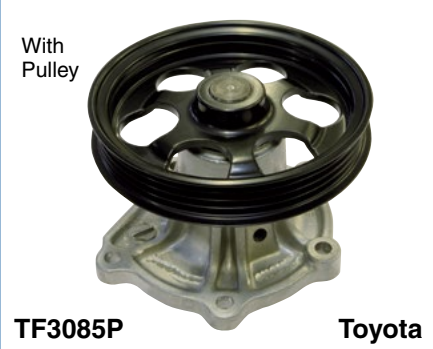
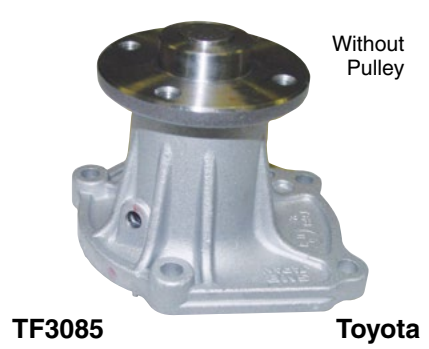
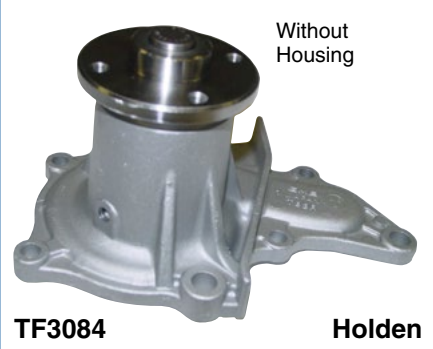
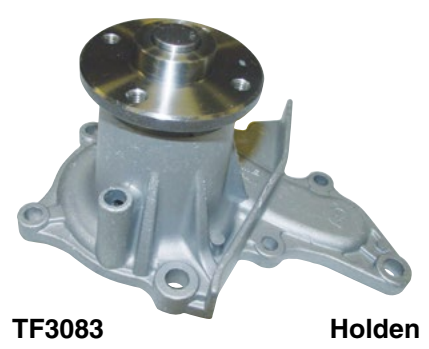
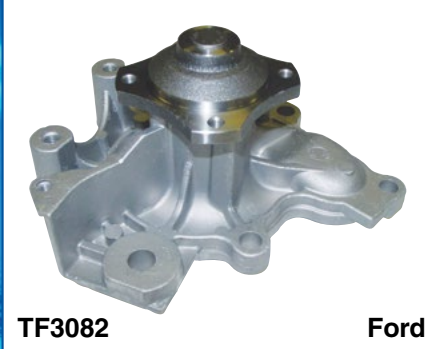
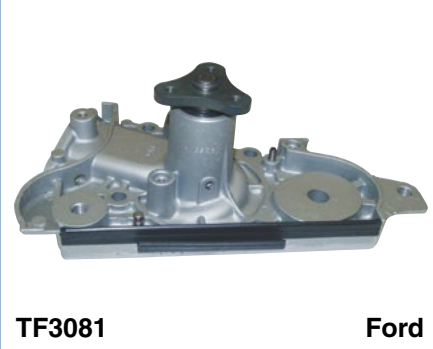
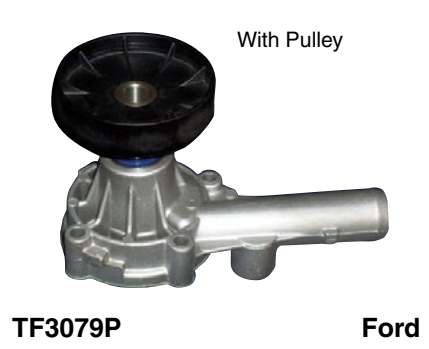
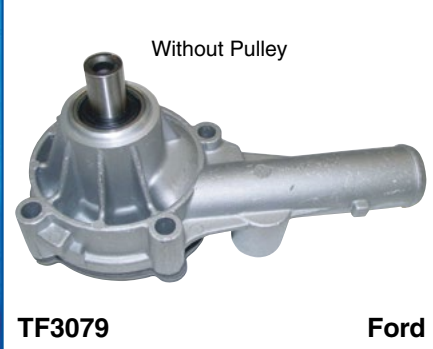
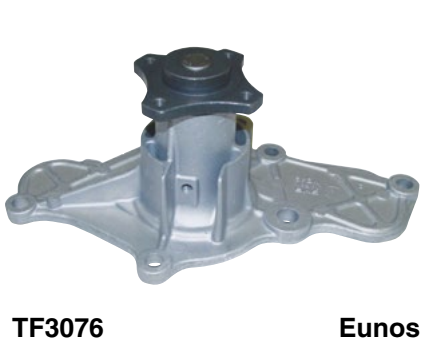



TF3097

Nissan



TF3098

Nissan



TF3099

Nissan

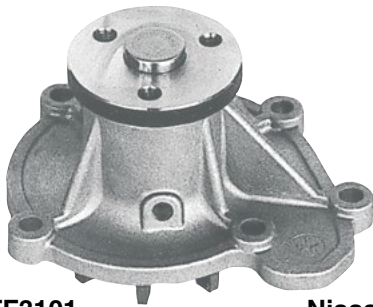

TF3101

Nissan



TF3104

Lexus

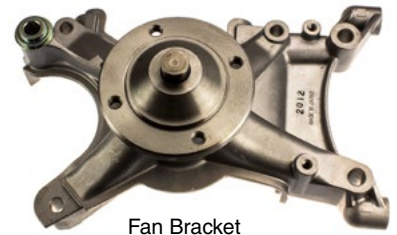

Fan Bracket

TF3104FB

Lexus



TF3105

Toyota



TF3106

Toyota



TF3111

Daihatsu



TF3112

Holden



With Housing

TF3114

Hyundai



TF3115

Mitsubishi

Also Check  
TF8274

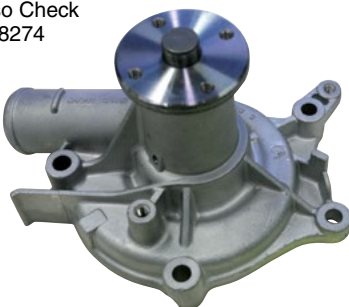

TF3117

Mitsubishi



TF3118

Nissan



TF3119

Nissan



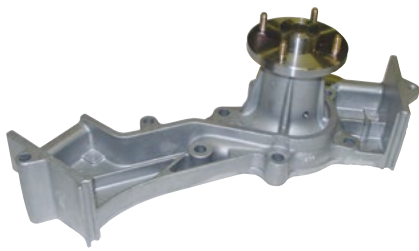

TF3120

Nissan

Also Check  
TF3009



TF3122

Daihatsu



TF3123

Ford



TF3130

BMW



TF3131

Toyota



TF3132

Toyota



TF3133

Jeep



TF3138

Nissan

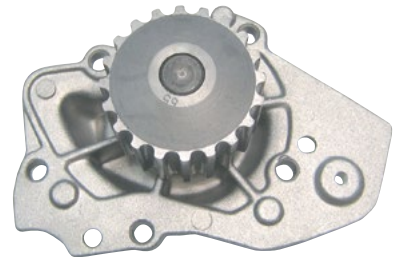

TF3141

Citroen



TF3144

Mitsubishi

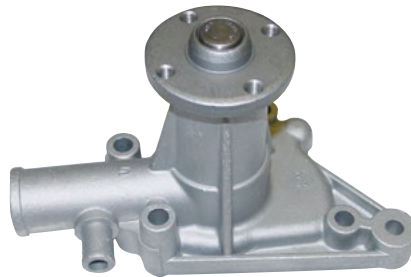

TF3709

Mini

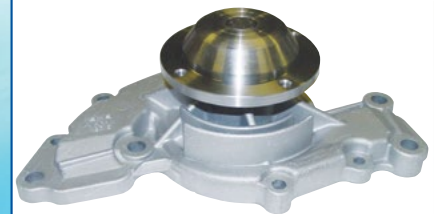

TF4000

Holden

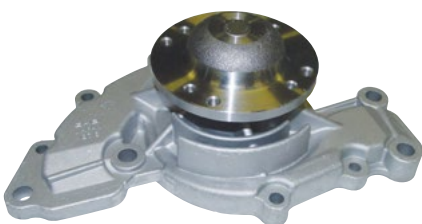

TF4001

Holden

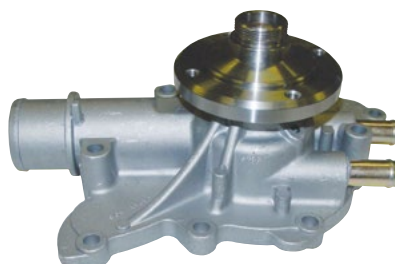

TF4002

Ford



TF4003

Honda





TF4005

Toyota



TF4006

Toyota

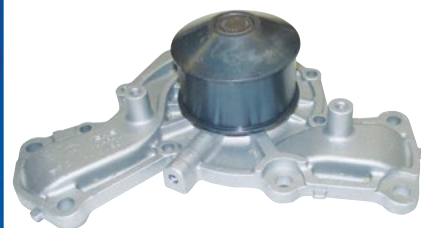

TF4007

Without Housing

Mitsubishi

With Housing



TF4007H

Mitsubishi



TF4008

Mitsubishi

Also Check  
TF8274



TF4009

Toyota



TF4010

Toyota



TF4011

Nissan



TF4012

Mitsubishi

Without Thermostat Housing



TF4013

Holden

With Thermostat Housing



TF4013H

Holden

Without Housing



TF4014

Mitsubishi

With Housing



TF4014H

Mitsubishi



TF4015

Holden



TF4016

Mazda

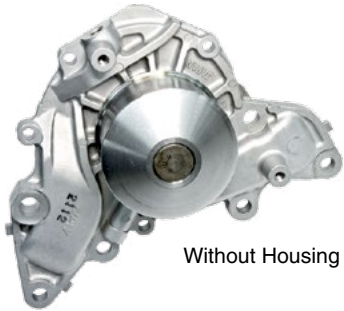

Without Housing

TF4018

Mitsubishi



With Housing

TF4018H

Mitsubishi



TF4021

Nissan

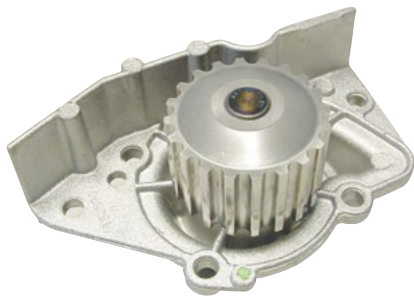

TF4028

Citroen



TF4035

Mercedes



TF4040

Hyundai



TF4042

Holden



TF4043

Hyundai



TF4045

Daewoo

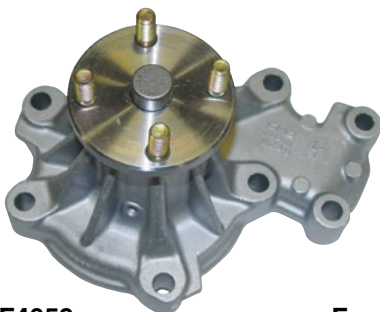

TF4059

Ford



TF4064

Nissan



TF4065

Mitsubishi

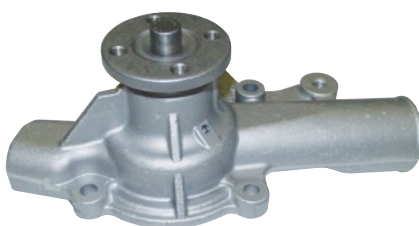

TF4100

Jeep

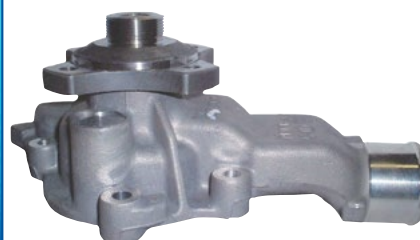

TF4101

Jeep



TF4102

Chrysler



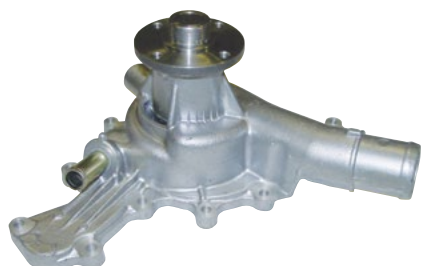

TF4103

Ford



TF4104

Hyundai



TF4105

Hyundai



TF4108

Mitsubishi



TF4113

Holden



TF4130

Nissan



TF4498

Ford



TF4674

Volvo



TF4762

Audi

With Housing

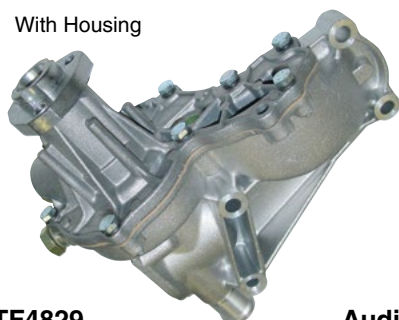

TF4829

Audi



TF5000

Holden



TF5003

Toyota



TF5010

Ford

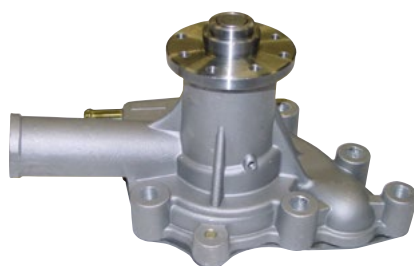

TF5013

Holden

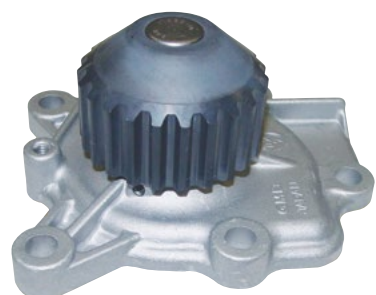

TF5019

Holden



TF5023

Holden



TF5028

Daihatsu



TF6056

Ford

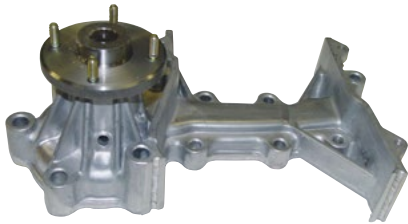

TF6071

Nissan



TF6090

Nissan



TF6380

Holden



TF7011

Toyota



TF7095

Kia

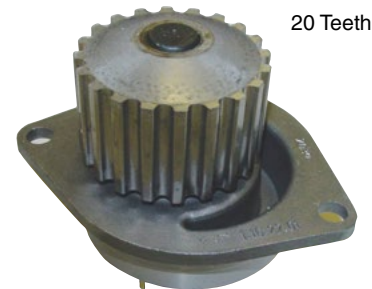

TF8100

Citroen



TF8101

Citroen

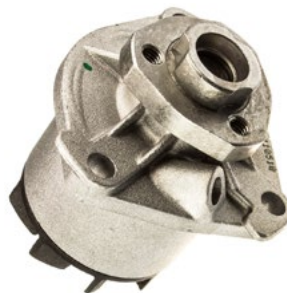

TF8103

Volkswagen



TF8104

Chrysler



TF8106

Holden



TF8107

Holden



TF8108

Holden





TF8109

Dodge



TF8110

Alfa Romeo



TF8111

Holden



24 Teeth

TF8112

Daewoo



TF8113

Daewoo



TF8114

Mercedes



TF8118

Mercedes



TF8119

Mercedes



TF8121

Mercedes



TF8123

Holden



TF8126

Audi



TF8128

Seat



TF8130

Volkswagen



TF8131

Audi



TF8132

Audi





TF8133 Volkswagen



TF8134 Volkswagen



TF8135 Audi



TF8136 Citroen



TF8137 Citroen



TF8138 Citroen

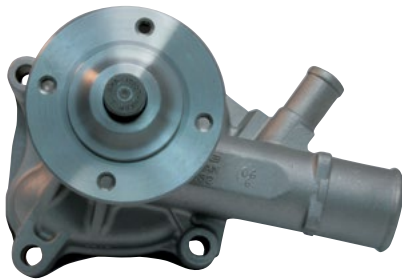

TF8139 Toyota

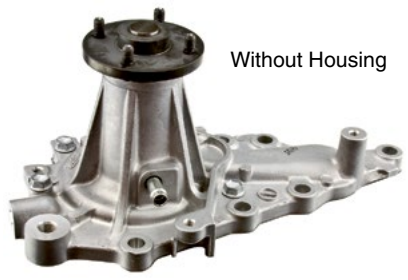

TF8141 Lexus



TF8141H Lexus



TF8142 Toyota



TF8143 Lexus



TF8143FB Lexus



TF8144 Daihatsu



TF8144H Daihatsu



TF8146 Fiat



TF8147

Toyota



TF8148

Lexus

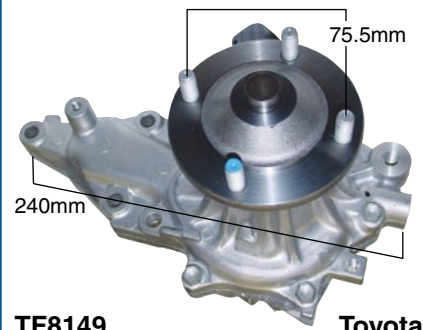

TF8149

Toyota

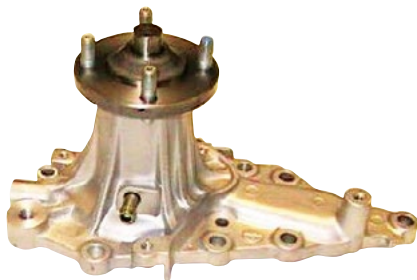

TF8150

Toyota



TF8151

Suzuki



TF8153

Suzuki



TF8154

Suzuki



TF8155

Honda

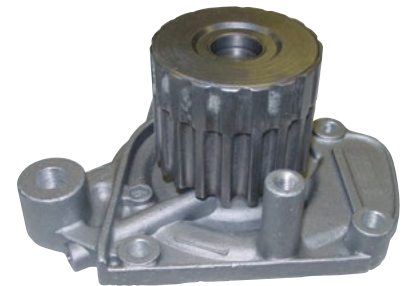

TF8156

Honda

22 Teeth



TF8157

Honda



TF8158

Honda



TF8159

Honda



TF8161

Honda



TF8162

Honda



TF8164

Honda





TF8165

Honda



TF8167

Nissan



TF8168

Nissan



TF8169

Nissan



TF8171

Hyundai



TF8172

Alfa Romeo



TF8174

Kia

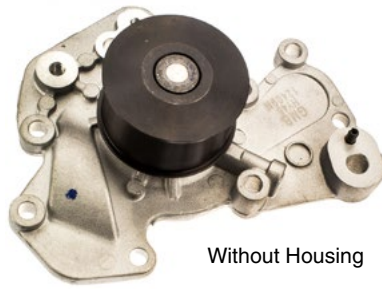

TF8175

Hyundai

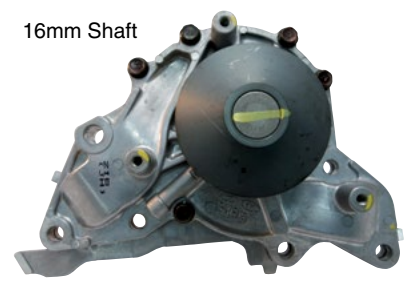

TF8176

Hyundai



TF8176H

Hyundai



TF8177

Mazda



TF8178

Mazda



TF8179

Ford



TF8181

Ford



TF8182

Landrover

Steel  
Impellor

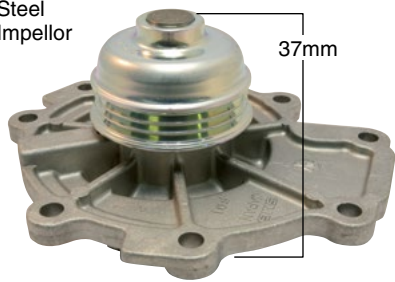

TF8183

Ford



TF8184

Ford



TF8185

Ford



TF8186

Ford



TF8187

Mitsubishi



TF8188

Mitsubishi



TF8189

Mitsubishi



TF8190

Mitsubishi



TF8191

Mitsubishi

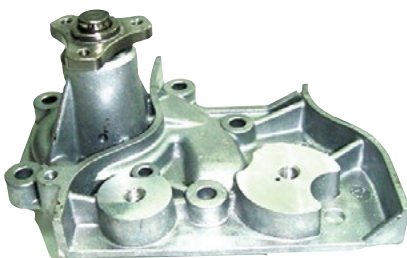

TF8192

Kia

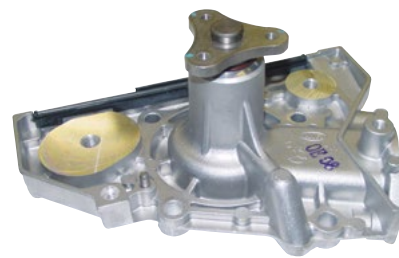

TF8193

Kia



TF8194

Kia



TF8195

Kia



TF8196

Kia



TF8197

Chrysler





TF8198

Landrover

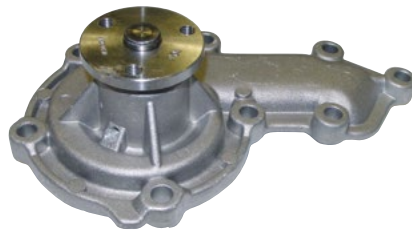

TF8199

Landrover



TF8200

Mercedes



TF8203

Ford



TF8206

Daihatsu

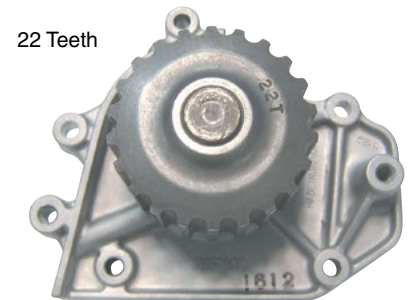

TF8207

Honda

22 Teeth



TF8208

Ford



TF8209

Toyota



TF8210

Jeep



TF8211

Daihatsu

Without Housing



TF8211H

Daihatsu



TF8213

Toyota

With Pulley and Housing



TF8221

Nissan



TF8223

Nissan



TF8227

Toyota



TF8228

Lotus



TF8229

Lexus



Left Hand Side  
Chamber Hole  
Also Check  
TF8370

TF8230

Landrover

20 Teeth

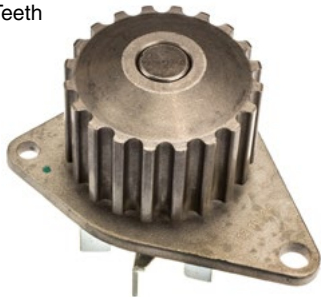

TF8235

Citroen



TF8236

Renault



TF8237

Volkswagen



TF8238

Mercedes



TF8239

Audi

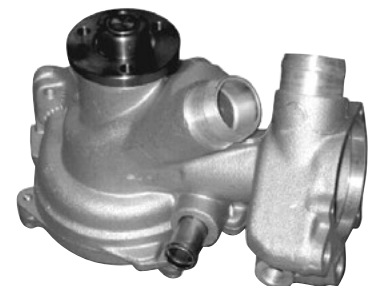

TF8241

Daewoo



TF8248

Renault



TF8250

Alfa Romeo



TF8251

Audi



TF8252

BMW



TF8253

Lexus

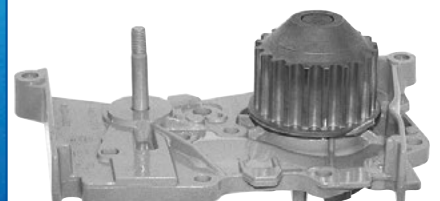

TF8254

Renault





TF8256

Landrover

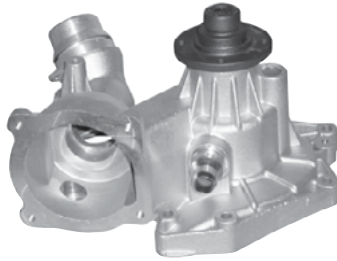

TF8258

BMW

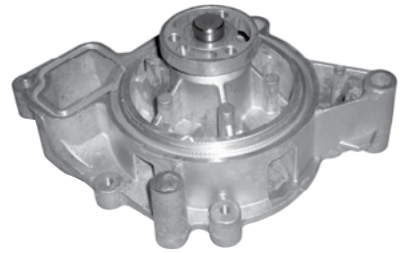

TF8259

Alfa Romeo



TF8260

Mini

3-Bolt Hub



TF8261

Daihatsu



TF8262

Mazda



TF8263

Holden

Without Housing



TF8264

Ford

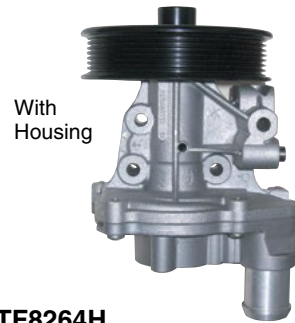

TF8264H

Ford

With Housing



TF8265

Ford



TF8266

Holden



TF8267

Nissan



TF8268

Subaru

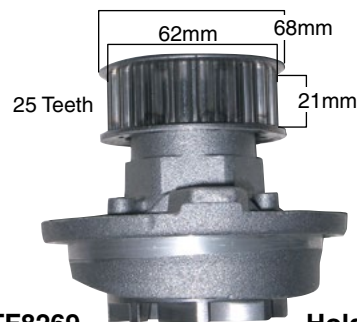

TF8269

Holden



TF8270

Suzuki



TF8271

Landrover

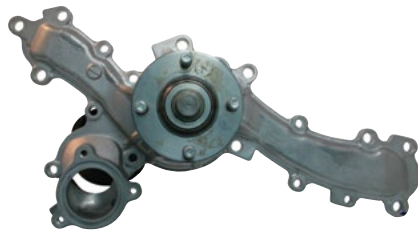

TF8272

Toyota



With Welch Plug

TF8273

Daewoo

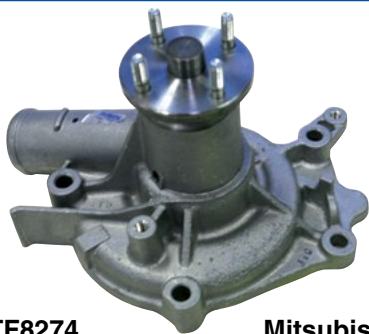

TF8274

Mitsubishi

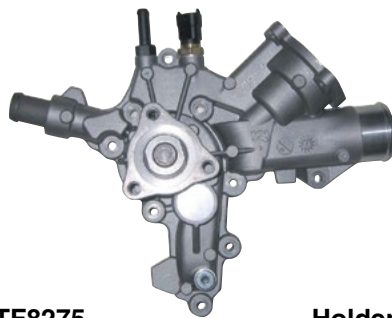

TF8275

Holden

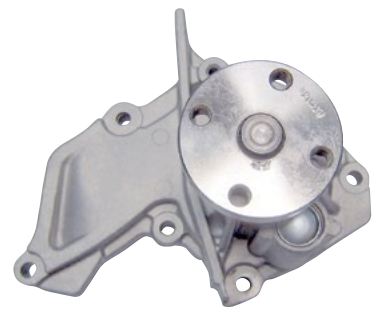

TF8277

Ford



TF8278

Holden



TF8281

Toyota



17mm shaft  
8mm high

TF8282

Mazda



TF8284

Toyota



TF8286

BMW



TF8287

BMW



TF8290

Rover



TF8293

Chrysler



TF8295

Toyota





TF8299

Daihatsu



TF8301

Ssangyong

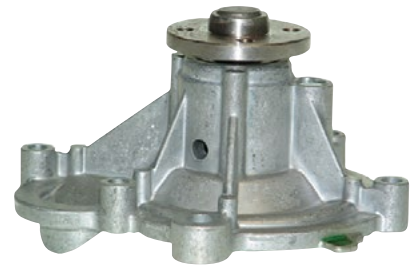

TF8302

Mercedes



TF8303

Mercedes



TF8304

Mercedes



TF8305

Ssangyong



TF8306

Ssangyong



TF8307

Renault



TF8308

Holden



TF8310

Audi



TF8314

Volkswagen



TF8316

Audi



TF8317

Audi



TF8318

Volkswagen



TF8320

Audi



TF8321

Audi

Plastic Impellor  
Without Housing



TF8323

Ford

30mm outlet

Plastic Impellor  
with Housing



TF8323H

Ford



TF8324

Mercedes



TF8325

BMW



TF8328

Citroen



TF8329

Citroen



TF8330

Citroen



TF8332

Mitsubishi



TF8333

Mitsubishi



TF8334

Mitsubishi



TF8335

Mitsubishi

With Housing



TF8336

Ssangyong



TF8338

Honda



TF8339

Honda





TF8340

Honda



TF8341

Honda



TF8342

Ford



TF8343

Nissan

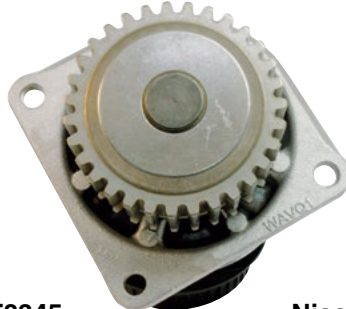

TF8345

Nissan



TF8346

Nissan



TF8347

Daihatsu



TF8348

Hyundai

Without Housing



TF8348H

Hyundai

With Housing



TF8350

Hyundai



TF8352

Hyundai



TF8353

Ford



TF8354

Jeep



TF8355

Chrysler



TF8357

Jeep



TF8358

Alfa Romeo



TF8359

Mercedes



TF8360

Mercedes



TF8361

Renault



TF8363

Mitsubishi



TF8364

Mitsubishi



TF8365

Mitsubishi



Without Housing

TF8366

Jeep



With Housing

TF8366H

Jeep



TF8367

Mazda



TF8368

Kia

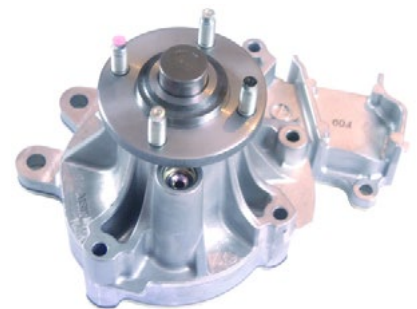

TF8369

Toyota



RH Side Chamber Hole

TF8370

Also Check TF8230

Landrover



TF8371

Nissan



TF8372

Nissan





TF8373

Toyota



TF8374

Holden



TF8375

Ford



TF8376

Mazda



TF8377

Fiat



TF8379

Volvo



TF8380

BMW



TF8381

BMW



TF8382

Citroen

20 Teeth



TF8383

Peugeot



TF8385

Audi



TF8386

Ford



TF8388

BMW



TF8390

Nissan



TF8391

Holden



TF8392

Hyundai



TF8393

Hyundai



TF8394

Ford



TF8395

Chrysler



TF8396

Jeep



TF8397

BMW



TF8398

Landrover



TF8399

Mercedes



TF8400

Chrysler



TF8401

Citroen



TF8402

Audi



TF8403

Hyundai



TF8404

Alfa Romeo



TF8405

Holden



TF8406

Holden





TF8407

Proton



TF8408

Proton



TF8409

Ford



TF8410

Landover



TF8411

Mercedes



TF8412

Audi



TF8413

Mitsubishi



TF8415

BMW



TF8416

BMW



TF8417

Citroen



TF8418

Volkswagen



TF8421

Alfa Romeo



TF8422

Mercedes



TF8423

Mercedes



TF8426

Fiat





TF8427

Volkswagen



TF8428

Mini



TF8429

Citroen



TF8430

Citroen



TF8432

Mini



TF8433

Lexus



TF8434

Ford



TF8435

Jeep

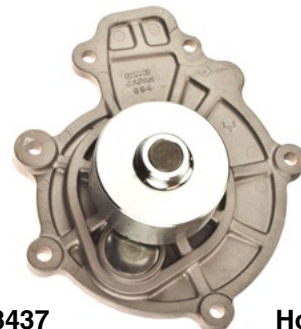

TF8437

Holden



TF8438

Hyundai



TF8439

Hyundai



TF8440

Toyota



TF8441

Kia



TF8442

Honda



TF8444

Hyundai





TF8444H

Hyundai



TF8445

Hyundai



TF8445H

Hyundai



TF8446

Lexus



TF8447

Suzuki



TF8448

Suzuki



TF8449

Honda



TF8450

Honda



TF8451

Toyota



TF8452

Nissan



TF8453

Toyota



TF8454

Holden



TF8455

Volkswagen



TF8456

Audi



TF8457

BMW





TF8458

Hyundai



TF8459

Holden



TF8460

BMW



TF8461

Smart



TF8462

BMW



TF8463

Mercedes



TF8465

Great Wall



TF8466

Great Wall



TF8467

Chery



TF8468

Chery



TF8469

Toyota



TF9000

Holden



TF9075

Daihatsu



TF9092

Lexus





TFC101

Ford



TFC102

Holden



TFC104

BMW



TFC105

Mitsubishi



TFC106

Toyota



TFC107

Toyota



TFC110

Ford



TFC111

Ford



TFC112

Toyota



TFC113

Holden



TFC114

Ford



TFC115

Nissan



TFC116

Daihatsu



TFC117

Ford



TFC119

Holden



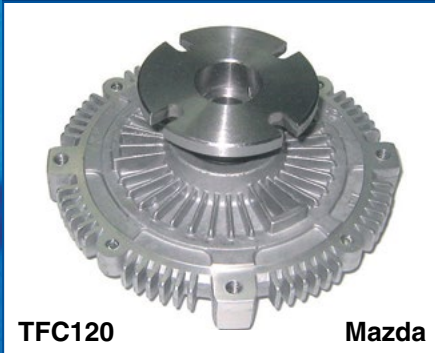





TFC139

Nissan



TFC141

Ford



TFC142

Toyota



TFC143

Toyota



TFC144

Toyota



TFC145

Suzuki



TFC146

Toyota



TFC150

Mitsubishi



TFC151

Toyota



TFC153

Mitsubishi



TFC154

Ford



TFC156

Toyota



TFC158

Ford



TFC159

Ford



TFC162

Ford





TFC163

Ford



TFC164

Nissan



TFC165

Nissan



TFC166

Nissan



TFC167

Nissan



TFC168

Suzuki



TFC169

Toyota



TFC170

Daihatsu



TFC175

Holden



TFC176

Toyota



TFC177

Jeep



TFC178

Ford



TFC179

Toyota



TFC180

Toyota



TFC183

Hyundai





TFC184

Toyota



TFC185

Toyota



TFC186

Toyota



TFC187

Suzuki



TFC188

Nissan



TFC189

Nissan



TFC190

Mitsubishi

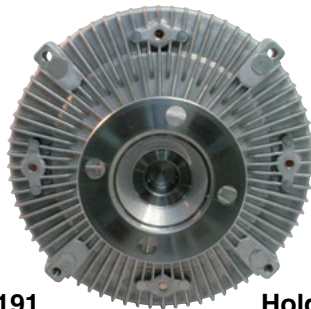

TFC191

Holden



TFC192

Toyota



TFC193

Ford



TFC194

Mazda



TFC198

Ford

Complete Assembly



TFC200

Kia



TFC202

Mitsubishi



TFC203

Mitsubishi





TFC205

Kia



TFC206

Daihatsu



TFC207

Holden



TFC208

Holden



TFC210

Mitsubishi



TFC211

Mitsubishi



TFC212

Mitsubishi



TFC214

Nissan



TFC215

Nissan



TFC216

Toyota



TFC217

Ford



TFC218

Toyota



TFC219

Toyota



TFC220

Toyota



TFC221

Toyota





TFC222

Holden



TFC224

Jeep



TFC225

Toyota



TFC226

Toyota



TFC227

Toyota



TFC228

Mitsubishi



TFC229

Mitsubishi

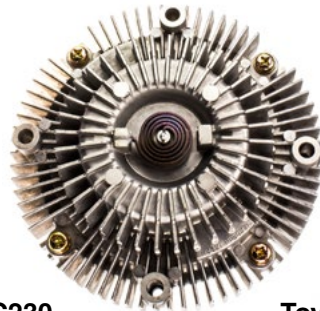

TFC230

Toyota

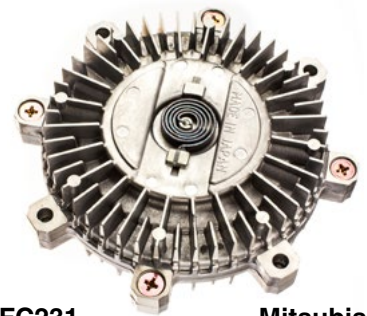

TFC231

Mitsubishi



TFC232

Toyota



TFC233

Holden



TFC234

Ford



TFC236

Lexus



TFC237

Nissan



# Radiator Fans

# TRU-FLOW

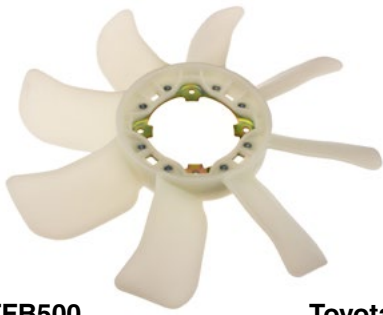

TFB500

Toyota

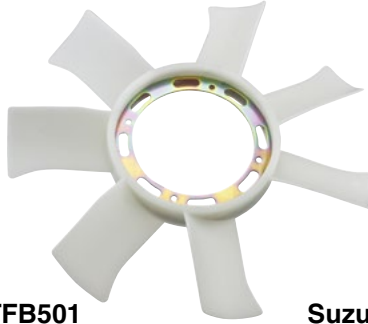

TFB501

Suzuki

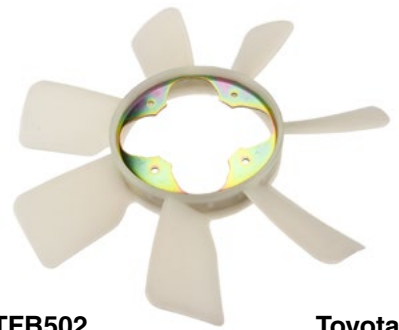

TFB502

Toyota



TFB503

Toyota



TFB504

Toyota



TFB505

Toyota



TFB506

Lexus



TFB507

Toyota



TFB508

Toyota

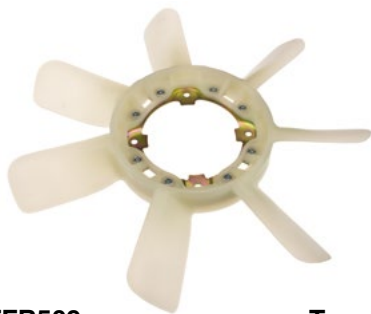

TFB509

Toyota



TFB510

Toyota



TFB511

Toyota



TFB512

Toyota



TFB513

Toyota



TFB514

Toyota

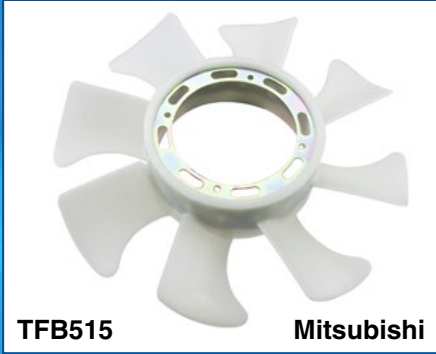



TFB530

Toyota



TFB531

Holden



TFB532

Toyota



TFB534

Toyota



TFB535

Toyota



TFB537

Toyota



TFB538

Ford



TFB539

Toyota





TTH500

Alfa Romeo



TTH501

Holden



TTH502

Holden



TTH503

Citroen



TTH504

Holden



TTH505

Holden



TTH506

Holden



TTH507

Holden



TTH508

Holden



TTH509

Holden



TTH510

Daewoo



TTH511

Daewoo



TTH512

Citroen



TTH513

BMW



TTH514

BMW



TTH515

BMW



TTH516

Holden



TTH517

Fiat

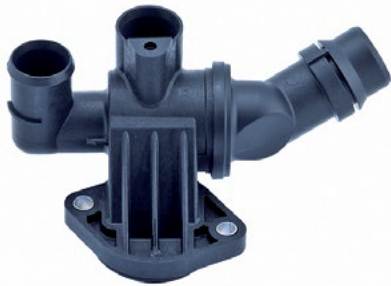

TTH518

Volkswagen



TTH519

Volvo



TTH520

Seat

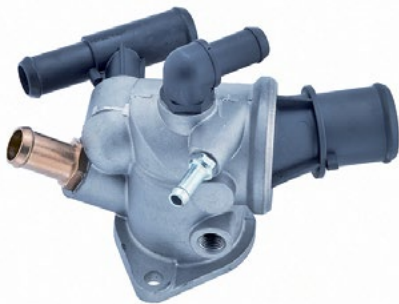

TTH521

Alfa Romeo



TTH523

Citroen



TTH524

Holden



TTH525

Holden



TTH527

BMW



TTH528

Alfa Romeo



TTH530

Volvo



TTH531

Alfa Romeo



TTH532

Citroen





TTH533

Fiat



TTH534

Alfa Romeo



TTH535

Volkswagen



TTH537

Alfa Romeo



TTH540

Volvo



TTH541

Citroen



TTH542

Citroen



TTH543

Citroen



TTH546

Holden



TTH547

Volkswagen



TTH548

Holden



TTH549

Daewoo



TTH550

Toyota



TTH551

BMW



TTH553

BMW



TTH564

Lexus



TTH565

Suzuki



TTH566

Honda



TTH567

Honda



TTH568

Honda



TTH570

Nissan



TTH571

Hyundai



TTH574

Mercedes



TTH575

Mercedes



TTH576

Mercedes



TTH577

Mercedes



TTH578

Ford



TTH579

Nissan



TTH580

Volkswagen





TFK003

Mitsubishi



TFK005

Daewoo



TFK006

Holden



TFK008

Daewoo



TFK009

Daewoo



TFK011

Holden



TFK012

Holden



TFK013

Holden



TFK016

Holden



TFK019

Toyota



TFK020

Toyota



TFK021

Toyota



TFK028

Holden



TFK038

Honda



TFK040

Honda

# Timing Belt Kits

# TRU-FLOW



TFK041

Ford



TFK044

Honda



TFK045

Ford



TFK048

Ford



TFK049

Ford



TFK050

Ford

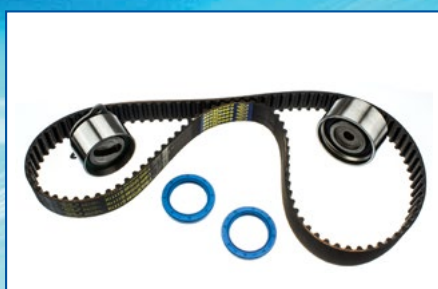

TFK051

Ford



TFK052

Ford

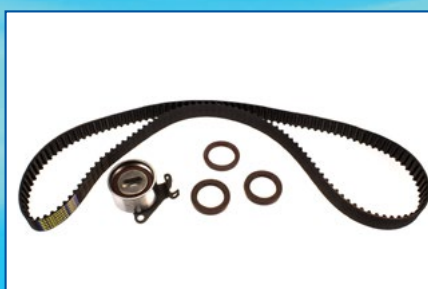

TFK058

Hyundai

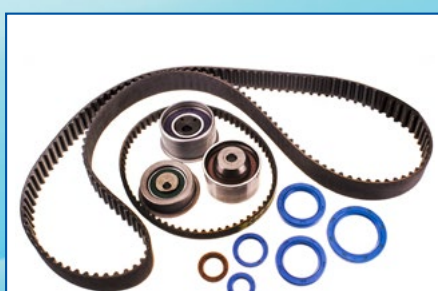

TFK059

Hyundai



TFK063

Hyundai



TFK064

Mitsubishi

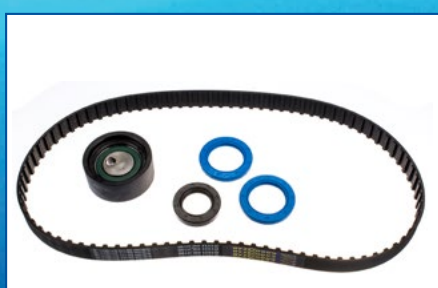

TFK067

Holden

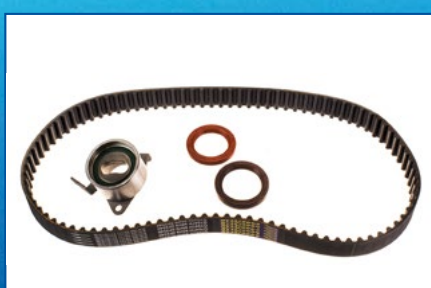

TFK072

Daihatsu



TFK073

Daihatsu





TFK075

Subaru



TFK075H

Subaru



TFK079

Holden



TFK080

Mitsubishi



TFK082

Hyundai



TFK083

Toyota



TFK090

Toyota



TFK093

Holden



TFK094

Nissan



TFK096

Mitsubishi



TFK099

Mitsubishi



TFK099H

Mitsubishi



TFK100

Toyota



TFK100H

Lexus



TFK100H1

Lexus



TFK107

Mitsubishi



TFK104

Mitsubishi



TFK111

Toyota



TFK112

Ford



TFK113

Mitsubishi



TFK113H

Mitsubishi



TFK116

Daewoo



TFK122

Daewoo



TFK123

Mitsubishi



TFK124

Hyundai



TFK125

Suzuki



TFK127

Honda



TFK133

Mitsubishi



TFK138

Honda



TFK140

Honda





TFK147

Nissan



TFK153

Toyota



TFK153H

Toyota



TFK155

Ford



TFK160H

Subaru



TFK161H

Subaru



TFK168

Holden



TFK170

Toyota



TFK171

Toyota



TFK173

Nissan



TFK175

Hyundai



TFK177

Hyundai



TFK178

Hyundai



TFK180

Kia



TFK181

Kia

# Timing Belt Kits

# TRU-FLOW

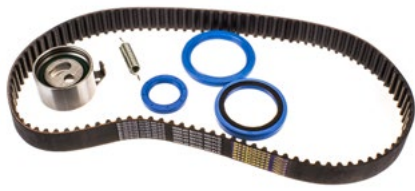

TFK192

Ford



TFK193

Ford



TFK218

Honda



TFK220

Honda



TFK221

Daihatsu



TFK009P

Daewoo



TFK005P

Daewoo



TFK008P

Daewoo



TFK012P

Holden



TFK012PC

Holden



TFK013P

Holden



TFK013PC

Holden



TFK015P

Holden



TFK015PC

Holden



TFK016P

Holden





TFK016PC

Holden



TFK045P

Ford



TFK048P

Ford



TFK049P

Ford

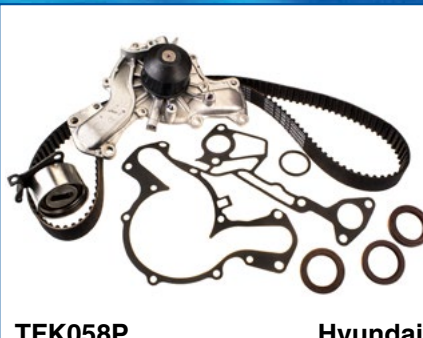

TFK058P

Hyundai



TFK058PC

Mitsubishi



TFK058PC1

Mitsubishi



TFK075HP

Subaru



TFK082P

Hyundai



TFK093P

Holden



TFK093P2

Holden



TFK099HPC

Mitsubishi



TFK099P

Mitsubishi



TFK099PC

Mitsubishi



TFK107P

Mitsubishi



# Timing Belt Kits

# TRU-FLOW



TFK112P

Ford



TFK113HP

Mitsubishi



TFK116P

Daewoo



TFK124P

Hyundai



TFK127P

Honda



TFK128

Mitsubishi



TFK128H

Mitsubishi



TFK153HPC

Toyota



TFK160HP

Subaru



TFK160HP1

Subaru



TFK175P

Hyundai



TFK177P

Hyundai



TFK180P

Kia



TFK186

Holden



TFK195

Mitsubishi





TFK196

Mitsubishi



TFK221H

Toyota



TFK221P1

Toyota



TFK221P2

Toyota



TFK284P

Hyundai



TFK299

Honda



TFK4018H

Mitsubishi



TFK4018HC

Mitsubishi



TFK4042

Holden

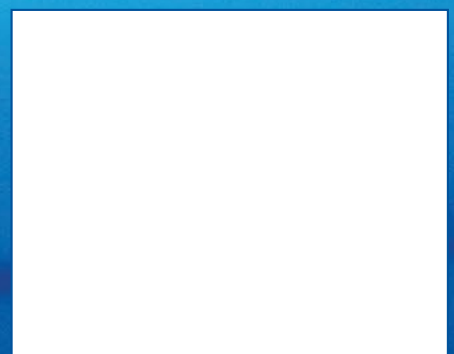
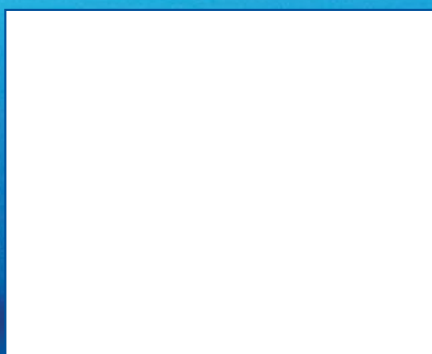
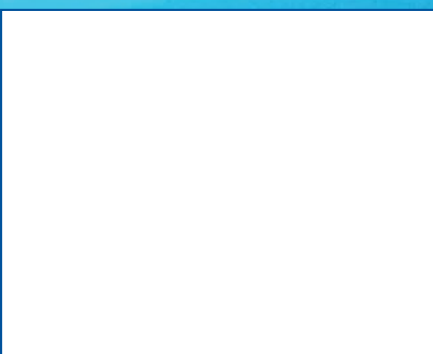
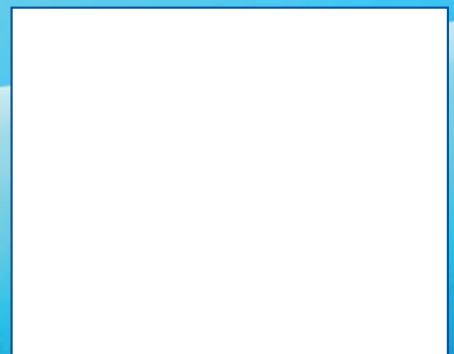
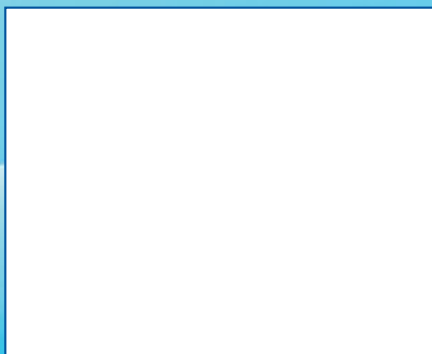
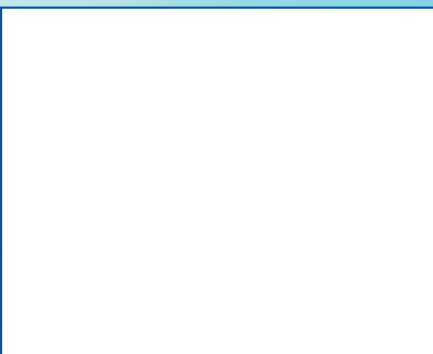
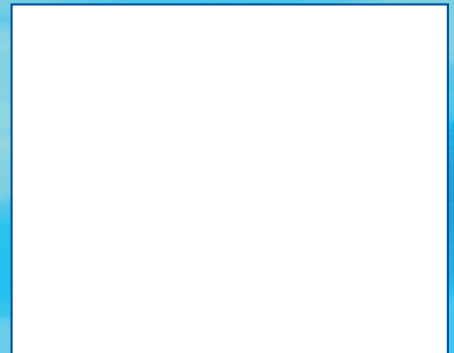
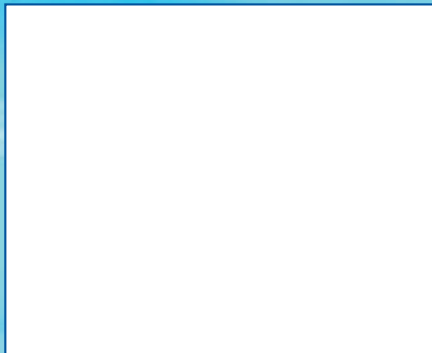





TFT1908 Universal 5/8 Straight



TFT1909 Universal 3/4 Straight



TFT2005 Holden



TFT2007 Holden



TFT4008 Universal 5/8 Inline



TFT5104 Holden



TFT5105 Holden



TFT5202 Ford



TFT5213 Ford



TFT5217 Ford



TFT5631 Holden



TFT6315 Ford



TFT6860 Universal



TFT7000 Toyota



TFT7001 Toyota



TFT7002

Toyota



TFT7003

Toyota



TFT7004

Toyota



TFT7005

Nissan



TFT7006

Mitsubishi



TFT7007

Mitsubishi



TFT7008

Mitsubishi

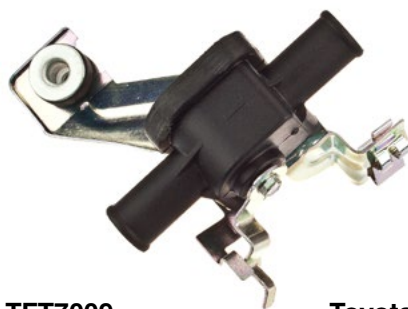

TFT7009

Toyota



TFT7010

Toyota



## Corrosion, Contamination or Cavitation Damage

### Cause

- **Not using pure water**
- **Not Flushing Cooling system correctly**
- **Re-using old coolant**
- **Incorrect ratio of coolant to pure water**
- **Incorrect or insufficient bleeding of air from cooling system**

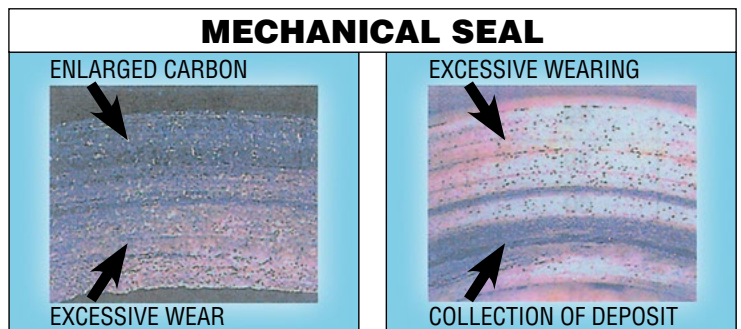
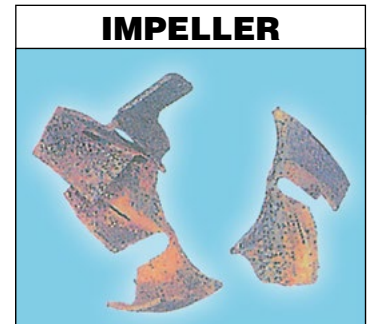
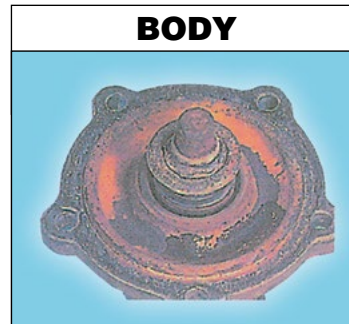

- Prevention**
- **Never reuse old coolant**
  - **Never fill cooling system with water only**
  - **Always flush cooling system (*including heater core*) before fitting new water pump.**
  - **Always use the correct coolant in the appropriate ratio of pure water.**
  - **Always correctly bleed the cooling system. Re-check / re-bleed after engine has been run with new pump.**

## **Bearing Collapse / Shaft Damage**

- Cause**
- **Drive Belt Overtightened**
  - **Faulty Fan or Fan Clutch Assembly**

- Prevention**
- **Tension drive belt to manufacturers specifications – *do not overtighten the drive belt***
  - **Replace fan / fan clutch when fitting new pump**

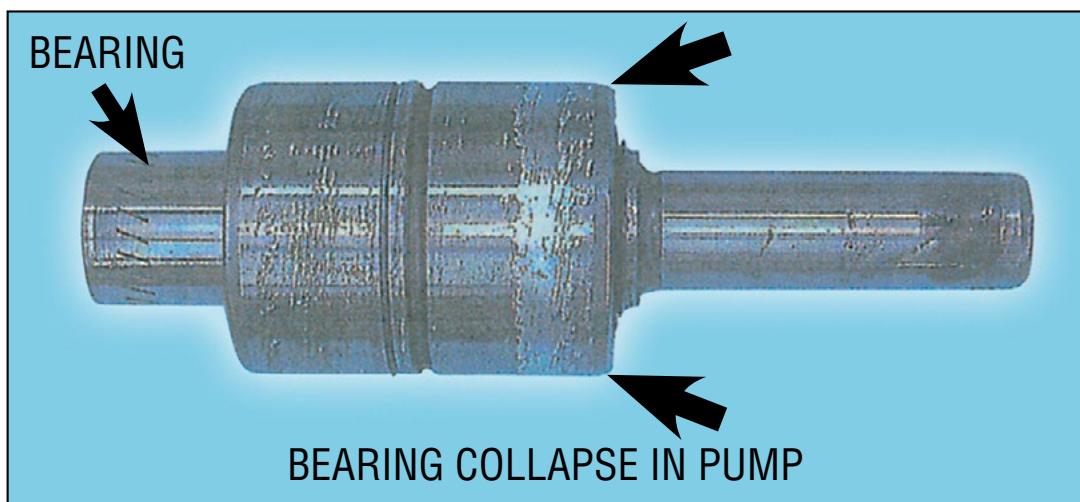

## COMMON WATER PUMP FAILURES AND THEIR CAUSES

### LEAKING OR SEEPAGE FROM THE WEEP HOLE

Leaking or seepage from the weep hole is a sure sign of seal failure. The life of the seal can be greatly extended by performing regular maintenance of your cooling system. Periodic inspection of hoses and coolant recovery tank will assure coolant levels are correct and that no atmospheric contaminants that can cause oxidation and sludge build-up are present. Sludge build-up in the cooling system is a primary cause of seal failure as well as reduced cooling system efficiency.

The water pump seal is delicate, rust and core residue will cause the seal to corrode and leak prematurely.

### NOISE NEAR THE WATER PUMP

Often noises are mistaken as being the water pump when in most cases they are caused by slippage of the fan belt on the pulleys (refer to fan belt tension). In rare cases if the noise is from the water pump, by adding soluble oil into the radiator may eliminate this problem. It is common when checking a water pump and turning it by hand that it makes a squeaking sound from the mechanical seal area. This disappears when the pump is filled with water.

#### Reason:

Since noises are often caused by fan belt slippage it is important that quality fan belts are used.

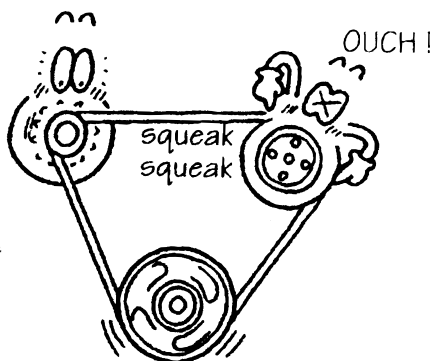

### FAN CLUTCHES

When a water pump fails, the fan clutch fails.

The water pump and fan clutch share the same shaft. Should the water pump bearing fail, the fan clutch bearing generally also fails and both must be replaced.

The fan clutch is designed to "drive" the fan blade when air is needed to cool the engine. It is also designed to take fan blade "load" from the engine when additional air movement is not needed.

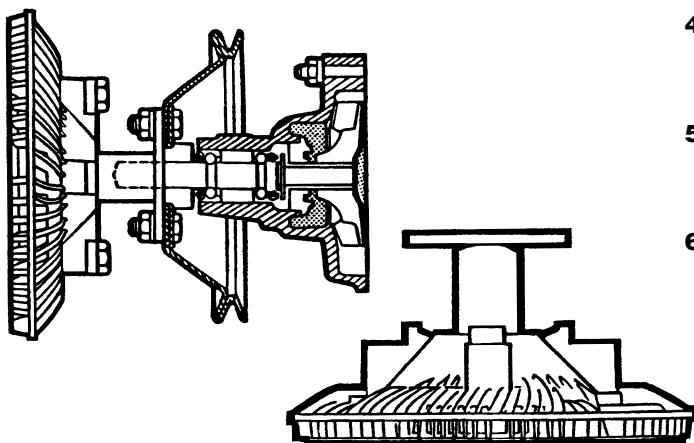

### FAN BELT TENSION

Problems will arise if the fan belt tension is too loose or too tight. Ensure the correct tools are used for the job and adjust the fan belt to the correct tension specified by the vehicle manufacturer.

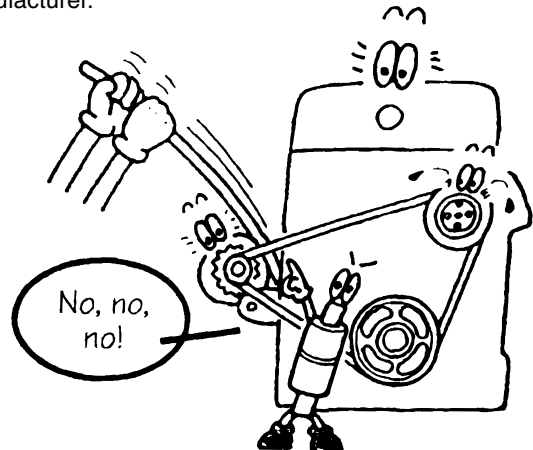

#### Reason:

If the belt tension is too great it will result in overloading the water pump bearing, causing premature failure and possible cracking of the pump casing. Insufficient tension will result in overheating as the belt slippage on the water pump will not circulate the correct volume of water required to cool the engine.

### BROKEN WATER PUMP HOUSINGS AND SHAFTS ARE COMMONLY CAUSED BY EXCESSIVE VIBRATION AND UNBALANCE DUE TO:

- Bent, cracked or broken fan;
- Fan not squarely mounted on the shaft;
- Cracked or bent pulleys due to improper installation.

#### Replace the fan clutch when:

1. **Engine overheating** – fan spins freely – does not engage.
2. **Excessive fan clutch play** – manually move the fan back and forth. If there is more than 1/4" play the clutch bearing is worn.
3. **Greasy build up** – Look for greasy dirt on the fan clutch. Check for fluid leakage around the outer edge and at centre of thermostat spring.
4. **Excessive slippage** – A hot engine in the "off" position which allows easy revolving of the fan manually, from 1 to 1 revolutions indicates a weak clutch.
5. **Freezing up** – If the fan blade cannot be rotated by hand, or if hand rotation makes a harsh, rumbling noise, the fan clutch bearing has failed.
6. **Shaft vibration** – The fan clutch is mounted on the water pump between the water pump shaft and the fan. Any vibration can mean a worn bearing in the water pump or fan clutch. Since the fan clutch and water pump have about the same life span, it generally makes sense to replace both at the same time. Unless there are obvious signs of damage, it is seldom necessary to replace the fan when installing a new clutch.







ABN 97 097 993 283

Australia

2C Glendenning Road  
Glendenning NSW 2761

Phone 1800 605 673

[www.truflow.com.au](http://www.truflow.com.au)

New Zealand

278 Church Street  
Penrose Auckland 1061

Phone 0800 809 808

[www.motospecs.co.nz](http://www.motospecs.co.nz)

▲ INDEX

*Distributed by...*

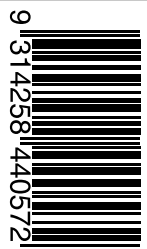

CAT-TF4